

Product Information

FLEX-LC

Level Transmitter / Switch FLEX-LC



- Level sensor with Reed chain
- Analog output and/or switching output
- Alternatively with temperature sensor
- Various materials available
- Designed for industrial use
- Small, compact construction
- Very simple installation

Characteristics

A float fitted with a magnet affects a Reed chain within the guide tube; the chain is connected as a potentiometer with resistances. The resolution is 10..20 mm and is highly reproducible. The FLEX sensor electronics use a microcontroller to convert the potentiometer values into standardised outputs, and offer both an analog and a switching output. A temperature sensor can optionally be integrated, and its measured value can be output either via the analog output or the switching output.

Technical data

Switch	reed switch chain with float fitted with magnet
Mechanical Connection	FLEX-LC45M G 1 A FLEX-LC44M G 1½ A FLEX-LC52K G 2 A
For metering ranges, lengths and divisions	see "Ranges, dimensions and weights"

Pressure resistance	FLEX-LC45M PN 20 bar FLEX-LC44M PN 20 bar FLEX-LC52K PN 40 bar
Medium temperature	-20..+105 °C
Ambient temperature	-20..+70 °C
Storage temperature	-20..+80 °C
Density of medium	FLEX-LC45M ³ 0.34 g/cm³ FLEX-LC44M ³ 0.44 g/cm³ FLEX-LC52K ³ 0.66 g/cm³
Supply voltage	18..30 V DC
Power consumption	< 100 mA
Analog output	4..20 mA or 0..10 V DC
Switching output	transistor output "push-pull" (resistant to short circuits and polarity reversal) I _{out} = 100 mA max.
Switching hysteresis	approx. 2 % or option, not smaller than division, position dependent on characteristics (minimum or maximum)
Display	yellow LED for switching output: On = Normal / Off = Alarm , otherwise displays operating voltage
Electrical connection	for round plug connector M12x1, 4-pole
Materials medium-contact	FLEX-LC45M CW614N and Spansil FLEX-LC44M CW614N and Spansil FLEX-LC52K Stainless steel 1.4404
Materials, non-medium-contact	stainless steel 1.4305, PA 6.6
Ingress protection	IP 67
weights	see "Ranges, dimensions and weights"
Conformity	CE

Wiring

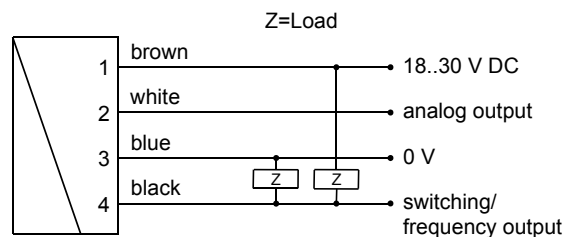

Connection example: PNP NPN

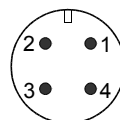

Before the electrical installation, it must be ensured that the supply voltage corresponds with the data sheet. It is recommended to use shielded wiring.

Product Information

FLEX-LC

Ranges, dimensions and weights

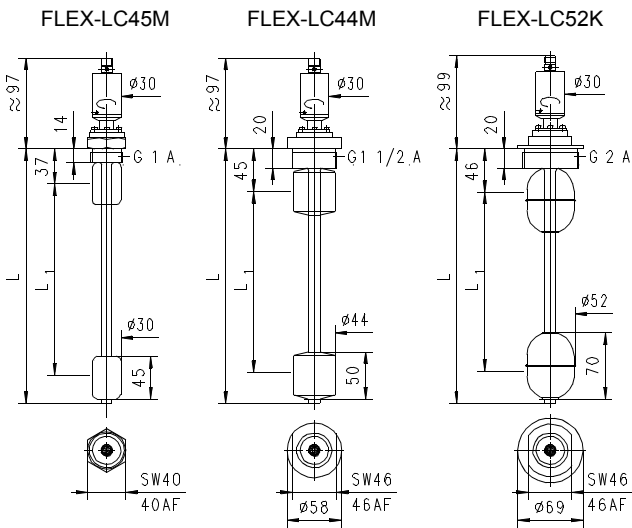

Types FLEX-	Division mm	L mm	L1 mm	Weight kg
LC45M0250	10	250	190	0.6
LC45M0500		500	440	0.7
LC45M0750		750	690	0.7
LC45M1000		1000	940	0.8
LC44M1000	20	1000	930	0.8
LC44M1500		1500	1430	0.9
LC44M2000		2000	1930	0.9
LC52K0250	10	250	160	1.1
LC52K0500		500	410	1.1
LC52K0750	20	750	660	1.1
LC52K1000		1000	910	1.2
LC52K1500		1500	1410	1.2
LC52K2000		2000	1910	1.2

Handling and operation

Note:

Not suitable for use in media with ferritic particles.

Installation

Installation is carried out by screwing the sensor into a suitable threaded drilling on the upper side of the container. A flat seal is included in the scope of the delivery.

Programming

The electronics contain a magnetic contact, with the aid of which different parameters can be programmed. Programming takes place when a magnet clip is applied for a period between 0.5 and 2 seconds to the marking located on the label. If the contact time is longer or shorter than this, no programming takes place (protection against external magnetic fields).



After the programming ("teaching"), the clip can either be left on the device, or removed to protect data.

The device has a yellow LED which flashes during the programming pulse. During operation, the LED serves as a status display for the switching output.

In order to avoid the need to transit to an undesired operating status during "teaching", the device can be provided ex-works with a "teach-offset". The "teach-offset" value is added to the currently measured value before saving (or is subtracted if a negative value is entered).

Example: The switching value is to be set to 70 % of the metering range, because at this flow rate a critical process status is to be notified. However, only 50 % can be achieved without danger. In this case, the device would be ordered with a "teach-offset" of +20 %. At 50 % in the process, a switching value of 70 % would then be stored during "teaching".

Normally, programming is used to set the limit switch. However, if desired, other parameters such as the end value of the analog or frequency output may also be set.

The limit switch can be used to monitor minimal or maximal.

With a minimum-switch, falling below the limit value causes a switchover to the alarm state. Return to the normal state occurs when the limit value plus the set hysteresis is again exceeded.

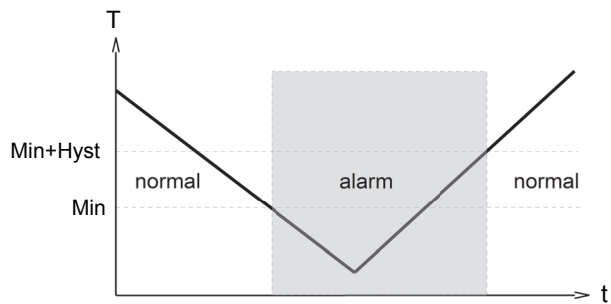

With a maximum-switch, exceeding the limit value causes a switchover to the alarm state. Return to the normal state occurs when the measured value once more falls below the limit value minus the set hysteresis.

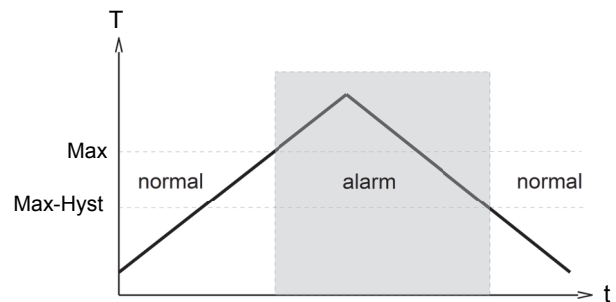

A switchover delay time (t_{DS}) can be applied to the switchover to the alarm state. Equally, one switch-back delay time (t_{DR}) of several can be applied to switching back to the normal state.

Product Information

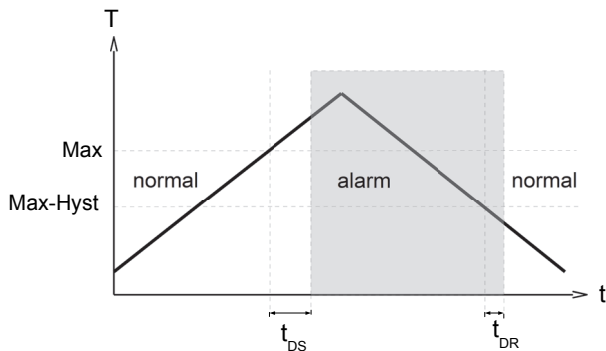

In the normal state the integrated LED is on, in the alarm state it is off, and this corresponds to its status when there is no supply voltage.

In the non-inverted (standard) model, while in the normal state the switching output is at the level of the supply voltage; in the alarm state it is at 0 V, so that a wire break would also display as an alarm state at the signal receiver. Optionally, an inverted switching output can also be provided, i.e. in the normal state the output is at 0 V, and in the alarm state it is at the level of the supply voltage.

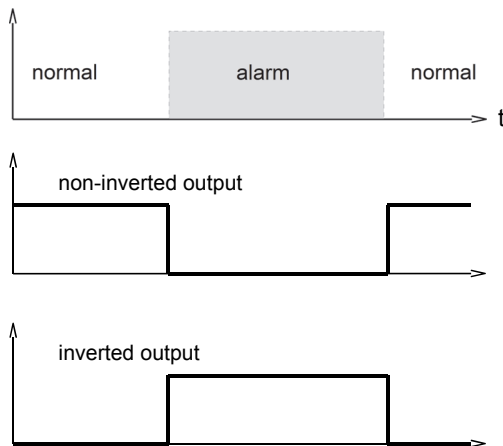

A Power-On delay function (ordered as a separate option) makes it possible to maintain the switching output in the normal state for a defined period after application of the supply voltage.

Combinations with FLEX

FLEX-evaluation electronics can be combined with very different types of pickup systems for flow rate, level, temperature, and pressure. This has created a family of sensors with which different types of applications can be supported.



Ordering code

FLEX-LC - 1. 2. 3. 4. 5. 6.

○=Option

1. Version	
45M	screw-in fitting G 1 A brass - float Spansil
44M	screw-in fitting G 1 1/2 A brass - float spansil
52K	screw-in fitting G 2 A stainless steel
2. Tube length L	
0250	250 mm
0500	500 mm
0750	750 mm
1000	1000 mm
1500	1500 mm
2000	2000 mm
3. Analog output for	
I	4..20 mA
U	0..10 V
K	no analog output
4. Switching output	
L	level
T	temperature
K	No analog output
5. Switching output	
T	push-pull (PNP and NPN)
K	no switching output
6. Switching output for	
L	push-pull (PNP and NPN)
T	temperature
K	no switching output
7. Switching output function	
L	minimum-switch
H	maximum-switch
R	frequency output
K	no switching output
8. Switching output level	
O	standard
I	inverted

Product Information

Options

Special lengths and divisions available on request.

Special measuring range for temperature:

Maximum 120 °C (standard = 70 °C) °C

Minimum -20 °C (standard = 0 °C) °C

End frequency (max. 2000 Hz) Hz

Switching delay (from Normal to Alarm) . s

Switchback delay . s

(from Alarm to Normal)

Power-On delay (0..99 s) s

(time after power on, during which the outputs are not actuated)

Switching output fixed °C/mm

Special hysteresis (standard = 2 % EW) %

If the field is not completed, the standard setting is selected automatically.

Accessories

- Cable/round plug connector
- Device configurator ECI-1 (KB...) see additional information "Accessories"