

Product Information

**Flow Transmitter
 LABO-CF-I / U / F / C**



- Flow measurement device using the vortex measurement principle
- High precision
- High overload protection
- No moving parts
- Rapid installation and removal thanks to clamp fastening
- Various connections using building block system
- 0..10 V, 4..20 mA, frequency/pulse output, completely configurable

Characteristics

A narrow triangular body (1), which goes through the complete cross-section of the measurement pipe, creates vortices in the medium when there is a flow (Kármán vortex street, vortex effect). The frequency of the vortex is proportional to the flow, and is detected using a piezo-sensor (2), which lies behind the triangular body. The complete unit, vortex body, and detector are designed as a plug-in unit (3), and are inserted into the pipe. Here, a lightning fast separation between measurement pipe and the complete measurement unit is possible.

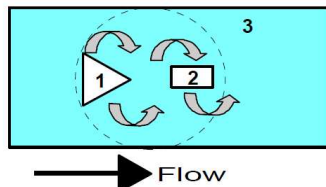

The integrated converter / counter make available an electronic switching output (push-pull) with adjustable characteristics (minimum/maximum) and hysteresis, which responds when an adjustable limit is fallen short of or exceeded.

The switching value can be set to the currently existing flow using "teaching".

Models with analog or pulse output are also available.

Technical data

Sensor	vortex principle
Nominal width	DN 8..25
Process connection	female thread G 1/4..G 1 (others available on request)
Metering ranges	0.9..150 l/min for details, see table "Ranges"
Measurement accuracy	up to 50 % of full scale value: ±1 % of measured value from 50 % of full scale value: ±2 % of measured value
Pressure resistance	PN 10 bar

Media temperature	0..60 °C	
Ambient temperature	-20..+70 °C	
Materials medium-contact	Housing	CW614N plated, 1.4571 or POM GF
	Connection	CW614N plated, 1.4571 or POM
	Detector Seal	ETFE PA6T6I 40 % GF EPDM
Supply voltage	10..30 V DC voltage output 10 V: 15..30 V DC	
Power consumption	< 1 W (without load)	
Output data:	all outputs are resistant to short circuits and reversal polarity protected	
	Current output:	4..20 mA (0..20 mA available on request)
	Voltage output:	0..10 V (2..10 V available on request) output current max. 20 mA
	Frequency output:	transistor output "push-pull" I _{out} = 100 mA max.
	Pulse output:	transistor output "push-pull" I _{out} = 100 mA max. pulse width 50 ms pulse per volume is to be stated
Display	yellow LCD shows operating voltage (LABO-CF-I / U) or output status (LABO-CF-F / C) or (rapid flashing = Programming)	
Electrical connection	for round plug connector M12x1, 4-pole	
Ingress protection	IP 67	
Weight	see table "Dimensions"	
Conformity	CE	

Ranges

G	Types	Range l/min H ₂ O
G 1/4	LABO-CF-008	0.9.. 15 l/min
G 3/8	LABO-CF-010	1.8.. 32 l/min
G 1/2	LABO-CF-015	3.5.. 50 l/min
G 3/4	LABO-CF-020	5.0.. 85 l/min
G 1	LABO-CF-025	9.0..150 l/min

... professional Instruments "MADE IN GERMANY"

Product Information

Signal output curves

Value x = Begin of the specified range

= not specified range

Current output

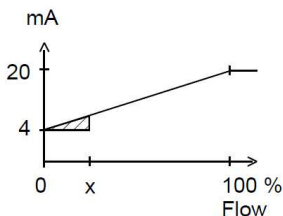

Voltage output

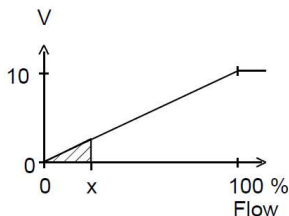

Frequency output

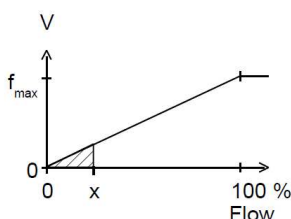

f_{max} selectable in the range of up to 2000 Hz

Other characters on request.

Wiring

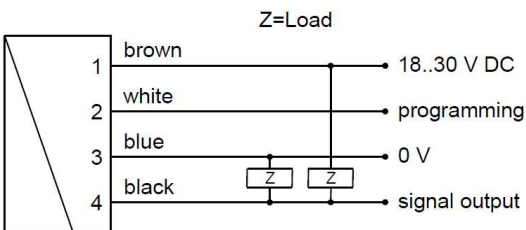

Connection example: PNP NPN

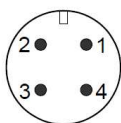

Before the electrical installation, it must be ensured that the supply voltage corresponds with the data sheet. It is recommended to use shielded wiring

Dimensions

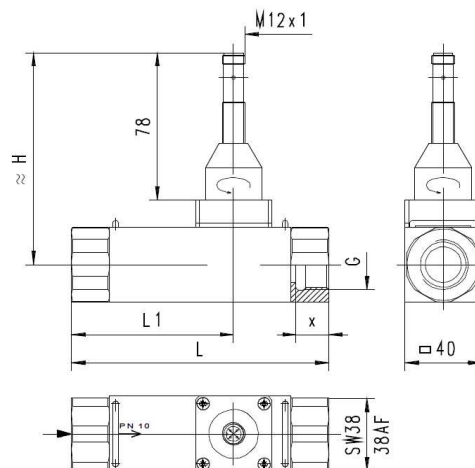

G	DN	Types	H	L	L1	X	Weight* kg
G 1/4	DN 8	LABO-CF-008	111	125	69	12.5	1.62
G 3/8	DN 10	LABO-CF-010	109	100	50		1.27
G 1/2	DN 15	LABO-CF-015	111			14.5	1.27
G 3/4	DN 20	LABO-CF-020	113	135	85	16.5	1.67
G 1	DN 25	LABO-CF-025	115	155	95	18.5	1.47

*Weight details for metal model. Plastic models available on request

Handling and operation

Installation

The vortex flow meter requires a run-in length of 5..10 x D in order to achieve its specified accuracy. If deposits are to be expected, sensor and electronics should not be installed underneath. It should be ensured that the sensor is installed in the direction of the flow arrow. If the sensor is to be cleaned, the clamps should be released, and the device removed (the pipe should be pressure-free for this). It should be ensured during cleaning that the oscillating vortex body is not exposed to impact (in the moulded part there is a sensitive piezo-ceramic sensor, which can break).

Note

The metering range end value can be programmed by the user via "teaching". Requirement for programmability must be stated when ordering, otherwise the device cannot be programmed.

The ECI-1 device configurator with associated software is available as a convenient option for programming all parameters by PC, and for adjustment.

The teaching option is not available for the pulse output version.

Operation and programming

The teaching process can be carried out by the user as follows:

- The flow rate to be set is applied to the device.
- Apply an impulse of at least 0.5 seconds and max. 2 seconds duration to pin 2 (e.g. via a bridge to the supply voltage or a pulse from the PLC), in order to accept the measured value.
- When the teaching is complete, pin 2 should be connected to 0 V, so as to prevent unintended programming.

The devices have a yellow LED which flashes during the programming pulse. During operation, the LED serves as an indicator of operating voltage (for analog output) or of switching status (for frequency or pulse output).

... professional Instruments "MADE IN GERMANY"

Product Information

To avoid the need to transit to an undesired operating status for the purpose of teaching, the device can be provided ex-works with a teach-offset. The teach-offset point is added to the currently measured value before saving. The offset point can be positive or negative.

Example: The end of the metering range should be set to 80 l/min. However, it is possible only to reach 60 l/min without problems. In this case, the device would be ordered with a teach-offset of +20 l/min. At a flow rate of 60 l/min in the process, teaching would then store a value of 80 l/min.

Ordering code

The basic device is ordered e.g. CF-xxx
 with electronics e.g. LABO-CF-xxx

CF- 1. 2. 3. 4. 5. 6. 7.
 E **E**

LABO-CF- 8. 9. 10. 11.

○=Option

1. Nominal width					
008	DN 8 - G 1/4				
010	DN 10 - G 3/8				
015	DN 15 - G 1/2				
020	DN 20 - G 3/4				
025	DN 25 - G 1				
2. Process connection					
G	female thread				
3. Connection material					
M	CW614N plated				
K	○ 1.4571				
P	○ POM				
4. Body material					
M	CW614N plated				
K	1.4571				
P	○ POM GF				
5. Metering range					
015	0.9.. 15 l/min				•
032	1.8.. 32 l/min				•
050	3.5.. 50 l/min				•
085	5.0.. 85 l/min				•
150	9.0..150 l/min				•
6. Seal material					
E	EPDM				
7. Connection for					
E	electronics				
8. For nominal width					
008	DN 8 - G 1/4				•
010	DN 10 - G 3/8				•
015	DN 15 - G 1/2				•
020	DN 20 - G 3/4				•
025	DN 25 - G 1				•
9. Signal output					
I	4..20 mA				
U	0..10 V				
F	frequency output (see "Ordering information")				
C	pulse output (see "Ordering information")				

10. Programming	
N	full scale value cannot be programmed (no teaching)
P	○ full scale value can be programmed (teaching possible)
11. Electrical connection	
S	for round plug connector M12x1, 4-pole

Required ordering information

For LABO-CF-...F:

Output frequency at full scale Hz
 Maximum value: 2,000 Hz

For LABO-CF-...C:

For the pulse output version, the volume (with numerical value and unit) which will correspond to one pulse must be stated.

Volume per pulse (numerical value)

Volume per pulse (unit)

Options

Special range for analog output: l/min

<= metering range (standard=metering range)

Special range for frequency output: l/min

<= metering range (standard=metering range)

Power-On delay period (0..99 s) s

(time after applying power during which the outputs are not actuated or set to defined values)

Further options available on request.

Accessories

- Cable/round plug connector (KB...) see additional information "Accessories"
- Converter / counter OMNI-TA
- Device configurator ECI-1

... professional Instruments "MADE IN GERMANY"