

Produktinformation

Flow Transmitter / Switch Screw Volumeter OMNI-VHS



- Measures and monitors viscous media (oil) 1.4..2500 l/min
- Connection G 1..G 2 1/2
- Very low dependence on viscosity
- Can be used up to 40,000 mm²/s (cSt)
- Light and compact device (aluminium housing)
- Operation and measurement possible with forwards and reverse flow
- For cost-sensitive applications
- Analog output 4..20 mA or 0..10 V
- Two programmable switches
- Graphical LCD display, backlit, can be read in sunlight and in the dark
- Selectable units in the display
- Programmable parameters via rotatable, removable ring (programming protection)
- Electronics housing with non-scratch, chemically resistant glass
- Rotatable electronic housing for best reading position
- Designed for industrial use
- Small, compact construction
- Simple installation

Characteristics

The VHS flow transmitter measures the flow using the volumetric principle, and is suitable for fluid, viscous, lubricant media (e.g. lubricating oil). If the material for the VHS is selected appropriately, aqueous fluids such as soaps, pastes, and emulsions with non-abrasive characteristics can also be measured, as long as they have sufficient lubricity. Because of the volumetric functioning principle, the device is almost completely independent of viscosity.

The VHS system consists of two interlacing screws which run in opposite directions, driven by the flowing medium. A magnetically pre-tensioned Hall sensor positioned outside the flow space detects the screw flanks, and creates a frequency signal proportional to the flow. Here, every pulse corresponds to a specific measured volume. There are no magnets in the flow space.

The OMNI transducer located on the sensor has a backlit graphics LCD display which is very easy to read, both in the dark and in bright sunlight. The graphics display allows the presentation of measured values and parameters in a clearly understandable form. The measured values are displayed to 4 places, together with their physical unit, which may also be modified by the user. The

electronics have an analog output (4..20 mA or 0..10 V) and two switching outputs, which can be used as limit switches for monitoring minimal or maximal, or as two-point controllers. The switching outputs are designed as push-pull drivers, and can therefore be used both as PNP and NPN outputs. Exceeding limit values is signalled by a red LED which is visible over a long distance, and by a cleartext in the display. The stainless steel case has a hardened non-scratch mineral glass pane.

It is operated by a programming ring fitted with a magnet, so there is no need to open the operating controls housing, and its leakproofness is permanently ensured.

By turning the ring to right or left, it is simple to modify the parameters (e.g. switching point, hysteresis...). To protect from unintended programming, it can be removed, turned through 180 ° and replaced, or completely removed, thus acting as a key.



OPTION C:

Preset Counter with external reset option, complementary switching outputs and actual value display.

OPTION C1:

Instantaneous value display with analogue output, pulse-volume output and totalizer

Technical data

Sensor	screw volumeter		
Nominal width	DN 25..65		
Process connection	female thread G 1..G 2 1/2		
Metering ranges	see table "Ranges and weights"		
Measurement accuracy	±1 % of the measured value (at 20 mm²/s, (cSt) of 1 %..100 % nominal working range (see also diagram in		
Repeatability	±0,25 %		
Pressure resistance	Connection material	SAE flange	PN bar
	Aluminium	without	160
	Aluminium	with	350
	Steel	without	350
	Steel	with	350
	others available on request		
Pressure loss	see diagram in upstream pages		
Medium	oil or non-aggressive self-lubricating fluids		
Medium temperature	-25..+80 °C (150 °C available on request)		

... professional Instruments "MADE IN GERMANY"

Produktinformation

Materials medium-contact	(special materials available on request):
1. Body	Aluminium 6082 anodised
2. Connections:	Aluminium 6082 anodised or steel
3. Main screw	Stahl 35SMnPb10 UNI 4838-80
4. Subsidiary screw	GHISA GJL-250 EN1561
5. Ball bearing	Steel
6. Ball bearing	Steel
7. Screws	Galvanised steel
8. O-ring	NBR
9. Seeger ring	Steel
10. Seeger ring	Steel
11. O-ring	NBR
12. SAE connection	ASTM A216WCB
13. SAE flange	ASTM A216WCB

14. O-ring	NBR	
15. Screws	Galvanised steel	
16. Sensor spacer	Aluminium 6082 anodised	
Materials non-medium-contact	Electronics housing	stainless steel 1.4305
	Glass	mineral glass hardened
	Magnet Ring	samarium-Cobalt POM
Supply voltage	18..30 V DC	
Power consumption	< 1 W	
Analog output	4..20 mA / max. load 500 Ω or 0..10 V / min. load 1 kΩ	
Switching outputs	transistor output "push-pull" (resistant to short circuits and polarity reversal) I _{out} = 100 mA max.	
Hysteresis	adjustable, position of the hysteresis depends on minimum or maximum	
Display	backlit graphical LCD-Display (transreflective), extended temperature range -20..+70 °C, 32 x 16 pixels, background illumination, displays value and unit, flashing LED signal lamp with simultaneous message on the display.	
Electrical connection	for round plug connector M12x1, 5-pole	
Ingress protection	IP 67 / (IP 68 when oil-filled)	
Weight	see table "Weights"	
Conformity	CE	

Signal output curves

Value x = Begin of the specified range
 = not specified range

Current output

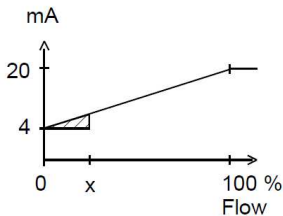

Voltage output

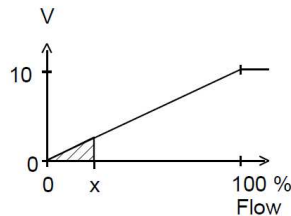

Other characters on request.

Ranges and weights

● = Standard ○ = Option

G	DN	●	Metering range 1..100 % Q _{nom}	Volume / pulse	Types	Q _{max} recommended	Weights		
							Body with aluminium connections	Body with steel connections	SAE Flanges (Weight per pair)
			l/min	cm ³		l/min	kg	kg	kg
G 1	DN 25	●	1.4.. 140	13.10	OMNI-VHS-025.....0140	200	3.44	4.76	5.76
G 1 ^{1/4}	DN 32	●	3.5.. 350	29.00	OMNI-VHS-032.....0350	500	6.35	8.50	9.55
G 1 ^{1/2}	DN 40	○	5.5.. 550	48.58	OMNI-VHS-040.....0550	800	10.50	13.60	15.10
		●	8.0.. 800	72.00	OMNI-VHS-040.....0800	1200	14.20	18.50	18.80
G 2	DN 50	○	10.0..1000	103.63	OMNI-VHS-050.....1000	1600	20.70	27.70	30.30
		●	15.0..1500	133.00	OMNI-VHS-050.....1500	2200	25.00	33.20	34.60
G 2 ^{1/2}	DN 65	●	25.0..2500	238.82	OMNI-VHS-065.....2500	3800	42.70	56.10	60.70

... professional Instruments "MADE IN GERMANY"

Produktinformation

Wiring

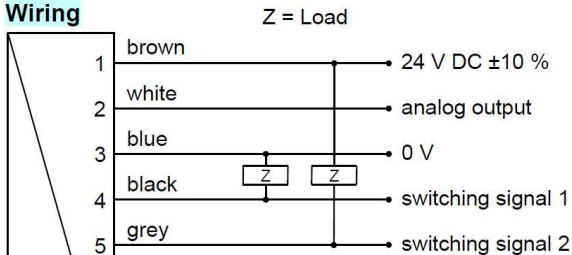

Connection example: PNP NPN

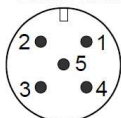

Before the electrical installation, it must be ensured that the supply voltage corresponds to the data sheet.

The use of shielded cabling is recommended.

Dimensions

● = Standard ○ = Option

G	DN...ranges	x1	L1	ØD	SW	A	VHS-...GAO....				VHS-...GAX....				
							M	x2	B	C	L2	H	E	F	
G 1	025...0140	●	20	220	88	78	49.0	12	20	57.1	27.8	324	52	80	69
G 1 1/4	032...0350	●	22	285	103	-	55.0	14	22	66.7	31.6	381	48	94	77
G 1 1/2	040...0550	○	24	332	122	-	58.8	16	24	79.4	36.5	448	58	106	89
	040...0800	●		340	138	-	66.5					456			
G 2	050...1000	○	33	396	155	-	71.0	20	35	96.8	44.4	544	74	135	116
	050...1500	●		405	168	-	77.3					553			
G 2 1/2	065...2500	●	35	475	203	-	86.0	24	42	123.8	58.7	633	79	166	150

VHS-..GAO

VHS-..GAX

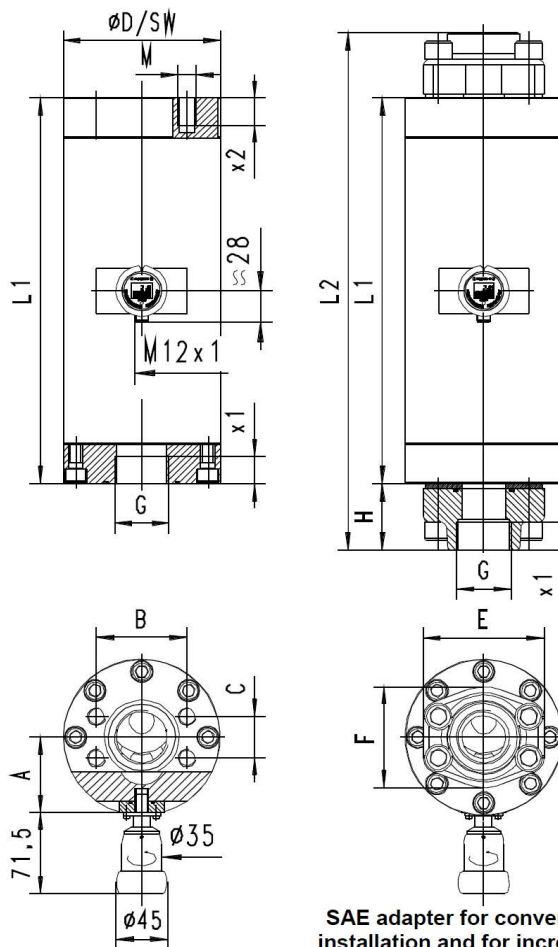

... professional Instruments "MADE IN GERMANY"

Produktinformation

Handling and operation

Installation

Any flow direction is possible during installation. Ensure that pipework is clean. Flush before installation. A 30 µm mesh filter should be used.

The use of SAE flanges enables the sensor to be installed and removed more easily, and increases the stability to pressure for every connection material at 350 bar. It is possible to replace the electronics during operation, and this presents no danger to the fitter. The sensor does not go into the flow space.

After installation, the electronic head can be turned to align the cable outlet.

Programming

The annular gap of the programming ring can be turned to positions 1 and 2. The following actions are possible:



Set to 1 = continue (STEP)
Set to 2 = modify (PROG)

Neutral position between 1 and 2

The ring can be removed to act as a key, or turned through 180 ° and replaced to create a programming protector.

Operation is by dialog with the display messages, which makes its use very simple.

Starting from the normal display (present value and unit), if 1 (STEP) is repeatedly selected, then the display shows the following information in this order:

Display of the parameters, using position 1

- Switching value S1 (switching point 1 in the selected unit)
- Switching characteristic of S1
- MIN = Monitoring of minimum value
- MAX = Monitoring of maximum value
- Hysteresis 1 (hysteresis value of S1 in the set unit)
- Switching value S2
- Switching characteristic of S2
- Hysteresis 2
- Code
- After entering the code 111, further parameters can be defined:
- Filter (settling time of the display and output)
- Physical unit (Units)
- Output: 0..20 mA or 4..20 mA
- 0/4 mA (measured value corresponding to 0/4 mA)
- 20 mA (measured value corresponding to 20 mA)

For models with a voltage output, replace 20 mA accordingly with 10 V.

Edit, using position 2

If the currently visible parameter is to be modified:

- Turn the annular gap to position 2, so that a flashing cursor appears which displays the position which can be modified.
- By repeatedly turning to position 2, values are increased; by turning to position 1, the cursor moves to the next digit
- Leave the parameter by turning to position 1 (until the cursor leaves the row); this accepts the modification
- If there is no action within 30 seconds, the device returns to the normal display range without accepting the modification.

The limit switches S1 and S2 can be used to monitor minimal or maximal.

With a minimum-switch, falling below the limit value causes a switch-over to the alarm state. Return to the normal state occurs when the limit value plus the set hysteresis is once more exceeded.

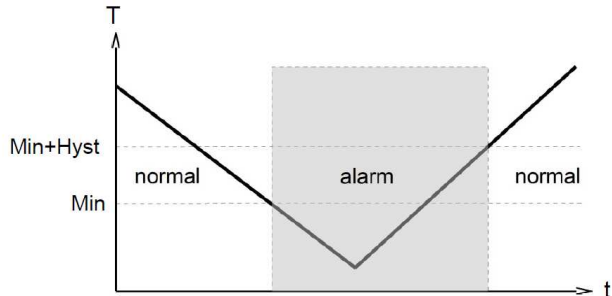

With a maximum-switch, exceeding the limit value causes a switch-over to the alarm state. Return to the normal state occurs when the measured value once more falls below the limit value minus the set hysteresis.

The change to the alarm state is indicated by the integrated red LED and a cleartext in the display.

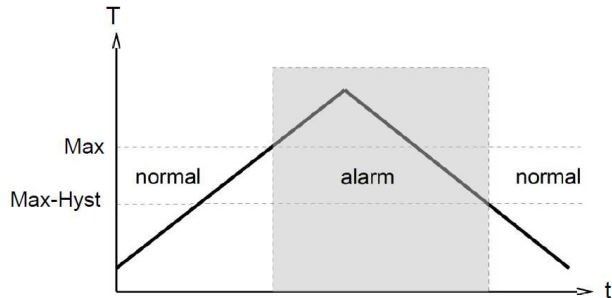

While in the normal state the switching outputs are at the level of the supply voltage; in the alarm state they are at 0 V, so that a wire break would also display as an alarm state at the signal receiver.

Overload display

Overload of a switching output is detected and indicated on the display ("Check S 1 / S 2"), and the switching output is switched off.

Simulation mode

To simplify commissioning, the sensor provides a simulation mode for the analog output. It is possible to create a programmable value in the range 0..26.0 mA at the output (without modifying the process variable). This allows the wiring run between the sensor and the downstream electronics to be tested during commissioning. This mode is accessed by means of **Code 311**.

Factory settings

After modifying the configuration parameters, it is possible to reset them to the factory settings at any time using **Code 989**.

Produktinformation

Ordering code

VHS - 1. 2. 3. 4. 5. 6. 7. 8. **G** **A** **E**

OMNI-VHS - 9. 10. 11. 12. 13. **S**

○=Option

1. Nominal width						
025	DN 25 - G 1					
032	DN 32 - G 1 1/4					
040	DN 40 - G 1 1/2					
050	DN 50 - G 2					
065	DN 65 - G 2 1/2					
2. Process connection						
G	female thread					
3. Connection material						
A	AL connection, anodised (160 bar, in combination with SAE flange: 350 bar)					
S	○ Connection, steel (350 bar)					
4. Additional flange						
X	SAE flange, steel (350 bar)					
O	no SAE flange (pressure resistance depends on the connection material)					
5. Body material						
A	anodised aluminium					
6. Metering range						
0140	1.4.. 140 l/min					●
0350	3.5.. 350 l/min					●
0550	○ 5.5.. 550 l/min					●
0800	8.0.. 800 l/min					●
1000	○ 10.0..1000 l/min					●
1500	15.0..1500 l/min					●
2500	25.0..2500 l/min					●
7. Seal material						
N	NBR					
V	○ FKM					
8. Connection for						
E	electronics					
9. For nominal width						
025	DN 25 - G 1					●
032	DN 32 - G 1 1/4					●
040	DN 40 - G 1 1/2					●
050	DN 50 - G 2					●
065	DN 65 - G 2 1/2					●

10. Analog output		
I	current output 0/4..20 mA	●
U	○ voltage output 0/2..10 V	●
K	without	●
11. Electrical connection		
S	for round plug connector M12x1, 5-pole	
12. Option 1		
H	○ model with gooseneck	
O	○ tropical model ○ oil-filled version for heavy duty or external use	
13. Option 2		
C	○ Counter C	
C1	○ Counter C1	

Further options available on request.

Options

Counter C (hardware and software option):
 Preset Counter with external reset option, complementary switching outputs and actual value display (modified wiring diagram!)

Counter C1 (software option):
 Instantaneous value display with analogue output, pulse-volume output and totalizer

Accessories

- Cable/round plug connector (KB...) see additional information "Accessories"
- Device configurator ECI-1

Accessories

- External display / converter OMNI-TA (panel-mounting IP 67)
- External display / converter OMNI-REMOTE (panel-mounting IP 67)

... professional Instruments "MADE IN GERMANY"