

Product Information

Flow Transmitter / Switch Screw Volumeter FLEX-VHS



- Measures and monitors viscous media (oil) 1.4..2500 l/min
- Connection G 1..G 2¹/₂
- Very low dependence on viscosity
- Can be used up to 40,000 mm²/s (cSt)
- Switching output and analog output (4..20 mA / 0..10 V)
- Light and compact device (aluminium housing)
- Operation and measurement possible with forwards and reverse flow
- For cost-sensitive applications
- Simple to use
- Cable outlet infinitely rotatable

Characteristics

The VHS flow transmitter measures the flow using the volumetric principle, and is suitable for fluid, viscous, lubricant media (e.g. lubricating oil). If the material for the VHS is selected appropriately, aqueous fluids such as soaps, pastes, and emulsions with non-abrasive characteristics can also be measured, as long as they have sufficient lubricity. Because of the volumetric functioning principle, the device is almost completely independent of viscosity.

The VHS system consists of two interlacing screws which run in opposite directions, driven by the flowing medium. A magnetically pre-tensioned Hall sensor positioned outside the flow space detects the screw flanks, and creates a frequency signal proportional to the flow. Here, every pulse corresponds to a specific measured volume. There are no magnets in the flow space.

The FLEX transducer on the sensor has an analog output (4..20 mA or 0..10 V) and one switching output, which can be configured as a limit switch for monitoring minimal or maximal, or as a frequency output or pulse output.

The switching output is designed as a push-pull driver, and can therefore be used both as a PNP or an NPN output. The state of the switching output is signalled with a yellow LED in the switching outlet; the LED has all-round visibility.

The sensor is configured in the factory, or alternatively this can be done with the aid of the optionally available ECI-1 device configurator (USB interface for PC). A selectable parameter can be modified on the device, with the aid of the magnet clip provided. In this case, the current measured value is saved as the parameter value. Examples of these parameters are the switching value or the metering range end value. The stainless steel electronics housing is rotatable, so it is possible to orient the cable outlet after installation.

Technical data

Sensor	screw volumeter		
Nominal width	DN 25..65		
Process connection	female thread G 1..G 2 ¹ / ₂		
Metering ranges	see table "Ranges and weights"		
Measurement accuracy	±1 % of the measured value (at 20 mm ² /s, (cSt) of 1 %..100 % nominal working range (see also diagram in upstream pages)		
Repeatability	±0,25 %		
Pressure resistance	Connection	SAE flange	PN bar
	aluminium	without	160
	aluminium	with	350
	steel	without	350
	steel	with	350
	others available on request		
Pressure loss	see diagram in upstream pages		
Medium	oil or non-aggressive self-lubricating fluids		
Medium temperature	-25..+80 °C (150 °C available on request)		
Materials medium-contact	(special materials available on request):		
1. Body	Aluminium 6082 anodised		
2. Connections:	Aluminium 6082 anodised or steel		
3. Main screw	Steel 35SMnPb10 UNI 4838-80		
4. Subsidiary screw	GHISA GJL-250 EN1561		
5. Ball bearing	Steel		
6. Ball bearing	Steel		
7. screws	Galvanised steel		
8. O-ring	NBR		
9. Seeger ring	Steel		
10. Seeger ring	Steel		
11. O-ring	NBR		
12. SAE connection	ASTM A216WCB		
13. SAE flange	ASTM A216WCB		
14. O-ring	NBR		
15. screws	Galvanised steel		
16. Sensor spacer	Aluminium 6082 anodised		
Material electronics housing	stainless steel 1.4305		
Supply voltage	18..30 V DC		
Power consumption	<1 W		

... professional Instruments "MADE IN GERMANY"

Product Information

Analog output	4..20 mA / load 500 Ohm max. or 0..10 V / load min. 1 kOhm
Switching output	transistor output "push-pull" (resistant to short circuits and polarity reversal) $I_{out} = 100$ mA max.
Switching hysteresis	adjustable (please state when ordering) Standard setting: 2 % F.S., for Min-switch, position of the hysteresis above the limit value, and for Max-switch, below the limit value
Pulse output	pulse width 50 ms → max. output frequency < 20 Hz
Display	yellow LED (On = Normal / Off = Alarm)
Electrical connection	for round plug connector M12x1, 4-pole
Ingress protection	IP 67
Weight	see table "Ranges and weights"
Conformity	CE

Ranges and weights

● = Standard ○ = Option

G	DN	●	Metering range 1..100 % Q_{nom} l/min	Volume / pulse cm ³	Types	Q_{max} recommended l/min	weights		
							Body with aluminium connections kg	Body with steel connections kg	SAE Flanges (Weight per pair) kg
G 1	DN 25	●	1.4.. 140	13.10	FLEX-VHS-025.....0140	200	3.44	4.76	5.76
G 1/4	DN 32	●	3.5.. 350	29.00	FLEX-VHS-032.....0350	500	6.35	8.50	9.55
G 1 1/2	DN 40	○	5.5.. 550	48.58	FLEX-VHS-040.....0550	800	10.50	13.60	15.10
		●	8.0.. 800	72.00	FLEX-VHS-040.....0800	1200	14.20	18.50	18.80
G 2	DN 50	●	10.0..1000	103.63	FLEX-VHS-050.....1000	1600	20.70	27.70	30.30
		●	15.0..1500	133.00	FLEX-VHS-050.....1500	2200	25.00	33.20	34.60
G 2 1/2	DN 65	●	25.0..2500	238.82	FLEX-VHS-065.....2500	3800	42.70	56.10	60.70

Wiring

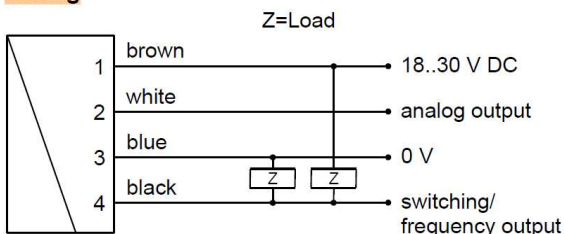

Connection example: PNP NPN

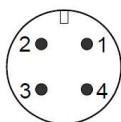

Before the electrical installation, it must be ensured that the supply voltage corresponds with the data sheet.
The use of shielded cabling is recommended.

... professional Instruments "MADE IN GERMANY"

Product Information

Dimensions

● = Standard ○ = Option

							VHS-...GAO....				VHS-...GAX....			
G	DN...ranges	x1	L1	ØD	SW	A	M	x2	B	C	L2	H	E	F
G 1	025...0140	●	20	220	88	78	12	20	57.1	27.8	324	52	80	69
G 1 ^{1/4}	032...0350	●	22	285	103	-	14	22	66.7	31.6	381	48	94	77
G 1 ^{1/2}	040...0550	○	24	332	122	-	16	24	79.4	36.5	448	58	106	89
	040...0800	●		340	138	-					456			
G 2	050...1000	○	33	396	155	-	20	35	96.8	44.4	544	74	135	116
	050...1500	●		405	168	-					553			
G 2 ^{1/2}	065...2500	●	35	475	203	-	24	42	123.8	58.7	633	79	166	150

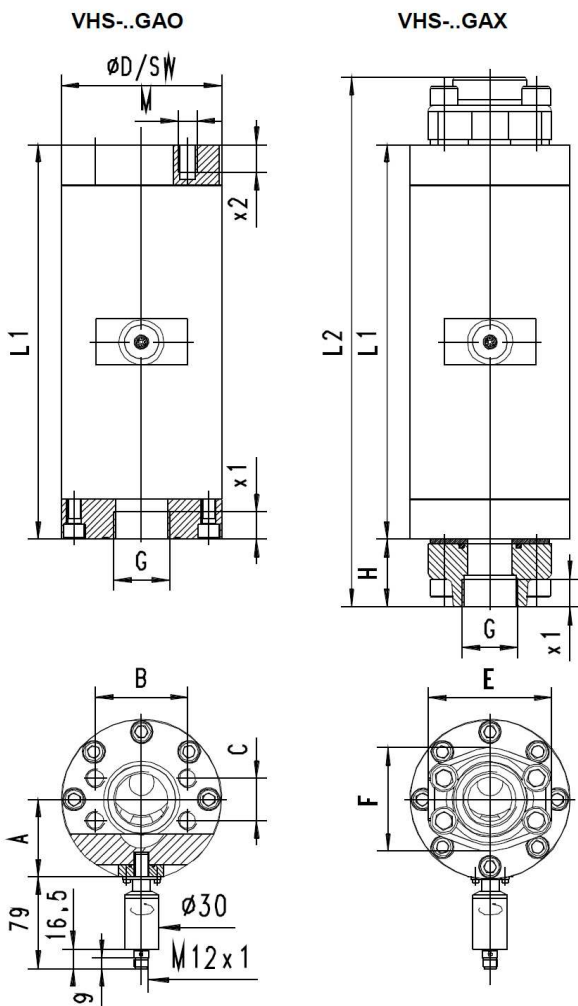

SAE adapter for convenient installation and for increased stability to pressure! (350 bar)

Handling and operation

Installation

Any flow direction is possible during installation. Ensure that pipework is clean. Flush before installation. A 30 µm mesh filter should be used. The use of SAE flanges enables the sensor to be installed and removed more easily, and increases the stability to pressure to 350 bar for every connection material.

It is possible to replace the electronics during operation, and this presents no danger to the fitter. The sensor does not go into the flow space. After installation, the electronic head can be turned to align the cable outlet.

... professional Instruments "MADE IN GERMANY"

Product Information

Programming

The electronics contain a magnetic contact, with the aid of which different parameters can be programmed. Programming takes place when a magnet clip is applied for a period between 0.5 and 2 seconds to the marking located on the label. If the contact time is longer or shorter than this, no programming takes place (protection against external magnetic fields).



After the programming ("teaching"), the clip can either be left on the device, or removed to protect data.

The device has a yellow LED which flashes during the programming pulse. During operation, the LED serves as a status display for the switching output.

In order to avoid the need to transit to an undesired operating status during "teaching", the device can be provided ex-works with a "teach-offset". The "teach-offset" value is added to the currently measured value before saving (or is subtracted if a negative value is entered).

Example: The switching value is to be set to 70 % of the metering range, because at this flow rate a critical process status is to be notified. However, only 50 % can be achieved without danger. In this case, the device would be ordered with a "teach-offset" of +20 %. At 50 % in the process, a switching value of 70 % would then be stored during "teaching".

Normally, programming is used to set the limit switch. However, if desired, other parameters such as the end value of the analog or frequency output may also be set.

The limit switch can be used to monitor minimal or maximal.

With a minimum-switch, falling below the limit value causes a switchover to the alarm state. Return to the normal state occurs when the limit value plus the set hysteresis is again exceeded.

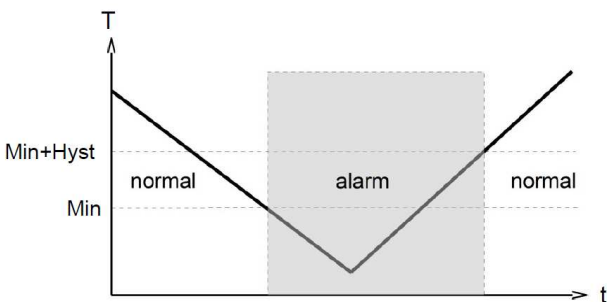

With a maximum-switch, exceeding the limit value causes a switchover to the alarm state. Return to the normal state occurs when the measured value once more falls below the limit value minus the set hysteresis.

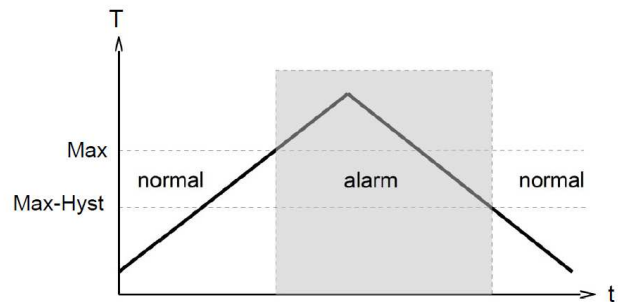

A switchover delay time (t_{DS}) can be applied to the switchover to the alarm state. Equally, one switch-back delay time (t_{DR}) of several can be applied to switching back to the normal state.

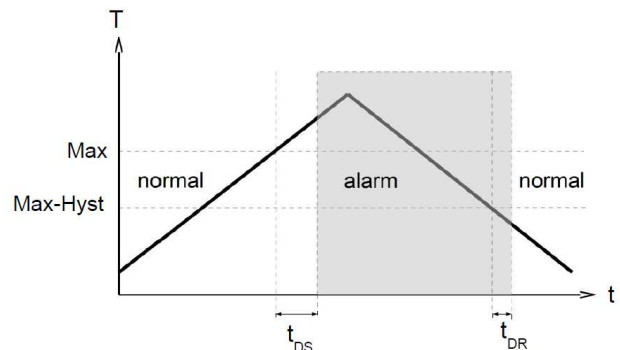

In the normal state the integrated LED is on, in the alarm state it is off, and this corresponds to its status when there is no supply voltage.

In the non-inverted (standard) model, while in the normal state the switching output is at the level of the supply voltage; in the alarm state it is at 0 V, so that a wire break would also display as an alarm state at the signal receiver. Optionally, an inverted switching output can also be provided, i.e. in the normal state the output is at 0 V, and in the alarm state it is at the level of the supply voltage.

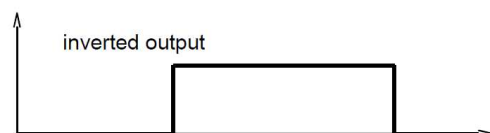
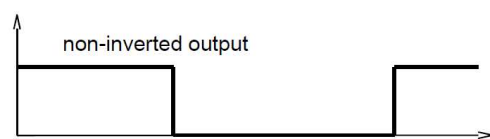

A Power-On delay function (ordered as a separate option) makes it possible to maintain the switching output in the normal state for a defined period after application of the supply voltage.

... professional Instruments "MADE IN GERMANY"

Product Information

Ordering code

VHS - 1. 2. 3. 4. 5. 6. 7. 8.

FLEX - VHS - 9. 10. 11. 12. 13.

○=Option

1. Nominal width									
025	DN 25 - G 1								
032	DN 32 - G 1 1/4								
040	DN 40 - G 1 1/2								
050	DN 50 - G 2								
065	DN 65 - G 2 1/2								
2. Process connection									
G	female thread								
3. Connection material									
A	AL connection, anodised (160 bar, in combination with SAE flange: 350 bar)								
S	○ Connection, steel (350 bar)								
4. Additional flange									
X	SAE flange, steel (350 bar)								
O	no SAE flange (pressure resistance depends on the connection material)								
5. Body material									
A	anodised aluminium								
6. Metering range									
0140	1.4.. 140 l/min								●
0350	3.5.. 350 l/min								●
0550	○ 5.5.. 550 l/min								●
0800	8.0.. 800 l/min								●
1000	○ 10.0..1000 l/min								●
1500	15.0..1500 l/min								●
2500	25.0..2500 l/min								●
7. Seal material									
N	NBR								
V	○ FKM								
8. Connection for									
E	electronics								
9. For nominal width									
025	DN 25 - G 1								●
032	DN 32 - G 1 1/4								●
040	DN 40 - G 1 1/2								●
050	DN 50 - G 2								●
065	DN 65 - G 2 1/2								●
10. Analog output									
I	current output 4..20 mA								
U	voltage output 0..10 V								
11. Switching function									
L	minimum-switch								
H	maximum-switch								
R	frequency output								
C	Pulse output								
12. Switching signal									
O	standard								
I	○ inverted								
13. Optional									
H	○ 150 °C version (with 300 mm cable)								

Required ordering information

For FLEX-VHS-C:

For the pulse output version, the volume (with numerical value and unit) which will correspond to one pulse must be stated.

Volume per pulse (numerical value)

Volume per pulse (unit)

Options

Special range for analog output: l/min

<= metering range (standard = metering range)

Special range for frequency output: l/min

<= metering range (standard = metering range)

End frequency (max. 2000 Hz) Hz

Switching delay s

(from Normal to Alarm)

Switchback delay s

(from Alarm to Normal)

Power-On delay period (0..99 s) s

(time after power on, during which the outputs are not actuated)

Switching output fixed l/min

Special hysteresis %

(standard = 2 % of end value)

If the fields are not completed, the standard setting is selected automatically.

Accessories

- Cable/round plug connector (KB...) see additional information "Accessories"
- Device configurator ECI-1

Supplement

External display OMNI-TA (panel-mounting IP 67)

... professional Instruments "MADE IN GERMANY"