

Flow transmitter /-switch OMNI-HR2VE



- Optimized for use with oil
- Analog output 4..20 mA or 0..10 V
- Two programmable switches
- Graphical LCD display, backlit, can be read in sunlight and in the dark
- Selectable units in the display
- Programmable parameters via rotatable, removable ring (programming protection)
- Electronics housing with non-scratch, chemically resistant glass
- Rotatable electronic housing for best reading position
- Designed for industrial use

Characteristics

Mechanical flow switch, for fluid media, with spring-supported piston and magnetic triggering of Hall sensors. Robust construction in brass or stainless steel.

The OMNI transducer located on the sensor has a backlit graphics LCD display which is very easy to read, both in the dark and in bright sunlight. The graphics display allows the presentation of measured values and parameters in a clearly understandable form. The measured values are displayed to 4 places, together with their physical unit, which may also be modified by the user. The electronics have an analog output (4..20 mA or 0..10 V) and two switching outputs, which can be used as limit switches for monitoring minimal or maximal, or as two-point controllers. The switching outputs are designed as push-pull drivers, and can therefore be used both as PNP and NPN outputs. Exceeding limit values is signaled by a red LED which is visible over a long distance, and by a clear text in the display.

The stainless steel housing has a hardened non-scratch mineral glass pane. It is operated by a programming ring fitted with a magnet, so there is no need to open the operating controls housing, and its leakproofness is permanently ensured.

By turning the ring to left or right, it is simple to modify the parameters (e.g. switching point, hysteresis...). To protect from unintended programming, it can be removed, turned through 180° and replaced, or completely removed, thus acting as a key.



OPTION C:

Preset Counter with external reset option, complementary switching outputs and actual value display.

OPTION C1:

Instantaneous value display with analogue output, pulse-volume output and totalizer.

Technical data

Sensor	analog Hall sensor	
Nominal width	DN 32 / 40 / 50	
Process connection	female thread G 1 1/4..G 2 (further process connections available on request)	
Metering range	10..160 l/min	for details see table "Ranges"
Pressure loss	~ 4..7 bar at Q _{max}	
Q _{max}	up to 160 l/min	
Measurement accuracy	±5 % of full scale value at constant viscosity	
Viscosity-stability	±10 % of full scale value (20-330 mm ² /s)	
Pressure resistance	PS 200 bar	
Medium temperature	-20..+85 °C, optionally -20..+100 °C	
Ambient temperature	-20..+70 °C	
Media	oil	
Wiring	see section "Wiring"	
Materials medium-contact	Brass construction: CW614N nickelled, CW614N, 1.4305, 1.4310, hard ferrite,	Stainless steel construction: 1.4571, 1.4310, hard ferrite
Materials, non-medium-contact	Electronic adapter Electronics housing Glass Magnet Ring	CW614N nickelled Stainless steel 1.4305 Mineral glass, hardened Samarium-Cobalt POM
Supply voltage	18..30 V DC	
Power consumption	<1 W	
Analog output	4..20 mA / max. load 500 Ω or 0..10 V / min. load 1 kΩ	
Switching output	Transistor output "Push-Pull" (resistant to short circuits and polarity reversal) I _{out} = 100 mA max.	
Hysteresis	adjustable, position of the hysteresis depends on minimum or maximum	
Display	extendable graphic LCD display Temperature range -20..+70 °C, 32 x 16 pixels, background illumination, displays value and unit, flashing LED signal lamp with simultaneous message on the display	
Electrical connection	for round plug connector M12x1, 5-pole	
Ingress protection	IP 67 (IP 68 when oil-filled)	
Weight	see table "Dimensions and weights"	
Conformity	CE	

Product Information

Installation location	Standard: horizontal inwards flow; other installation positions are possible; the installation position affects the display, metering and switching range.
------------------------------	--

Signal output curves

Value x = begin of the specified range
 = not specified range

Current output

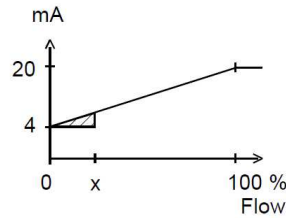

Voltage output

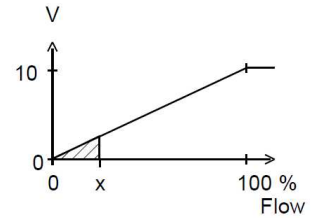

Other characteristics on request.

Ranges

Details in the table correspond to metering ranges with horizontal inwards flow and increasing flow rate.

Standard type OMNI-HR2VE

Metering range l/min oil 20-330 mm ² /s	Q _{max.} Recommended l/min	Pressure loss bar at Q _{max.} oil
10 - 80	100	4
20 - 120	120	5
30 - 140	140	5
50 - 160	160	7

Special ranges are available.

Reference Data:

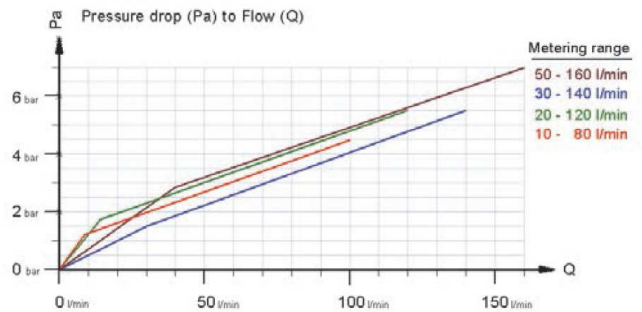

Metering spaces of the flow switch HR2VK1

Product Information

Sensors and Instrumentation

Wiring

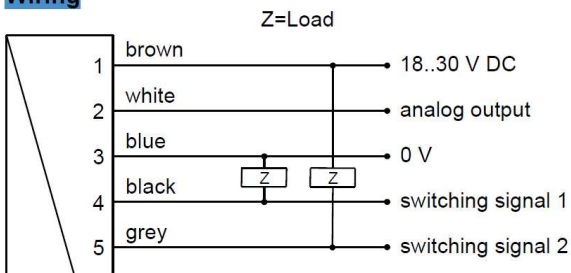

Connection example: PNP NPN

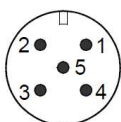

See separate wiring at C and C1 option in the separate descriptions.

Before the electrical installation, it must be ensured that the supply voltage corresponds to the data sheet.

It is recommended to use shielded wiring.

The Push-Pull output) can as desired be switched as a PNP or an NPN output.

Dimensions and weights

..including OMNI-electronics

DN	G	Types	L	ØD	SW	Ød	X	Weight kg
32	G 1 1/4	HR2VE-032GM	130	65	60	51	23	2.8
40	G 1 1/2	HR2VE-040GM	170	65	60	56	24	3.3
50	G 2	HR2VE-050GM	185	80	75	70	26	5.5

High temperature

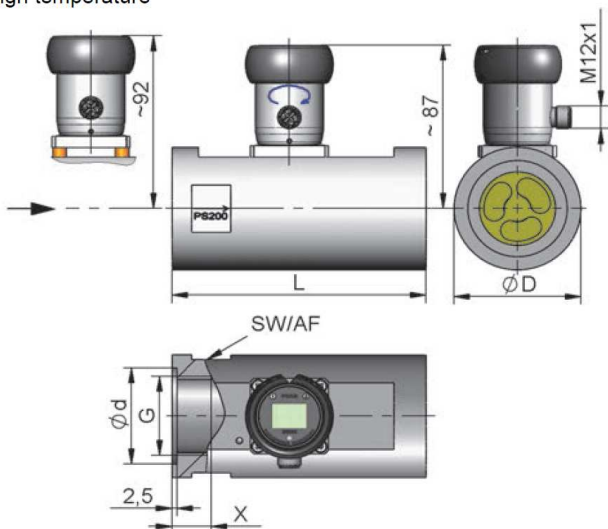

Gooseneck option



A gooseneck (optional) between the electronics head and the primary sensor provides freedom in the orientation of the sensor. This option simultaneously provides thermal decoupling between the two units

Handling and operation

Note

- Include straight calming section of 5 x DN in inlet and outlet
- If the media are dirty, install a filter (use magnetic filter for ferritic components)
- Under unfavorable pressure conditions, e.g. with a free outlet, there is a risk of cavitation.

The electronics housing is permanently connected to the primary sensor. There is no electrical connection between the electronics and the piston device. After installation, the electronic head can be turned to align the cable outlet.

It should be ensured that the piston device and the OMNI electronics are appropriately matched to each other.

Programming

The annular gap of the programming ring can be turned to positions 1 and 2. The following actions are possible:



Set to 1 = continue (STEP)
 Set to 2 = modify (PROG)

Neutral position between 1 and 2

The ring can be removed to act as a key, or turned through 180° and replaced to create a programming protector. Operation is by dialog with the display messages, which makes its use very simple.

Starting from the normal display (present value and unit), if 1 (STEP) is repeatedly selected, then the display shows the following information in this order:

Display of the parameters, using position 1

- Switching value S1 (switching point 1 in the selected unit)
- Switching characteristic of S1
 MIN = Monitoring of minimum value
 MAX = Monitoring of maximum value
- Hysteresis 1 (hysteresis value of S1 in the set unit)
- Switching value S2
- Switching characteristic of S2
- Hysteresis 2
- Code
 After entering the code 111, further parameters can be defined:
- Filter (settling time of the display and output)
- Physical unit (Units)
- Output: 0..20 mA or 4..20 mA
- 0/4 mA (measured value corresponding to 0/4 mA)
- 20 mA (measured value corresponding to 20 mA)

For models with a voltage output, replace 20 mA accordingly with 10 V.

Product Information

Edit, using position 2

If the currently visible parameter is to be modified:

- Turn the annular gap to position 2, so that a flashing cursor appears which displays the position which can be modified.
- By repeatedly turning to position 2, values are increased; by turning to position 1, the cursor moves to the next digit.
- Leave the parameter by turning to position 1 (until the cursor leaves the row); this accepts the modification.
- If there is no action within 30 seconds, the device returns to the normal display range without accepting the modification.

The limit switches S1 and S2 can be used to monitor minimal or maximal.

With a minimum-switch, falling below the limit value causes a switchover to the alarm state. Return to the normal state occurs when the limit value plus the set hysteresis is once more exceeded.

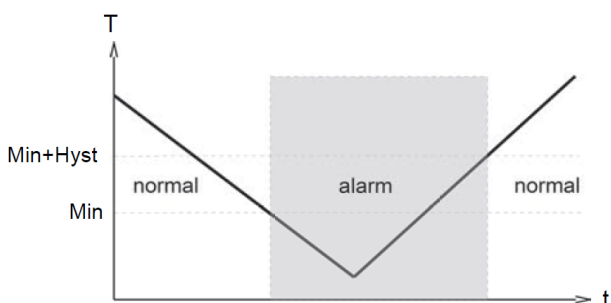

With a maximum-switch, exceeding the limit value causes a switchover to the alarm state. Return to the normal state occurs when the measured value once more falls below the limit value minus the set hysteresis.

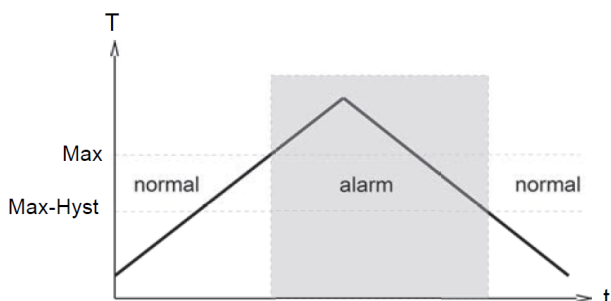

The change to the alarm state is indicated by the integrated red LED and a clear text in the display.

While in the normal state, the switching outputs are at the level of the supply voltage; in the alarm state they are at 0 V, so that a wire break would also display as an alarm state at the signal receiver.

Overload display

Overload of a switching output is detected and indicated on the display ("Check S1 / S2"), and the switching output is switched off.

Simulation mode

To simplify commissioning, the sensor provides a simulation mode for the analog output. It is possible to create a programmable value in the range 0..26.0 mA at the output (without modifying the process variable). This allows the wiring run between the sensor and the downstream electronics to be tested during commissioning. This mode is accessed by means of code 311.

Factory settings

After modifying the configuration parameters, it is possible to reset them to the factory settings at any time using Code 989.

Ordering code

The basic device is ordered e.g. HR2VE-032GM100 with electronics e.g. OMNI-HR2VE-ISO

HR2VE - 1. 2. 3. 4. G

OMNI - HR2VE - 5. 6. 7. S

○=Option

1. Nominal width		
032	DN 32 - G 1 ¹ / ₄	
040	DN 40 - G 1 ¹ / ₂	
050	DN 50 - G 2	
2. Process connection		
G	female thread	
3. Connection material		
M	brass	
K	stainless steel	
4. HR2VE - Metering range H₂O for horizontal inwards flow		
080	10.. 80 l/min	
120	20..120 l/min	
140	30..140 l/min	
160	50..160 l/min	
5. Analog output		
I	current output 0/4..20 mA	•
U	voltage output 0/2..10 V	•
K	without	•
6. Electrical connection		
S	for round plug connector M12x1, 5-pole	
7. Option 1		
D	high temperature up to 120°C	
H	model with gooseneck	
O	tropical model - oil-filled version for heavy duty or external use	
8. Option 2		
C	counter C	
C1	counter C1	

Options

- Special quantities

Ordering information

- Specify direction of flow, medium, and metering range.

Accessories

- Cable/round plug connector (KB...) see additional information "Accessories"
- Device configurator ECI-1