

ENGINEERING
YOUR SPRAY SOLUTION



PRECISION SPRAY NOZZLES AND ACCESSORIES

for industrial spray solutions | Edition 221

INDUSTRY

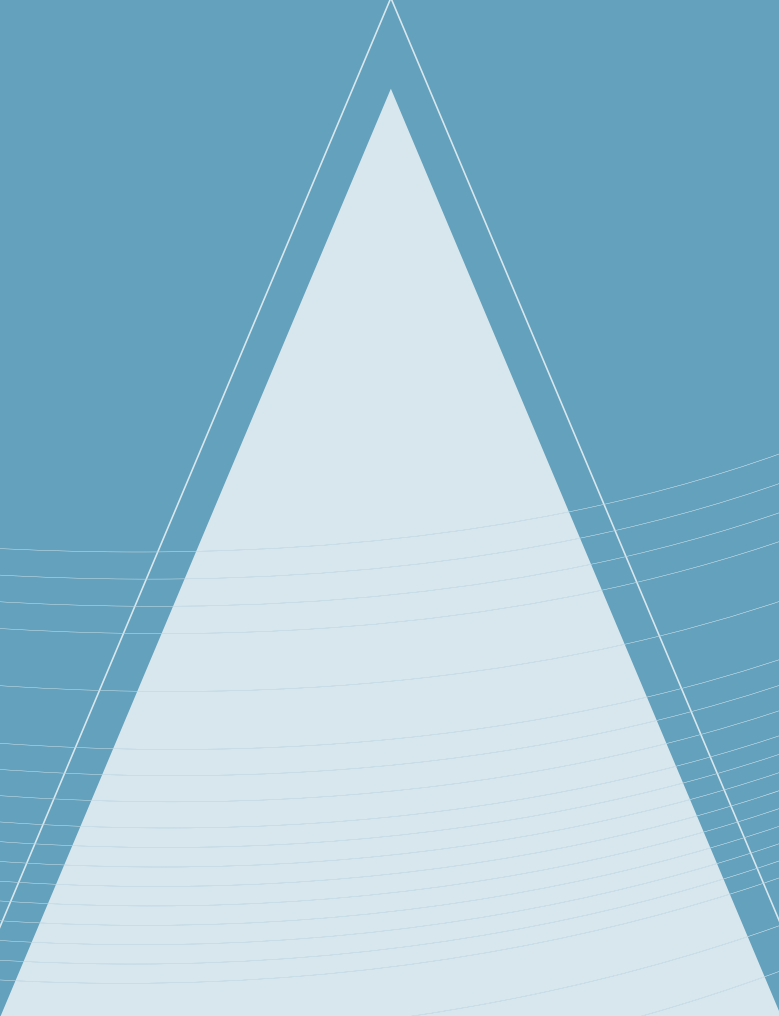
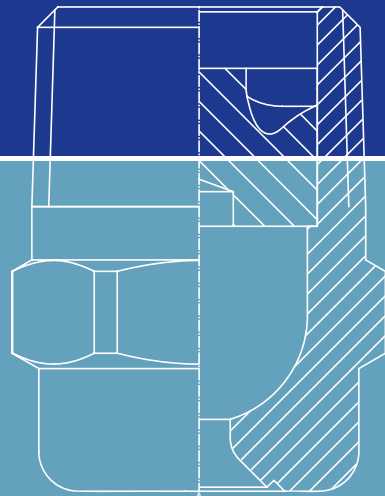



INDUSTRIAL NOZZLE TECHNOLOGY FROM EUROPE'S LEADING SUPPLIER

CONTENTS

	Introduction	4
	Pneumatic atomizing nozzles	24
	Hollow cone nozzles	60
	Full cone nozzles	78
	Flat fan nozzles	100
	Solid stream nozzles	150
	Compressed air nozzles	158
	Tank cleaning nozzles	180
	Nozzle-valve combinations	218
	Accessories	228
	Planning aids	254





➤➤ WHERE TRADITION
MEETS THE FUTURE



1879

Company founded by
Paul Lechler

1893

Patent for
liquid atomization

1967

Relocation of production
to Metzingen

1978

Expansion to the USA
and then to
other countries

1995

Production, sales
and administration are
concentrated in Metzingen



140

1879 - 2019

2010

Expansion of production with a new 13.000 m² Manufacturing Plant

2016

New Development and Technology Center is opened in Metzingen

2019

Celebrating 140 years

2021

State of the art factories are built in India and China

2022

New logistics center in Metzingen



THERE ARE MANY REASONS TO CHOOSE NOZZLES FROM LECHLER

The first choice for your nozzle solution

You only become a market leader and Europe's number one in nozzle technology when you can offer your customers a variety of engineered spray solutions. Lechler embodies our relationships with customers on every level.

Unrivalled product diversity

Boasting over 45,000 different nozzles and nozzle systems, Lechler is able to solve the challenges of virtually every process in every industry. If there is not a product for you in our portfolio, Lechler will develop solutions working with our customers and their requirements.

Over 140 years of experience

Lechler has been atomizing liquids since 1879. Today, we understand spray technology better than anyone else. With this experience, we not only develop the perfect nozzle for each application, but also offer expert advice on optimising spraying processes.

State of the Art Manufacturing

Whether you are looking for state-of-the-art metal processing, precision injection moulding, metal injection molding (MIM), ceramic sintering or 3D printing: We have the experience and knowledge to offer all manufacturing techniques.

Measurement Technology Center

In our globally incomparable development and technology center, we analyze the spray behavior of our nozzles. Equipped with cutting-edge test rigs, highly developed nozzle measurement technology and state of the art infrastructure. Lechler's research and development center offers various opportunities that serve all of our customers needs; from practical testing, droplet analysis, measurement technology, and more.

Highly qualified employees

Employee management at Lechler is characterized by the promotion of continuous development and team spirit in the workplace. This is the secret recipe behind our companies success and true passion and commitment of our people throughout the organization.

Creating Solutions

The needs and requirements of our customers are at the forefront of everything we do. Our goal is to always offer the ideal solution for every task, and if it is not yet available, we develop it.

Long Lasting Customer Relationships

Longevity and quality is the foundation to which our business is built upon. We thrive on mutual trust and attach great importance to excelling through performance, know-how and long-term partnerships.

XactClean HP
High Performance





GERMAN ENGINEERING EUROPE'S NO. 1 GLOBAL MARKET LEADER

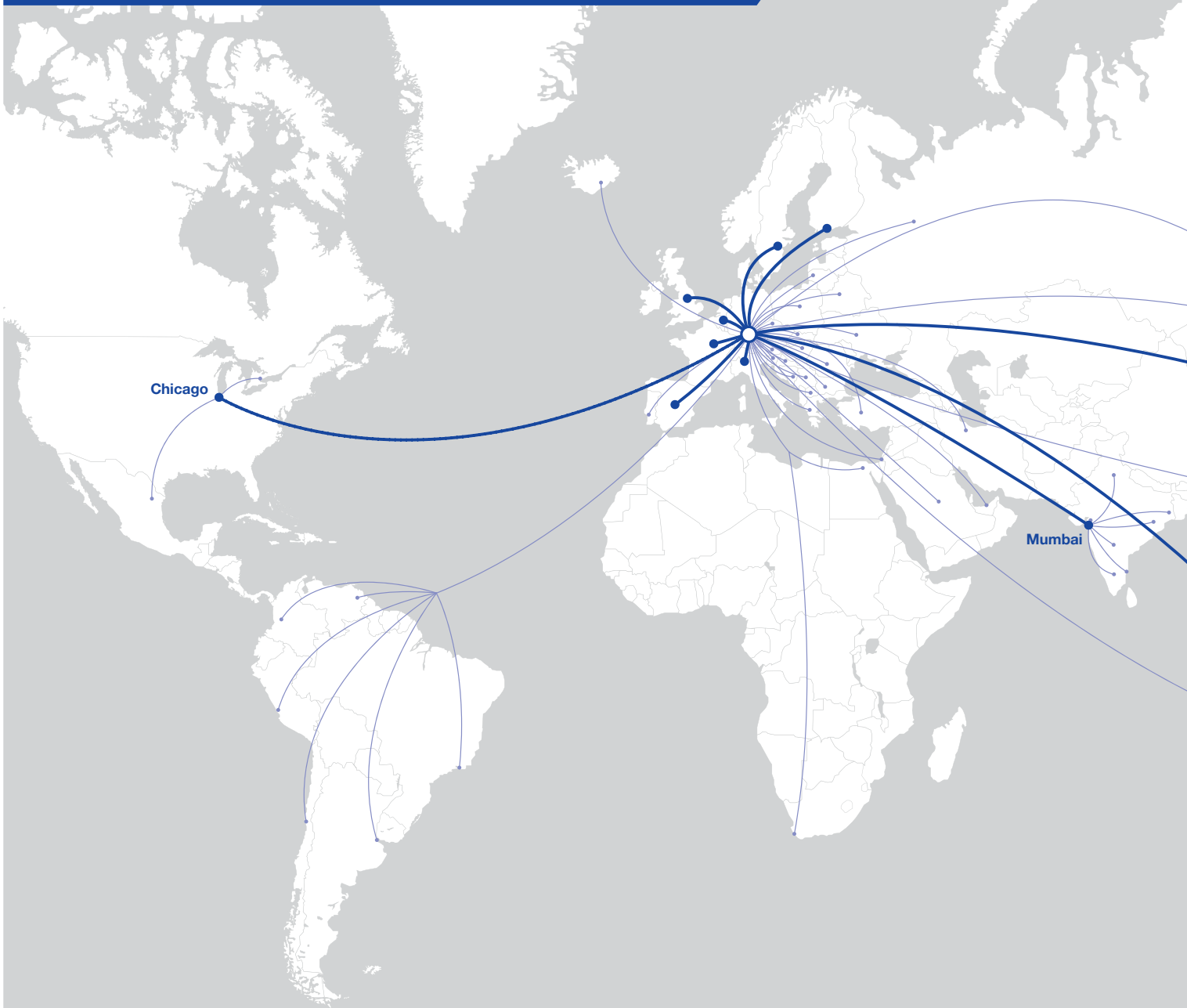

Headquarters



Subsidiaries



Sales office/
Sales agent

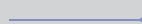

 **Headquarters**
 **Production**
 **Sales**
**Germany**

Lechler GmbH
Ulmer Straße 128
D - 72555 Metzingen
Phone +49 7123 962-0
ind@lechler.de

**United Kingdom**

Lechler Ltd.
1 Fell Street, Newhall
Sheffield, S9 2TP
Phone +44 114 2492020
info@lechler.com

**USA**

Lechler Inc.
445 Kautz Road
St. Charles, IL 60174
Phone +1 630 3776611
info@lechlerusa.com

**Belgium**

Lechler S.A./N.V.
Avenue Newton 4
1300 Wavre
Phone +32 10 225022
info@lechler.be

**France**

Lechler France SAS
Bât. CAP2
66-72 Rue Marceau
93100 Montreuil
Phone +33 1 49882600
info@lechler.fr

**Sweden**

Lechler AB
Kungsängsvägen 31B
753 23 Uppsala
Phone +46 18 167030
info@lechler.se

**China**

Lechler (Tianjin) Intl. Trad. Co. Ltd.
Rm. 418 Landmark Tower
No. 8 Dong San Huan Bei Lu
Beijing, 100004
Phone +86 10 84537968
info@lechler.com.cn

**India**

Lechler (India) Pvt. Ltd.
Plot B-2
Main Road
Wagle Industrial Estate Thane
400604 Maharashtra
Phone +91 22 40634444
lechler@lechlerindia.com

**ASEAN**

Lechler Spray Technology Sdn.
Bhd.
No. 23 Jalan, Teknologi 3/3A
Taman Sains Selangor 1
Kota Damansara, PJU 5
47810 Petaling Jaya, Malaysia
Phone +603 6142 1288
info@lechler.com.my

**Finland**

Lechler Oy
Ansatie 6 a C 3 krs
01740 Vantaa
Phone +358 207 856880
info@lechler.fi

**Italy**

Lechler Spray Technology S.r.l.
Via Don Dossetti, 2
20080 Carpiano (Mi)
Phone +39 2 98859027
info@lechleritalia.com

**Spain**

Lechler, S.A.
Avda. Pirineos, 7,
Edificio Inbisa I, Oficina B7
28703 San Sebastián de los
Reyes (Madrid)
Phone +34 91 6586346
info@lechler.es

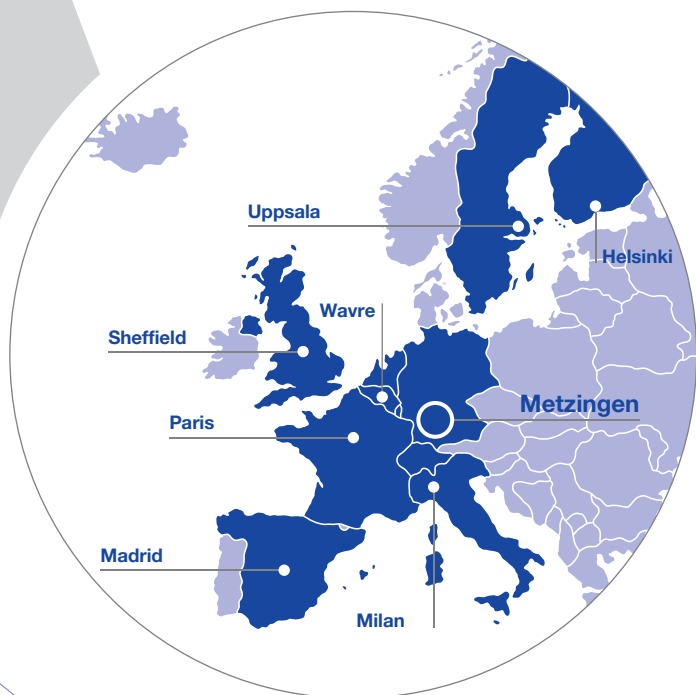

- Subsidiaries
- Sales office/
Sales agent

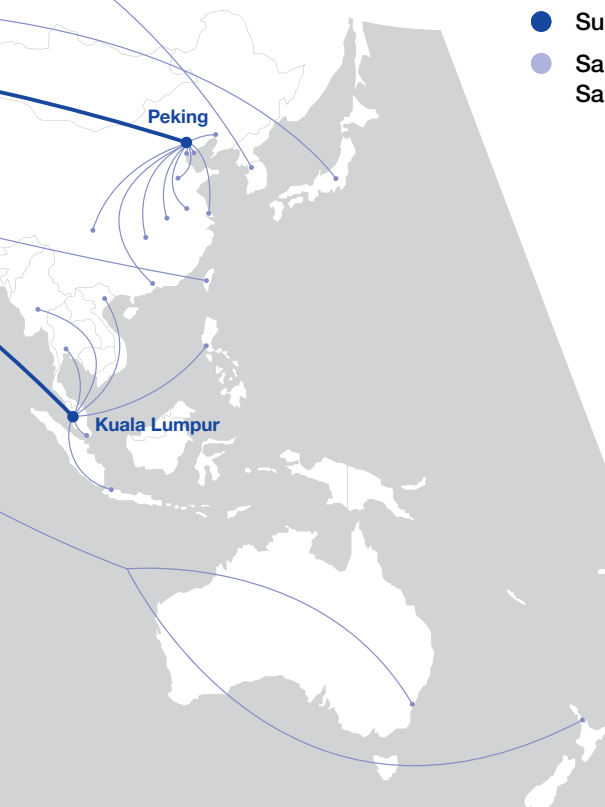

DIVERSITY IN TOP FORM

Lechler's services go far beyond the development and production of nozzles. Thanks to an extensive portfolio of products and services, we are able to ensure optimum spraying results in a wide range of industries and applications.

MEASURING TECHNOLOGY

At Lechler, high-precision spray measurements and analysis are not only used for nozzle developments, they are also offered as a service.



For detailed information about our range of services, please visit:
www.lechler.com

NOZZLES

In addition to the nozzles presented in this catalogue, our portfolio also includes numerous special nozzles – for applications in many other industries, from agriculture to steel production.

CFD

Computational Fluid Dynamics (CFD) not only enables us to develop nozzles quickly and precisely, it also ensures customer-specific process optimization.

ENGINEERING

Our experienced engineering team strives to provide you with a system solution tailored to your application and installation-specific conditions.



DROPLET SEPARATORS

Our droplet separators play a key role in process optimizations. They are primarily designed to separate liquids from gas flows and are currently used in over 100 different applications worldwide.

LANCES AND CUSTOM SOLUTIONS

With custom nozzle lances, spray headers and spray systems, we ensure the implementation of customized solutions for your specific application.



FOUR BUSINESS DIVISIONS DIVERSITY AT ITS FINEST

There's more to spraying than meets the eye. Various industries have their own focus and requirements. To meet all of them, we develop and sell industry-oriented solutions in four individual business sectors.

Our diversity and experience spanning over 140 years gives us a wealth of knowledge that is shared to guarantee the best engineered spray solution across all industries.



GENERAL INDUSTRY

Food and Beverage Industry, Pharmaceutical Industry, Chemical Industry, Automotive Industry, just to name a few. Lechler Nozzles can be found in almost every production environment. With a deep understanding of customer processes, we ensure an optimized engineered spray solution for every application.



AGRICULTURE

From plant protection and liquid fertilization to irrigation – Lechler offers the ideal nozzles for precise application, thereby achieving the best results with minimal effort in the shortest possible time. This helps to increase yields and protect the environment.



METALLURGY

Steel and aluminium producers face immense competitive pressure worldwide. The required product qualities can only be produced with maximum energy efficiency through optimization of your process. Lechler nozzles make a decisive contribution to producing innovative material grades and reducing CO₂ emissions.



AIR QUALITY CONTROL SYSTEMS

Increasingly stringent emission requirements but also a growing number of voluntary commitments mean air quality control systems are in the spotlight more than ever. With its wide range of nozzles and efficient gas treatment systems, Lechler offers the perfect answer for every application.

➤➤ AT HOME IN MANY INDUSTRY SECTORS

We understand your processes and engineer every solution to match each nozzle to the respective environmental conditions. Our specialists will help you choose the right nozzle and aid in engineering services to meet your application needs.

APPLICATIONS



CLEANING
REMOVING
COOLING
SURFACE TREATMENT
SURFACE SPRAYING
ATOMIZING
MIXING

AUTOMOTIVE INDUSTRY



CHEMICAL INDUSTRY



ELECTRONICS INDUSTRY





**INDUSTRIAL
CLEANING TECHNOLOGY**



**FOOD AND
BEVERAGE INDUSTRY**



SURFACE TREATMENT



**PHARMACEUTICAL AND
COSMETICS INDUSTRY**



**SHIPBUILDING INDUSTRY
AND MANY MORE ...**

➤➤ A BRIEF INTRODUCTION
TO MORE THAN
45,000 PRODUCTS

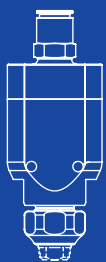
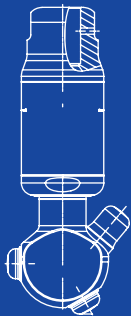
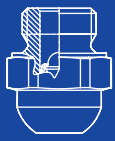



QUESTION OF SHAPE: THE IDEAL SPRAY PATTERN FOR YOUR APPLICATION

Form follows function – and vice-versa. The search for the right nozzle begins with the choice of atomization type (single fluid nozzle or pneumatic atomizing nozzle) and the appropriate spray pattern. This determines the essential properties of the nozzle.

Single fluid nozzle

By narrowing the cross section in the nozzle, the flow velocity of the fluid being atomized increases. Potential energy is converted into kinetic energy (speed). The fluid exiting the nozzle orifice discharges the liquid into droplets of various sizes and distribution.

Solid stream nozzles



Precise, solid jet with the highest impact and limited atomization.

Main applications:

- Cleaning
- Injection
- Targeted cooling

Flat fan nozzles



Defined spray, linear impact. A wide range of nozzles with various flow rates, spray angles and materials.

Main applications:

- Cleaning
- Coating
- Humidification

Hollow cone nozzles



Ring-shaped impact, various flow rates and fine atomization. Available in two designs (axial and tangential).

Main applications:

- Cooling
- Humidification
- Chemical engineering

Full cone nozzles



A wide range of nozzles with full surface impact. Available in two designs (axial and tangential).

Main applications:

- Cleaning
- Surface spraying
- Chemical engineering

Pneumatic atomizing nozzles

With pneumatic atomization, the various flow velocities of gases and liquids in a nozzle result in the desired shearing of the liquid into extremely fine droplets.



Finest atomization even of viscous fluids. Full cone or flat fan versions are available.

Main applications:

- Cooling
- Humidification
- Chemical engineering

Compressed air nozzles

Compressed air nozzles are used for dispersing air or saturated steam in a concentrated fan. Generally, they are flat fan, solid stream or round jet nozzles. Our multi-channel compressed air nozzles are extremely quiet and also economical in terms of air consumption.



High blowing force with maximum efficiency and reduced noise level.

Main applications:

- Blowing off and out
- Cooling
- Drying

Tank cleaning nozzles

For years now, our tank cleaning nozzles have been making a name for themselves as both an economical and highly effective solution for tank and equipment cleaning. The portfolio is divided into static spray balls and rotating cleaning nozzles.

Static nozzles



Extremely robust version for easy rinsing even at high temperatures.

Rotating nozzles



High cleaning performance in the low pressure range for any amount of soiling. Enables cleaning in place and saves on expensive cleaning chemicals.



OVERVIEW OF KEY NOZZLE PARAMETERS



FLOW RATE

TEMPERATURE

LIQUID

PRESSURE



In addition to the spray pattern, each nozzle has specific properties, which in turn depend on various – mutually influencing – operating parameters. An overview of the key factors can be found in the planning aids section starting on Page 258.

IMPACT

SPRAY ANGLE

DROPLET SIZE

LIQUID DISTRIBUTION

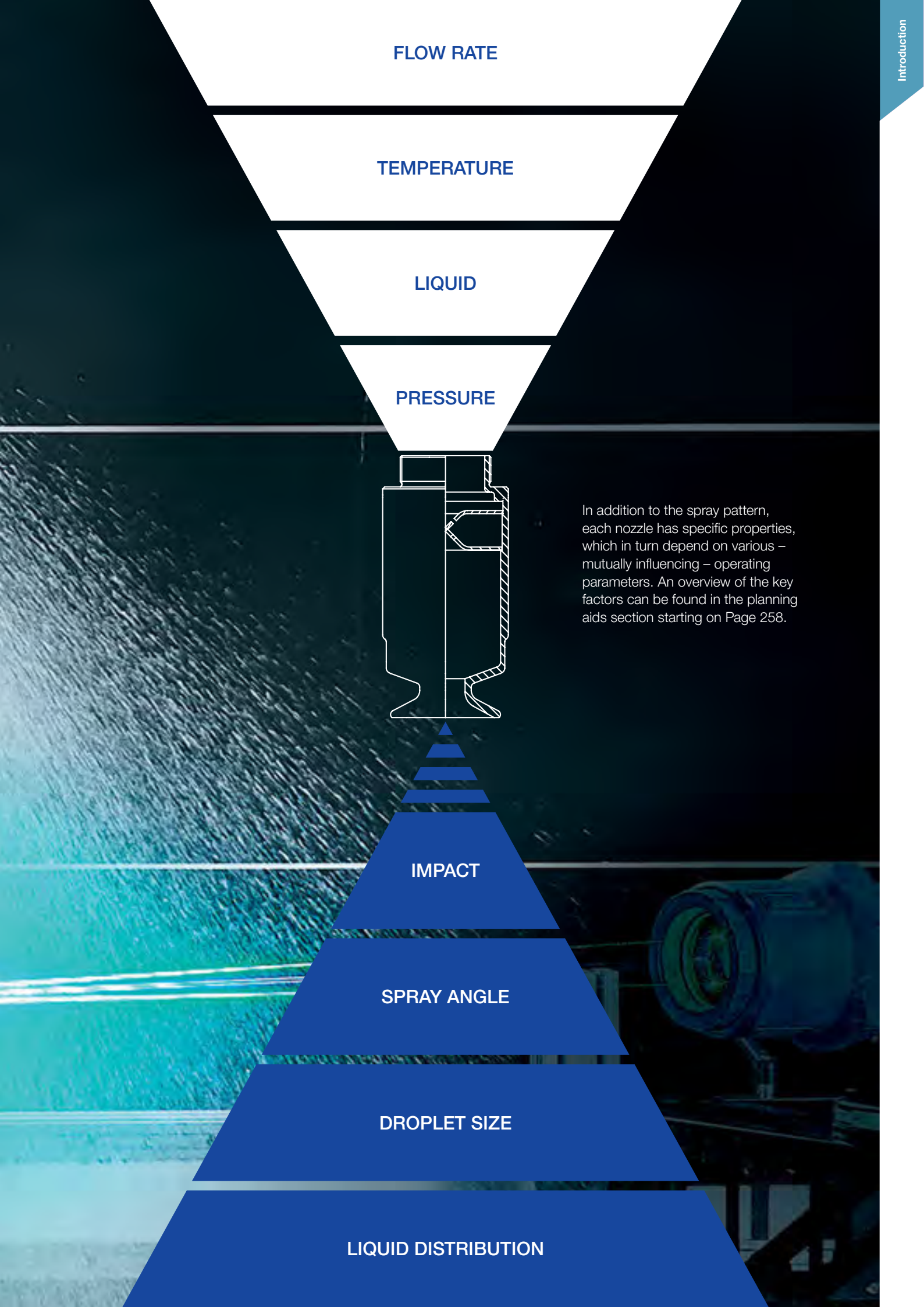

OUR PRODUCT NUMBERS: EVERYTHING YOU NEED TO KNOW IN TEN CHARACTERS

Each Lechler product number not only serves as an order number, it also describes all the essential properties of the associated nozzle.

Product number

632.301.16.CA

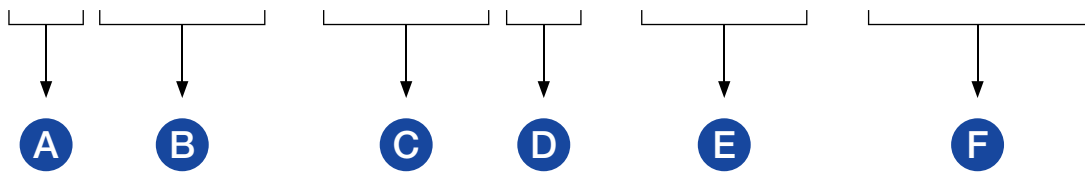

A SPRAY PATTERN

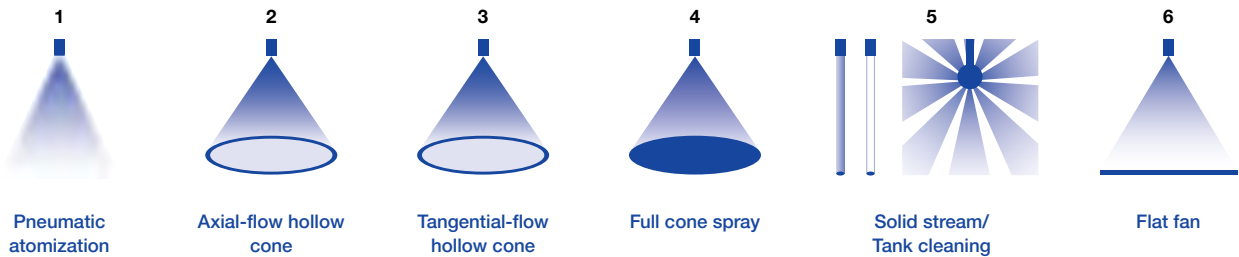

B NOZZLE TYPE/SERIES

C FLOW RATE



The flow rate depends on the respective nozzle type. The exact specifications are shown in the tables on the product pages. The values refer to the measurement with water.

D SPRAY ANGLE



Flat fan: 1 = 20°, 2 = 30°, 3 = 45°, 4 = 60°, 5 = 75°, 6 = 90°, 7 = 120°
Hollow and full cone: 3 = 45°, 4 = 60°, 5 = 80°, 6 = 90°, 8 = 120°/130°
Solid stream: 0 = 0°

E MATERIAL



11 = stainless steel 430F, 1Y = stainless steel 316L, 16 = stainless steel 303,
 17 = stainless steel 316Ti, 30 = brass, 5E = PVDF, 51 = PA, 53 = PP, 55 = PTFE,
 56 = POM, 42 = aluminum.

For individual series, the material may deviate from this numbering system. Refer to the respective product page for details. Special material available on request.

F CONNECTION



1/8" to 4" connections. The exact specifications are shown in the tables on the product pages.

Spray angle	Nozzle type	Material selection								Specification of the connection	Bore Ø	Narrowest free cross section of the nozzle	Flow rate								Spray width	
		Ordering no.				Bore diameter B [mm]	Narrowest free cross section Ø [mm]	V̇ water [l/min]														
		Mat. no.						Code	p [bar]								Spray diameter D [mm]					
		16	17	30	5E	0.5	1.0		2.0*				3.0	5.0	7.0	10.0	H = 200 [mm]	H = 500 [mm]				
20°	632.301	●	●	●	●	CA	CC			0.70	0.60	0.16	0.23	0.32	0.39	1.44	1.65	1.90	160	400		
	632.441	●	●	●	●	CA	CC			1.00	1.10	0.62	0.88	1.25	1.53	4.54	5.20	6.00	160	400		
	632.481	●	●	●	●	CA	CC			1.50	1.20	0.80	1.13	1.60	1.96	5.77	6.60	7.61	160	400		
60°	632.364	●	●	●	●	CA	CC			1.00	0.60	0.31	0.44	0.63	0.77	1.00	1.18	1.40	230	460		
	632.404	●	●	●	●	CA	CC			1.20	0.80	0.50	0.71	1.00	1.23	1.58	1.87	2.24	245	485		
	632.444	●	●	●	●	CA	CC			1.35	0.90	0.62	0.88	1.25	1.53	1.98	2.34	2.80	255	495		
	632.484	●	●	●	●	CA	CC			1.50	1.00	0.80	1.13	1.60	1.96	2.53	2.99	3.58	260	510		

* All the nozzles are designed for a specific reference pressure. This pressure is highlighted in bold in the tables on the product pages. The flow rate specifications at the reference pressure are measured values. The flow rate specifications for a deviating pressure level are calculated values.

Ordering examples

- You are looking for a flat fan nozzle with a 20° spray angle and an approx. 0.3 l/min flow rate at 2 bar. It should be made of stainless steel 303 and come with a 1/8" male thread.

Type	+	Material no.	+	Code	=	Ordering no.
632.301	+	16	+	CA	=	632.301.16.CA

- You are looking for a flat fan nozzle with a 60° spray angle and an approx. 0.6 l/min flow rate at 3 bar. It should be made of brass and come with a 1/4" male threaded connection.

Type	+	Material no.	+	Code	=	Ordering no.
632.364	+	30	+	CC	=	632.364.30.CC

Information on dimensions

- All dimensions in technical drawings and tables are in millimetres (unless stated otherwise).
- Thread sizes BSPP and BSPT are given in inches.

Description of variables in technical drawings

B = bore diameter
 E = narrowest cross-section
 G = thread
 Hex = wrench size
 Flats = wrench size

Product images

The images on the product pages are provided as examples and may deviate in individual cases depending on the actual nozzle size.



➤➤ PNEUMATIC ATOMIZING NOZZLES

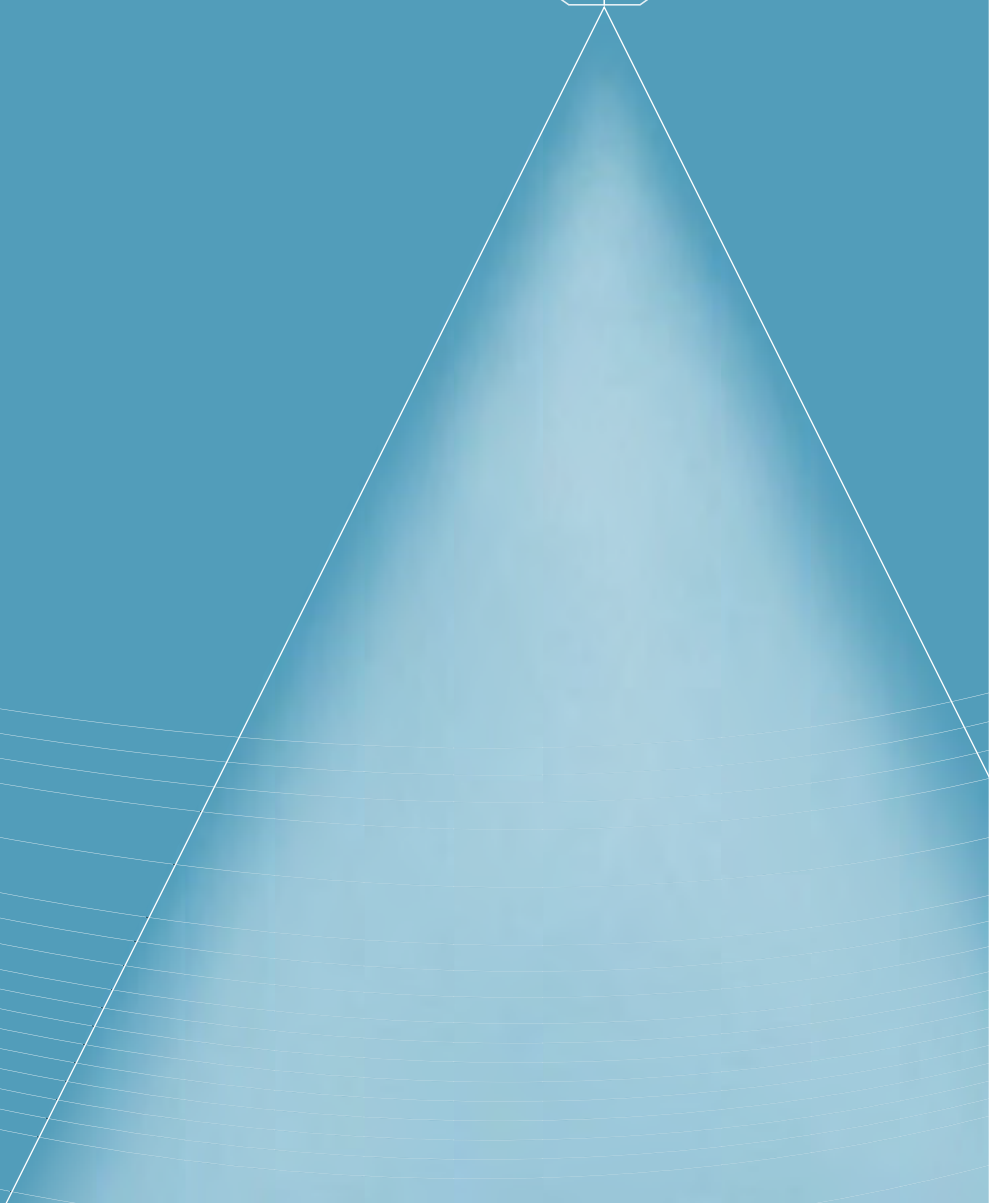
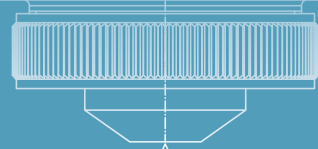
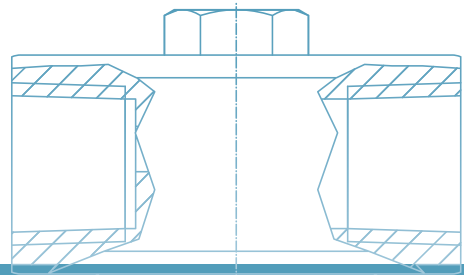

➤ PNEUMATIC ATOMIZING NOZZLES GENERAL INFORMATION



Pneumatic atomizing nozzles produce extremely fine droplets with a small droplet spectrum. They can be split into two types: Internal mixing (for low viscous fluids) and external mixing (for viscous fluids). Gas and liquid are mixed on the inside or outside of the nozzle. Depending on the actual design of the nozzle, the liquid is self-aspirated or supplied under pressure. Various spray jet shapes can be achieved through the design of the nozzle tip.

Pneumatic atomizing nozzles



- Produces extremely fine droplets
- Wide range of liquid-supply
- Internal or external mixing
- Suitable for humidification, cooling and the atomization of viscous fluids

Liquid pressure principle

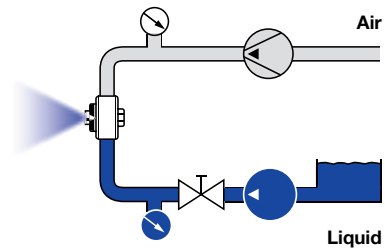

Siphon principle

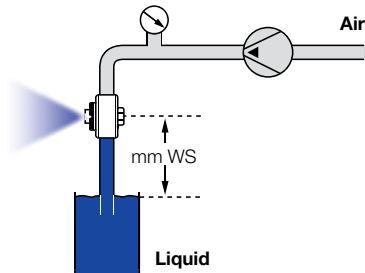



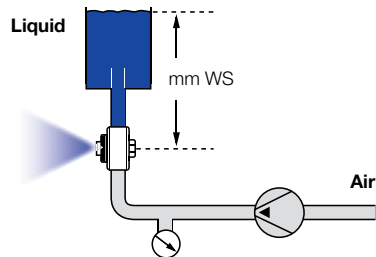

Supply principle







PNEUMATIC ATOMIZING NOZZLES OVERVIEW OF SERIES



		Pneumatic atomizing nozzles				
						
Series		140	176 ViscoMist	170	150	77X, 78X, 79X
Information on page		53	54	on request	on request	on request
Spray character	Full cone spray	•	•	•	•	•
	Flat fan		•			
	Solid stream		•			
Type of liquid supply	Pressure principle		•	•	•	•
	Siphon and/or supply principle	•				
Mixing of media	Internal mixing	•		•		
	External mixing		•		•	•
Flow rate	I/h	4.50–12.00	7.80–307.00	8.50–290.00 [l/min]	0.15–63.00 [l/min]	3.00–1,164.00
Spray angle	Small (15°–30°)	•	•	•	•	•
	Medium (45°)					
	Large (60°–80°)					





					
Series		136.1	136.2	136.3	136.4
Information on page		30	32	33	36
Spray character	Full cone spray	•	•	•	
	Flat fan				•
	Solid stream				
Type of liquid supply	Pressure principle	•	•		•
	Siphon and/or supply principle			•	
Mixing of media	Internal mixing	•	•		•
	External mixing			•	
Flow rate	l/h	0.40–93.20	0.40–132.90	0.30–66.72	0.10–76.10
Spray angle	Small (15°–30°)	•		•	
	Medium (45°)				•
	Large (60°–80°)		•		•

Pneumatic atomizing nozzles					
					
136.5	136.6	166.1	166.2	166.4	166.6
38	40	44	46	47	49
		•	•		
•	•			•	•
	•	•	•	•	•
•					
•		•	•	•	
	•				•
0.80-3.20	1.68-102.10	0.40-93.20	0.40-132.90	0.10-76.10	1.68-102.10
		•			
	•			•	•
•	•		•	•	•

➤ Pneumatic atomizing nozzles, full cone, pressure principle, internal mixing Series 136.1



Features:

- Fine full cone atomization
- Liquid pressure principle
- Internal mixing

Applications:

- Humidification of air
- Cooling

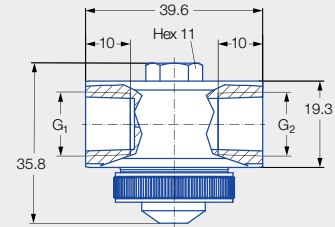

Series 136.1

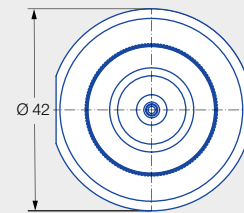
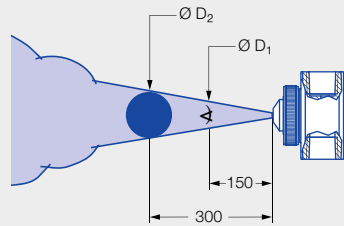

Liquid connection G ₁	Air connection G ₂	Screw plug thread (size 11)	Weight [g] (Stainless steel 303)
1/4 BSPP	1/4 BSPP	5/16-24 UNF-2A	220

Spray angle	Ordering no.		Narrowest free cross section Ø [mm]	Liquid pressure p [bar]												Spray dimensions								
	Type	Mat. no.		0.7				1.5				3.0				4.0				p [bar]	p water [bar]	Ø D ₁ [mm]	Ø D ₂ [mm]	
		1Y		16	p air [bar]	V̇ water [l/h]	V̇ _n air [m ³ /h]	p air [bar]	V̇ water [l/h]	V̇ _n air [m ³ /h]	p air [bar]	V̇ water [l/h]	V̇ _n air [m ³ /h]	p air [bar]	V̇ water [l/h]	V̇ _n air [m ³ /h]								
20°	136.115.xx.A2	●	●	0.5	0.4	5.9	0.3	1.4	5.8	0.8	2.4	9.1	1.1	3.0	11.0	1.2	0.8	0.7	60	100				
					0.8	3.8	0.6	1.8	4.1	1.0	2.8	7.5	1.2	3.4	9.6	1.4	1.8	1.5	60	95				
					1.2	1.7	0.9	2.2	2.2	1.4	3.2	5.9	1.5	3.8	8.2	1.6	2.6	2.0	60	100				
					-	-	-	2.6	1.2	1.7	3.6	4.4	1.8	4.2	6.8	1.9	3.2	3.0	55	95				
					-	-	-	-	-	-	4.0	2.9	2.1	4.6	5.5	2.2	4.4	4.0	55	100				
					-	-	-	-	-	-	4.4	2.0	2.5	5.0	4.1	2.5	-	-	-	-	-			
					-	-	-	-	-	-	4.8	1.1	2.8	5.4	2.9	2.8	-	-	-	-	-			
					-	-	-	-	-	-	5.2	0.4	3.0	5.8	2.1	3.1	-	-	-	-	-			
					136.125.xx.A2	●	●	0.5	0.8	4.7	1.5	1.2	7.0	1.8	2.8	9.1	3.3	3.4	10.6	3.9	1.4	0.7	55	90
									1.2	4.4	1.9	1.6	6.6	2.2	3.2	8.7	3.7	3.8	10.3	4.3	2.2	1.5	55	95
	1.6	4.0	2.3	2.0					6.2	2.6	3.6	8.4	4.1	4.2	9.9	4.6	2.8	2.0	55	100				
	2.0	3.5	2.6	2.4					5.8	3.0	4.0	8.0	4.5	4.6	9.6	5.0	3.4	3.0	60	100				
	2.4	3.0	3.0	2.8					5.4	3.4	4.4	7.7	4.8	5.0	9.3	5.4	4.2	4.0	60	100				
	2.8	2.7	3.2	3.2					4.9	3.7	4.8	7.3	5.2	5.4	8.9	5.8	-	-	-	-	-			
	3.2	2.0	3.7	3.6					4.4	4.1	5.2	7.0	5.6	5.8	8.6	6.1	-	-	-	-	-			
	3.6	1.6	4.1	4.0					3.9	4.5	5.6	6.6	5.9	-	-	-	-	-	-	-	-			
	4.0	1.3	4.5	4.4					3.5	4.8	6.0	6.2	6.3	-	-	-	-	-	-	-	-			
	4.4	1.0	4.9	4.8					3.1	5.2	-	-	-	-	-	-	-	-	-	-	-			
	4.8	0.6	5.2	5.2	2.7	5.6	-	-	-	-	-	-	-	-	-	-	-							
	-	-	-	5.6	2.3	5.9	-	-	-	-	-	-	-	-	-	-	-							
-	-	-	6.0	1.9	6.3	-	-	-	-	-	-	-	-	-	-	-								

Spray angle	Ordering no.		Narrowest free cross section Ø [mm]	Liquid pressure p [bar]												Spray dimensions					
	Type	Mat. no.		0.7			1.5			3.0			4.0			p air [bar]	p water [bar]	Ø D ₁ [mm]	Ø D ₂ [mm]		
		1Y		16	p air [bar]	V̇ water [l/h]	V̇ _n air [m ³ /h]	p air [bar]	V̇ water [l/h]	V̇ _n air [m ³ /h]	p air [bar]	V̇ water [l/h]	V̇ _n air [m ³ /h]	p air [bar]	V̇ water [l/h]					V̇ _n air [m ³ /h]	
20°	136.134.xx.A2	●	●	0.7	1.2	13.2	2.7	2.0	19.4	3.9	3.0	28.3	5.2	3.8	32.6	6.2	1.8	0.7	55	95	
					1.6	12.4	3.3	2.4	18.1	4.4	3.4	27.5	5.7	4.2	32.0	6.8	2.8	1.5	60	105	
					2.0	11.8	3.9	2.8	17.3	4.9	3.8	26.7	6.3	4.6	31.3	7.3	3.8	2.0	60	105	
					2.4	11.4	4.4	3.2	16.7	5.5	4.2	25.9	6.8	5.0	30.6	7.8	5.2	3.0	65	110	
					2.8	11.1	4.9	3.6	16.1	6.0	4.6	25.0	7.3	5.4	29.9	8.4	6.0	4.0	65	110	
					3.2	10.8	5.5	4.0	15.6	6.5	5.0	24.2	7.8	5.8	29.3	8.9	-	-	-	-	-
					3.6	10.6	6.0	4.4	15.2	7.0	5.4	23.6	8.4	-	-	-	-	-	-	-	-
					4.0	10.4	6.5	4.8	15.0	7.6	5.8	23.1	8.9	-	-	-	-	-	-	-	-
					4.4	10.1	7.0	5.2	14.6	8.1	-	-	-	-	-	-	-	-	-	-	-
					4.8	9.9	7.6	5.6	14.1	8.6	-	-	-	-	-	-	-	-	-	-	-
	5.2	9.5	8.1	6.0	13.8	9.1	-	-	-	-	-	-	-	-	-	-	-				
	5.6	9.0	8.6	-	-	-	-	-	-	-	-	-	-	-	-	-	-				
	6.0	8.5	9.2	-	-	-	-	-	-	-	-	-	-	-	-	-	-				
	136.142.xx.A2	●	●	2.5	1.4	24.2	5.1	1.6	53.4	4.7	3.2	70.8	8.0	3.8	93.2	9.2	0.8	0.7	60	100	
					1.8	20.4	6.3	2.0	42.6	5.9	3.6	62.5	9.2	4.2	83.1	10.1	1.6	1.5	65	105	
					2.2	20.0	7.2	2.4	35.3	7.2	4.0	55.7	10.6	4.6	75.3	11.3	3.0	2.0	60	105	
					2.6	19.3	8.2	2.8	30.4	8.4	4.4	49.3	11.7	5.0	69.0	12.5	4.0	3.0	65	110	
					3.0	17.6	9.3	3.2	28.6	9.5	4.8	44.6	12.9	5.4	63.4	13.7	6.0	4.0	65	110	
					3.4	16.5	10.4	3.6	28.2	10.5	5.2	41.9	14.1	5.8	57.5	14.9	-	-	-	-	
					3.8	17.0	11.4	4.0	27.3	11.5	5.6	40.4	15.1	-	-	-	-	-	-	-	
4.2					16.3	12.4	4.4	25.9	12.5	6.0	39.7	16.1	-	-	-	-	-	-	-		
4.6					15.1	13.3	4.8	24.3	13.5	-	-	-	-	-	-	-	-	-	-		
5.0					14.0	14.3	5.2	22.3	14.6	-	-	-	-	-	-	-	-	-	-		
5.4	13.1	15.3	5.6	21.8	15.7	-	-	-	-	-	-	-	-	-	-						
5.8	12.4	16.2	6.0	21.4	16.7	-	-	-	-	-	-	-	-	-	-						

Ordering Type + Material no. = Ordering no.
 example: 136.134.xx.A2 + 1Y = 136.134.1Y.A2

➤ Pneumatic atomizing nozzles, full cone, pressure principle, internal mixing Series 136.2



Features:

- Fine full cone atomization
- Liquid pressure principle
- Internal mixing
- Especially wide spray angle of 60°

Applications:

- Humidification of air
- Cooling

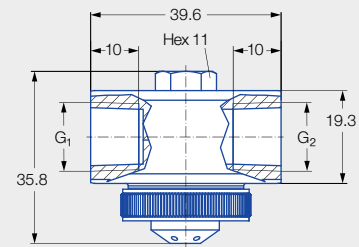

Series 136.2

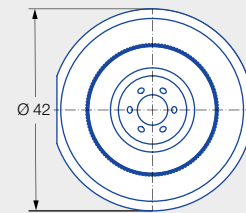
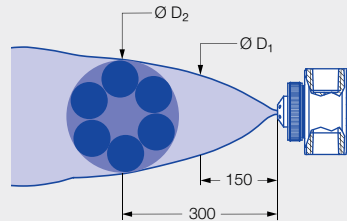

Liquid connection G ₁	Air connection G ₂	Screw plug thread (size 11)	Weight [g] (Stainless steel 303)
1/4 BSPP	1/4 BSPP	5/16-24 UNF-2A	220

Spray angle	Ordering no.		Narrowest free cross section Ø [mm]	Liquid pressure p [bar]												Spray dimensions					
	Type	Mat. no.		0.7			1.5			3.0			4.0			p air [bar]	p water [bar]	Ø D ₁ [mm]	Ø D ₂ [mm]		
		1Y		16	p air [bar]	v̇ water [l/h]	v̇ _n air [m³/h]	p air [bar]	v̇ water [l/h]	v̇ _n air [m³/h]	p air [bar]	v̇ water [l/h]	v̇ _n air [m³/h]	p air [bar]	v̇ water [l/h]					v̇ _n air [m³/h]	
60°	136.215.xx.A2	●	●	0.5	1.0	3.0	1.3	1.6	5.8	1.7	2.8	8.5	2.4	3.8	9.4	3.1	1.0	0.7	200	330	
					1.2	1.8	1.5	1.8	4.9	1.9	3.2	7.2	2.8	4.2	8.2	3.5	1.6	1.5	230	380	
					1.4	0.7	1.8	2.0	3.8	2.1	3.6	5.7	3.2	4.6	6.9	3.9	2.4	2.0	230	385	
					-	-	-	2.2	2.8	2.3	4.0	4.0	3.6	5.0	5.4	4.2	3.2	3.0	245	390	
					-	-	-	2.4	1.7	2.5	4.4	2.2	4.1	5.4	3.8	4.7	4.2	4.0	250	410	
					-	-	-	2.6	0.8	2.8	4.8	0.8	4.5	5.8	2.3	5.2	-	-	-	-	-
	136.222.xx.A2	●	●	1.0	0.8	17.5	2.8	1.6	25.9	4.0	3.0	40.4	5.8	3.8	54.9	6.4	0.8	0.7	250	450	
					1.0	6.0	4.3	1.8	14.7	5.3	3.2	31.5	6.9	4.0	45.6	7.3	1.6	1.5	245	465	
					-	-	-	2.0	6.7	6.7	3.4	22.2	8.2	4.2	37.6	8.5	2.3	2.0	245	465	
					-	-	-	2.2	1.9	8.1	3.6	14.6	9.5	4.4	29.6	9.7	3.2	3.0	250	465	
					-	-	-	-	-	-	-	3.8	8.5	11.0	4.6	21.6	11.2	4.2	4.0	245	465
					-	-	-	-	-	-	4.0	4.5	12.3	4.8	15.3	12.4	-	-	-	-	-
					-	-	-	-	-	-	-	-	-	5.0	9.7	13.8	-	-	-	-	-
					-	-	-	-	-	-	-	-	-	5.2	6.0	15.2	-	-	-	-	-
					-	-	-	-	-	-	-	-	-	5.4	2.9	16.5	-	-	-	-	-
					136.231.xx.A2	●	●	1.4	1.6	25.6	5.1	2.6	44.2	7.0	3.6	93.7	7.9	4.2	132.9	7.3	2.0
	2.0	17.8	6.2	3.0					33.0	8.2	4.0	78.3	9.3	4.6	117.2	9.0	2.6	1.5	245	415	
	2.4	11.3	7.2	3.4					24.7	9.2	4.4	65.8	10.6	5.0	101.1	10.4	2.4	2.0	255	420	
	2.8	6.9	8.1	3.8					18.1	10.2	4.8	54.9	11.9	5.4	87.9	11.8	3.6	3.0	255	425	
	-	-	-	4.2					13.2	11.2	5.2	45.6	13.0	5.8	76.6	13.2	4.2	4.0	265	430	
	-	-	-	4.6					9.3	12.0	5.6	38.0	14.1	6.0	71.2	13.8	-	-	-	-	-
	-	-	-	-					-	-	6.0	36.1	14.4	-	-	-	-	-	-	-	-

Ordering Type + Material no. = Ordering no.
example: 136.215.xx.A2 + 1Y = 136.215.1Y.A2

➤ Pneumatic atomizing nozzles, full cone, siphon principle, external mixing Series 136.3



Features:

- Particularly fine full cone atomization
- Siphon principle
- External mixing

Applications:

- Cooling
- Atomization of viscous liquids
- Chemical industry

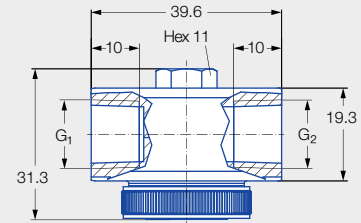

Series 136.3

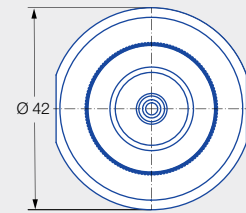
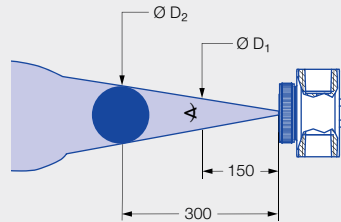

Liquid connection G ₁	Air connection G ₂	Screw plug thread (size 11)	Weight [g] (Stainless steel 303)
1/4 BSPP	1/4 BSPP	5/16-24 UNF-2A	220

Spray angle	Ordering no.		Narrowest free cross section Ø [mm]	Air		V̇ water [l/h]						Spray dimensions							
	Type	Mat. no.		p [bar]	V̇ _n [m³/h]	Water column [mm WS]			Aspiration height [mm WS]			p air [bar]	Aspiration height [mm WS]	Ø D ₁ [mm]	Ø D ₂ [mm]				
		1Y				16	150	300	450	100	200					300	600	900	
20°	136.316.xx.A2	●	●	0.40	0.60	0.70	-	1.38	1.32	-	-	-	-	-	1.40	300	60	110	
					0.80	0.90	1.29	1.44	1.38	-	-	-	-	-	3.20	300	60	120	
					1.20	1.10	1.47	1.62	1.53	1.02	0.84	-	-	-	4.80	300	80	135	
					1.40	1.20	1.50	1.68	1.62	1.14	0.96	0.66	-	-	6.00	300	70	120	
					1.80	1.40	1.62	1.80	1.71	1.26	1.11	0.90	-	-	-	-	-	-	-
					2.00	1.60	1.68	1.86	1.77	1.32	1.17	0.96	-	-	-	-	-	-	-
					2.40	1.80	1.74	1.92	1.86	1.44	1.32	1.14	0.51	-	-	-	-	-	-
					2.60	1.90	1.80	1.98	1.89	1.50	1.32	1.20	0.63	-	-	-	-	-	-
					3.00	2.10	1.92	2.07	1.95	1.59	1.44	1.29	0.84	0.39	-	-	-	-	-
					3.20	2.20	1.95	2.10	1.98	1.65	1.50	1.35	0.96	0.48	-	-	-	-	-
					3.60	2.40	2.07	2.19	2.10	1.80	1.65	1.50	1.14	0.72	-	-	-	-	-
					3.80	2.60	2.13	2.25	2.16	1.83	1.71	1.59	1.23	0.81	-	-	-	-	-
					4.20	2.80	2.22	2.37	2.28	1.95	1.80	1.68	1.38	1.08	-	-	-	-	-
					4.40	2.90	2.25	2.40	2.34	1.98	1.89	1.77	1.44	1.14	-	-	-	-	-
					4.80	3.10	2.25	2.34	2.28	1.92	1.86	1.77	1.50	1.14	-	-	-	-	-
					5.00	3.20	2.25	2.31	2.22	1.89	1.83	1.71	1.41	0.84	-	-	-	-	-
5.40	3.40	2.13	2.25	2.16	1.80	1.68	1.56	1.05	0.30	-	-	-	-	-					
5.60	3.60	2.07	2.19	2.10	1.74	1.65	1.44	0.72	-	-	-	-	-	-					
6.00	3.80	1.98	2.10	1.95	1.56	1.50	1.26	-	-	-	-	-	-	-					





Spray angle	Ordering no.		Narrowest free cross section Ø [mm]	Air		V̇ water [l/h]						Spray dimensions						
	Type	Mat. no.		p [bar]	V̇ _n [m³/h]	Water column [mm WS]			Aspiration height [mm WS]			p air [bar]	Aspiration height [mm WS]	Ø D ₁ [mm]	Ø D ₂ [mm]			
		1Y				16	150	300	450	100	200					300	600	900
20°	136.324.xx.A2	●	●	0.70	0.80	0.90	-	-	-	2.49	1.71	-	-	-	1.20	300	60	115
					1.20	1.10	-	-	-	3.12	2.53	1.86	-	-	3.20	300	65	125
					1.40	1.20	-	-	-	3.36	2.78	2.22	-	-	4.80	300	70	135
					1.80	1.50	-	-	-	3.75	3.22	2.67	-	-	6.00	300	80	135
					2.00	1.60	-	-	-	3.96	3.39	2.85	0.66	-	-	-	-	-
					2.40	1.80	-	-	-	4.29	3.73	3.21	1.41	-	-	-	-	-
					2.60	1.90	-	-	-	4.41	3.91	3.39	1.68	-	-	-	-	-
					3.00	2.10	5.43	-	-	4.71	4.18	3.75	2.07	-	-	-	-	-
					3.20	2.20	5.55	-	-	4.80	4.31	3.90	2.25	-	-	-	-	-
					3.60	2.40	5.82	-	-	5.07	4.56	4.20	2.61	-	-	-	-	-
	3.80	2.60	6.03	-	-	5.22	4.72	4.38	2.88	2.10	-	-	-	-				
	4.20	2.80	6.30	6.66	-	5.64	5.15	4.71	3.21	2.85	-	-	-	-				
	4.40	2.90	6.36	6.72	7.05	5.88	5.38	4.92	3.60	2.97	-	-	-	-				
	4.80	3.10	6.27	6.57	6.84	5.97	5.47	5.22	3.93	1.93	-	-	-	-				
	5.00	3.20	6.12	6.42	6.75	5.88	5.36	5.10	4.05	-	-	-	-	-				
	5.40	3.40	5.82	6.12	6.48	5.49	5.03	4.71	3.81	-	-	-	-	-				
	5.60	3.50	5.67	5.97	6.30	5.22	4.84	4.53	3.63	-	-	-	-	-				
	6.00	3.80	5.31	5.58	6.00	4.80	4.48	4.08	1.92	-	-	-	-	-				
	136.334.xx.A2	●	●	0.70	0.60	1.20	-	-	-	2.19	-	-	-	-	0.80	300	65	120
					0.80	1.40	-	-	-	2.64	2.28	1.44	-	-	3.20	300	65	115
1.20					1.80	-	-	-	3.39	3.00	2.73	0.78	-	4.80	300	70	115	
1.40					2.00	-	-	-	3.69	3.33	3.06	1.11	-	6.00	300	75	120	
1.80					2.30	5.19	-	-	4.20	3.87	3.51	2.16	-	-	-	-	-	
2.00					2.50	5.43	5.97	6.42	4.47	4.08	3.78	2.58	0.84	-	-	-	-	
2.40					2.80	5.79	6.27	6.72	4.86	4.53	4.20	3.30	1.44	-	-	-	-	
2.60					3.00	6.00	6.48	6.90	4.98	4.68	4.41	3.57	1.77	-	-	-	-	
3.00					3.40	6.30	6.75	7.14	5.37	5.07	4.71	3.87	2.31	-	-	-	-	
3.20					3.50	6.42	6.90	7.29	5.52	5.19	4.89	4.02	2.52	-	-	-	-	
3.60	3.90	6.75	7.17	7.59	5.82	5.55	5.19	4.29	3.42	-	-	-	-					
3.80	4.00	6.87	7.32	7.80	6.03	5.73	5.37	4.47	3.81	-	-	-	-					
4.20	4.40	7.29	7.80	8.34	6.39	6.09	5.79	4.83	4.17	-	-	-	-					
4.40	4.60	7.62	8.16	8.73	6.69	6.39	6.09	5.13	4.38	-	-	-	-					
4.80	4.90	8.37	8.85	9.21	7.32	6.99	6.69	5.76	4.86	-	-	-	-					
5.00	5.10	8.52	8.85	9.15	7.71	7.32	7.05	6.06	5.19	-	-	-	-					
5.40	5.40	8.34	8.64	8.88	7.71	7.53	7.29	6.48	5.67	-	-	-	-					
5.60	5.60	8.19	8.49	8.76	7.59	7.41	7.20	6.45	5.73	-	-	-	-					
6.00	5.90	7.86	8.16	8.43	7.26	7.05	6.84	6.15	5.64	-	-	-	-					

Spray angle	Ordering no.		Narrowest free cross section \varnothing [mm]	Air		\dot{V} water [l/h]						Spray dimensions						
	Type	Mat. no.		p [bar]	\dot{V}_n [m ³ /h]	Water column [mm WS]			Aspiration height [mm WS]			p air [bar]	Aspiration height [mm WS]	\varnothing D ₁ [mm]	\varnothing D ₂ [mm]			
		1Y				16	150	300	450	100	200					300	600	900
		Stainless steel 316L				Stainless steel 303												
20°	136.342.xx.A2	●	●	1.50	1.40	3.60	-	-	-	8.82	-	-	3.93	-	1.80	300	70	120
					1.80	4.20	-	-	-	9.45	8.49	7.50	5.22	3.39	3.00	300	70	120
					2.00	4.50	11.97	-	-	9.75	8.91	7.95	5.76	4.05	4.20	300	70	120
					2.40	5.20	12.18	-	-	10.26	9.51	8.73	6.75	5.19	6.00	300	70	120
					2.60	5.50	12.27	13.32	-	10.47	9.75	9.03	7.14	5.58	-	-	-	-
					3.00	6.10	12.27	13.23	14.16	10.65	10.05	9.42	7.74	6.39	-	-	-	-
					3.20	6.40	12.30	13.17	14.07	10.74	10.23	9.63	8.13	6.81	-	-	-	-
					3.60	7.00	12.42	13.20	14.07	11.01	10.53	10.05	8.85	7.86	-	-	-	-
					3.80	7.30	12.54	13.26	14.10	11.28	10.86	10.44	9.30	8.46	-	-	-	-
					4.20	8.00	13.17	13.83	14.49	12.12	11.76	11.40	10.41	9.69	-	-	-	-
					4.40	8.30	13.53	14.13	14.73	12.48	12.15	11.76	10.80	10.08	-	-	-	-
					4.80	8.90	13.98	14.52	15.15	12.99	12.63	12.18	11.19	10.29	-	-	-	-
					5.00	9.20	14.04	14.52	15.15	13.05	12.66	12.30	11.16	10.11	-	-	-	-
					5.40	9.80	13.74	14.31	14.94	12.66	12.24	11.79	10.62	9.21	-	-	-	-
	5.60	10.10	13.35	14.04	14.64	12.27	11.82	11.37	10.08	8.52	-	-	-	-				
	6.00	10.80	12.21	12.90	-	10.98	10.50	10.17	8.70	7.05	-	-	-	-				
	136.351.xx.A2	●	●	2.50	3.20	11.50	-	-	-	-	38.92	-	-	-	3.80	300	95	135
					3.60	12.50	-	-	-	45.73	41.94	-	33.17	-	4.60	300	95	145
					3.80	13.10	-	-	-	47.81	45.14	42.29	35.36	-	5.40	300	100	150
					4.20	14.20	-	-	-	51.61	49.07	46.46	39.58	29.94	6.00	300	95	150
					4.40	14.80	-	-	-	53.10	50.87	48.30	41.59	31.59	-	-	-	-
					4.80	15.90	-	63.39	-	55.30	53.40	51.26	45.06	34.68	-	-	-	-
					5.00	16.50	-	63.75	66.69	56.05	54.15	52.18	46.29	35.88	-	-	-	-
					5.40	17.60	61.12	64.17	66.72	56.71	55.04	53.17	47.62	37.83	-	-	-	-
					5.60	18.10	60.93	63.87	66.48	56.66	55.04	53.22	47.68	38.43	-	-	-	-
					6.00	19.20	59.89	62.88	65.43	55.69	53.98	52.11	45.78	37.05	-	-	-	-

Ordering Type + Material no. = Ordering no.
 example: 136.342.xx.A2 + 1Y = 136.342.1Y.A2

➤ Pneumatic atomizing nozzles, flat fan, pressure principle, internal mixing Series 136.4



Features:

- Fine flat fan atomization
- Pressure principle
- Internal mixing

Applications:

- Humidification of goods
- Cooling
- Belt humidification



Series 136.4

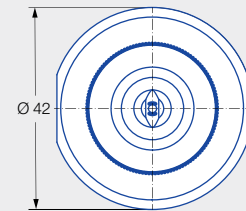
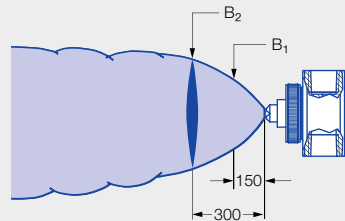
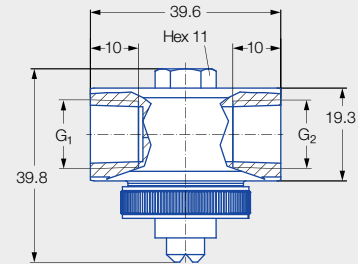

Liquid connection G ₁	Air connection G ₂	Screw plug thread (size 11)	Weight [g] (Stainless steel 303)
1/4 BSPP	1/4 BSPP	5/16-24 UNF-2A	220

Spray angle	Ordering no.		Narrowest free cross section Ø [mm]	Liquid pressure p [bar]												Spray dimensions								
	Type	Mat. no.		0.7				1.5				3.0				4.0				p air [bar]	p water [bar]	B ₁ [mm]	B ₂ [mm]	
		1Y		16	p air [bar]	v̇ water [l/h]	v̇ _n air [m ³ /h]	p air [bar]	v̇ water [l/h]	v̇ _n air [m ³ /h]	p air [bar]	v̇ water [l/h]	v̇ _n air [m ³ /h]	p air [bar]	v̇ water [l/h]	v̇ _n air [m ³ /h]								
45°	136.414.xx.A2	●	●	0.7	1.0	7.7	1.3	1.4	14.3	1.5	2.2	22.4	2.0	3.0	25.1	2.5	1.4	0.7	85	125				
					1.2	6.0	1.5	1.6	13.0	1.6	2.6	20.0	2.3	3.4	23.0	2.8	2.4	1.5	100	145				
					1.4	4.2	1.7	1.8	11.6	1.8	3.0	17.7	2.6	3.8	20.9	3.1	3.2	2.0	105	155				
					1.6	2.7	1.9	2.0	10.2	2.0	3.4	15.5	3.0	4.2	18.9	3.5	3.8	3.0	120	170				
					1.8	1.3	2.1	2.2	8.9	2.2	3.8	13.3	3.4	4.6	16.9	3.8	4.6	4.0	130	210				
					-	-	-	2.4	7.4	2.4	4.2	11.0	3.7	5.0	14.9	4.2	-	-	-	-	-			
					-	-	-	2.6	5.9	2.6	4.6	8.8	4.1	5.4	12.8	4.6	-	-	-	-	-			
					-	-	-	2.8	4.6	2.8	5.0	6.6	4.5	5.8	10.8	5.0	-	-	-	-	-			
					-	-	-	3.0	3.2	3.0	5.4	4.3	4.9	6.0	9.8	5.2	-	-	-	-	-			
					-	-	-	3.2	2.1	3.2	5.8	2.5	5.3	-	-	-	-	-	-	-	-			
	-	-	-	3.4	1.1	3.4	6.0	1.6	5.5	-	-	-	-	-	-	-	-							
	136.443.xx.A2	●	●	1.0	1.2	13.9	1.5	1.6	26.6	1.6	3.0	37.1	2.6	3.6	45.6	2.9	1.2	0.7	110	165				
					1.4	11.9	1.7	1.8	24.3	1.8	3.4	33.1	3.0	4.0	41.9	3.3	2.0	1.5	115	190				
					1.6	9.5	1.9	2.0	22.0	2.0	3.8	29.5	3.4	4.4	38.3	3.7	2.8	2.0	145	190				
					1.8	7.8	2.1	2.2	19.9	2.2	4.2	26.2	3.8	4.8	35.0	4.0	3.8	3.0	150	210				
					-	-	-	2.4	18.0	2.4	4.6	23.0	4.2	5.2	31.8	4.5	4.8	4.0	160	230				
					-	-	-	2.6	16.2	2.6	5.0	20.2	4.6	5.6	29.0	4.9	-	-	-	-	-			
					-	-	-	2.8	14.4	2.8	5.4	17.6	4.9	6.0	26.2	5.2	-	-	-	-	-			
					-	-	-	3.0	12.8	3.0	5.8	14.9	5.3	-	-	-	-	-	-	-	-			
					-	-	-	3.2	11.3	3.2	6.0	14.1	5.5	-	-	-	-	-	-	-	-			
-					-	-	3.4	9.9	3.4	-	-	-	-	-	-	-	-	-	-	-				
-	-	-	3.6	8.8	3.6	-	-	-	-	-	-	-	-	-	-	-								

Spray angle	Ordering no.			Narrowest free cross section Ø [mm]	Liquid pressure p [bar]												Spray dimensions			
	Type	Mat. no.			0.7			1.5			3.0			4.0			p air [bar]	p water [bar]	B ₁ [mm]	B ₂ [mm]
		1Y	16		p air [bar]	V̇ water [l/h]	V̇ _n air [m ³ /h]	p air [bar]	V̇ water [l/h]	V̇ _n air [m ³ /h]	p air [bar]	V̇ water [l/h]	V̇ _n air [m ³ /h]	p air [bar]	V̇ water [l/h]	V̇ _n air [m ³ /h]				
		Stainless steel 316L	Stainless steel 303																	
45°	136.462.xx.A2	●	●	1.5	1.2	19.0	2.6	2.0	22.0	2.0	3.0	61.8	4.0	3.8	76.1	4.6	1.2	0.7	120	140
					1.6	12.2	3.4	2.4	18.0	2.4	3.4	51.9	4.8	4.0	70.4	5.1	2.4	1.5	120	170
					2.0	9.4	4.1	2.8	14.4	2.8	3.8	44.6	5.8	4.2	65.6	5.5	3.2	2.0	120	175
					2.4	7.1	4.8	3.2	11.3	3.2	4.2	39.0	6.6	4.4	61.3	5.9	3.8	3.0	140	205
					2.8	5.7	5.4	3.6	8.8	3.6	4.6	33.4	7.4	4.6	57.3	6.4	6.0	4.0	145	205
					3.2	5.0	6.0	4.0	8.1	3.9	5.0	29.4	8.1	4.8	54.1	6.7	-	-	-	-
					3.6	3.6	6.6	4.4	6.2	4.3	5.4	25.5	8.9	5.0	51.3	7.2	-	-	-	-
					4.0	3.2	7.2	4.8	4.6	4.6	5.8	22.0	9.6	5.2	49.3	7.7	-	-	-	-
					4.4	2.2	7.8	5.2	3.2	4.9	6.0	20.6	9.9	5.4	46.5	8.2	-	-	-	-
					-	-	-	5.6	1.6	5.3	-	-	-	5.6	43.7	8.6	-	-	-	-
					-	-	-	5.8	0.8	5.4	-	-	-	5.8	41.3	8.9	-	-	-	-
					-	-	-	-	-	-	-	-	-	6.0	39.0	9.3	-	-	-	-
					60°	136.425.xx.A2	●	●	0.5	0.8	6.5	1.2	1.4	9.4	1.7	2.4	13.2	2.5	2.4	16.1
1.2	5.5	1.6	1.8	8.7						2.1	2.6	12.9	2.7	2.8	15.5	2.9	2.2	1.5	165	255
1.6	4.7	1.9	2.2	7.9						2.4	3.0	12.3	3.0	3.2	15.0	3.2	3.0	2.0	170	265
2.0	4.0	2.3	2.6	7.2						2.7	3.4	11.8	3.4	3.6	14.5	3.5	3.4	3.0	200	330
2.4	3.2	2.6	3.0	6.4						3.1	3.8	11.1	3.7	4.0	13.9	3.8	5.6	4.0	200	330
2.8	2.6	2.9	3.4	5.7						3.4	4.2	10.4	4.0	4.4	13.4	4.1	-	-	-	-
3.0	2.2	3.1	3.8	5.1						3.7	4.6	9.8	4.3	4.8	12.8	4.5	-	-	-	-
-	-	-	4.0	4.8						3.9	5.0	9.2	4.6	5.2	12.2	4.8	-	-	-	-
-	-	-	4.4	4.2						4.2	5.4	8.6	5.0	5.6	11.7	5.1	-	-	-	-
-	-	-	4.8	3.6						4.5	5.8	8.1	5.3	6.0	11.2	5.4	-	-	-	-
-	-	-	5.2	2.8						4.8	6.0	7.8	5.4	-	-	-	-	-	-	-
-	-	-	5.6	2.2						5.1	-	-	-	-	-	-	-	-	-	-
-	-	-	6.0	1.6						5.5	-	-	-	-	-	-	-	-	-	-
136.452.xx.A2	●	●	1.5	1.0		18.8	3.9	1.8	31.0	5.3	3.2	50.1	7.7	3.8	70.7	8.2	1.0	0.7	130	185
				1.4		8.6	5.7	2.0	25.4	6.3	3.6	39.5	9.4	4.2	58.6	9.6	1.8	1.5	150	240
				1.8		7.4	7.0	2.2	20.1	7.2	4.0	31.3	11.2	4.6	48.6	11.2	2.6	2.0	155	245
				2.2		4.1	8.4	2.4	15.5	8.0	4.4	24.0	12.9	5.0	41.2	13.1	3.6	3.0	175	280
				2.6		1.0	9.8	2.6	12.4	8.9	4.8	17.7	14.5	5.4	33.6	14.8	5.0	4.0	180	285
				2.8		0.1	10.3	2.8	10.4	9.6	5.2	13.4	16.0	5.8	27.5	16.4	-	-	-	-
				-		-	-	-	-	-	5.6	10.6	17.5	6.0	24.4	17.2	-	-	-	-
-	-	-	-	-	-	6.0	8.6	18.8	-	-	-	-	-	-	-					
136.433.xx.A2	●	●	0.4	1.0	11.6	2.0	1.8	18.3	2.8	3.0	31.0	3.7	3.8	37.5	4.4	1.4	0.7	150	210	
				1.2	8.1	2.4	2.0	15.3	3.2	3.4	25.4	4.4	4.2	32.4	5.0	2.2	1.5	185	255	
				1.4	5.3	2.8	2.2	12.2	3.6	3.8	20.6	5.1	4.6	27.7	5.7	3.0	2.0	205	300	
				1.6	3.7	3.2	2.4	9.8	4.0	4.2	16.3	5.9	5.0	23.4	6.5	3.8	4.0	300	485	
				-	-	-	2.6	7.6	4.3	4.6	12.5	6.6	5.4	19.4	7.2	5.2	4.0	260	395	
				-	-	-	2.8	5.9	4.7	5.0	9.3	7.3	5.8	15.9	7.9	-	-	-	-	
				-	-	-	3.0	4.4	5.0	5.4	6.5	8.0	6.0	14.2	8.3	-	-	-	-	

Ordering Type + Material no. = Ordering no.
 example: 136.462.xx.A2 + 1Y = 136.462.1Y.A2

➤ Pneumatic atomizing nozzles, flat fan, siphon principle, internal mixing Series 136.5



Features:

- Particularly fine flat fan atomization
- Siphon principle
- Internal mixing

Applications:

- Humidification of goods
- Cooling
- Belt humidification



Series 136.5

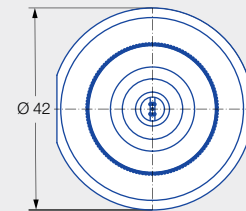
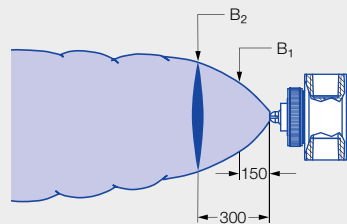
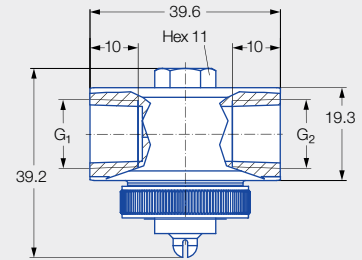

Liquid connection G ₁	Air connection G ₂	Screw plug thread (size 11)	Weight [g] (Stainless steel 303 SS)
1/4 BSPP	1/4 BSPP	5/16-24 UNF-2A	220

Spray angle	Ordering no.		Narrowest free cross section Ø [mm]	Air		V̇ water [l/h]					Spray dimensions							
	Mat. no.			p [bar]	V̇ _n [m³/h]	Water column [mm WS]			Aspiration height [mm WS]		p air [bar]	Aspiration height [mm WS]	B ₁ [mm]	B ₂ [mm]				
	1Y	16				150	300	450	100	200					300	600	900	
60°	136.516.xx.A2	●	●	0.40	0.80	1.80	-	-	-	1.62	1.53	-	1.17	0.88	1.00	300	130	165
					1.20	2.20	1.89	2.13	2.19	1.80	1.77	1.68	1.41	1.16	3.00	300	150	200
					1.40	2.50	1.95	2.16	2.25	1.86	1.80	1.68	1.47	1.21	4.60	300	170	225
					1.80	2.90	1.98	2.22	2.34	1.89	1.86	1.77	1.53	1.26	6.00	300	180	240
					2.00	3.10	1.95	2.19	2.31	1.89	1.80	1.68	1.50	1.26	-	-	-	-
					2.40	3.50	1.89	2.25	2.25	1.83	1.71	1.68	1.47	1.22	-	-	-	-
					2.60	3.70	1.83	2.25	2.25	1.74	1.71	1.59	1.44	1.18	-	-	-	-
					3.00	4.20	1.74	2.01	2.22	1.71	1.62	1.56	1.44	1.28	-	-	-	-
					3.20	4.40	1.71	1.92	2.16	1.65	1.62	1.59	1.59	1.38	-	-	-	-
					3.60	4.80	1.74	1.83	2.10	1.80	1.77	1.74	1.68	1.47	-	-	-	-
					3.80	5.00	1.92	1.80	2.10	1.86	1.86	1.80	1.71	1.49	-	-	-	-
					4.20	5.50	1.98	2.04	2.19	1.92	1.83	1.83	1.68	1.70	-	-	-	-
					4.40	5.70	1.95	2.04	2.19	1.89	1.86	1.80	1.74	1.77	-	-	-	-
					4.80	6.10	2.01	2.04	2.16	2.01	2.01	2.04	2.04	1.98	-	-	-	-
					5.00	6.30	2.10	2.13	2.22	2.19	2.19	2.16	2.10	1.93	-	-	-	-
					5.40	6.80	2.31	2.34	2.28	2.25	2.22	2.16	2.04	1.86	-	-	-	-
5.60	7.00	2.31	2.28	2.25	2.19	2.16	2.10	2.01	1.80	-	-	-	-					
6.00	7.40	2.22	2.22	2.22	2.10	2.10	2.04	1.92	1.79	-	-	-	-					

Spray angle	Ordering no.		Narrowest free cross section \varnothing [mm]	Air		\dot{V} water [l/h]						Spray dimensions						
	Type	Mat. no.		p [bar]	\dot{V}_n [m ³ /h]	Water column [mm WS]			Aspiration height [mm WS]			p air [bar]	Aspiration height [mm WS]	B_1 [mm]	B_2 [mm]			
		1Y				16	150	300	450	100	200					300	600	900
60°	136.525.xx.A2	●	●	0.50	0.60	1.60	-	-	-	2.00	-	-	-	1.00	300	155	240	
					0.80	1.90	-	-	-	2.21	2.10	1.98	-	-	3.00	300	200	295
					1.20	2.30	2.75	2.84	-	2.53	2.39	2.33	2.04	1.69	4.60	300	215	325
					1.40	2.60	2.84	2.90	3.05	2.63	2.51	2.42	2.14	1.82	6.00	300	250	400
					1.80	3.00	2.96	3.01	3.16	2.78	2.64	2.56	2.20	1.88	-	-	-	-
					2.00	3.30	2.94	3.02	3.16	2.73	2.69	2.58	2.18	1.82	-	-	-	-
					2.40	3.70	2.87	2.97	3.10	2.59	2.50	2.38	2.01	1.68	-	-	-	-
					2.60	3.90	2.82	2.86	3.04	2.49	2.46	2.29	1.91	1.62	-	-	-	-
					3.00	4.40	2.59	2.71	2.85	2.23	2.11	2.04	1.73	1.72	-	-	-	-
					3.20	4.60	2.48	2.51	2.71	2.09	1.96	1.91	1.74	1.87	-	-	-	-
					3.60	5.10	2.37	2.31	2.51	2.25	2.18	2.19	1.98	1.90	-	-	-	-
					3.80	5.30	2.34	2.37	2.52	2.22	2.23	2.15	1.99	1.85	-	-	-	-
					4.20	5.70	2.35	2.35	2.43	2.20	2.13	2.11	1.94	1.82	-	-	-	-
					4.40	6.00	2.30	2.32	2.44	2.20	2.07	2.05	1.96	1.83	-	-	-	-
					4.80	6.40	2.25	2.24	2.41	2.12	2.03	2.08	1.90	2.12	-	-	-	-
					5.00	6.60	2.20	2.21	2.37	2.09	2.03	1.98	2.25	2.27	-	-	-	-
5.40	7.10	2.52	2.23	2.36	2.60	2.55	2.49	2.26	2.08	-	-	-	-					
5.60	7.30	2.50	2.45	2.58	2.57	2.54	2.39	2.16	2.02	-	-	-	-					
6.00	7.80	2.57	2.61	2.76	2.37	2.40	2.18	1.94	1.80	-	-	-	-					

Ordering Type + Material no. = Ordering no.
 example: 136.525.xx.A2 + 1Y = 136.525.1Y.A2

➤ Pneumatic atomizing nozzles, flat fan, pressure principle, external mixing Series 136.6



Features:

- Fine flat fan atomization
- Liquid pressure principle
- External mixing

Applications:

- Humidification of goods
- Cooling
- Belt humidification
- Atomization of viscous liquids

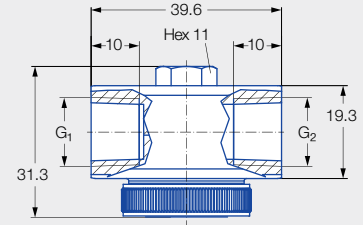

Series 136.6

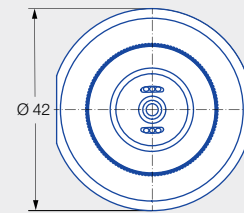
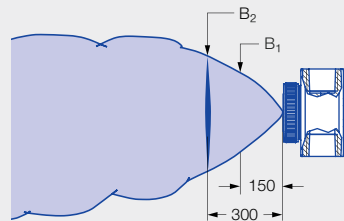

Liquid connection G ₁	Air connection G ₂	Screw plug thread (size 11)	Weight [g] (Stainless steel 303)
1/4 BSPP	1/4 BSPP	5/16-24 UNF-2A	220

Spray angle	Ordering no.		Narrowest free cross section Ø [mm]	Liquid pressure p [bar]												Spray dimensions							
	Type	Mat. no.		0.07				0.15				0.30				0.35				p water [bar]	B ₁ [mm]	B ₂ [mm]	
		1Y		16	p air [bar]	v̇ water [l/h]	v̇ _n air [m ³ /h]	p air [bar]	v̇ water [l/h]	v̇ _n air [m ³ /h]	p air [bar]	v̇ water [l/h]	v̇ _n air [m ³ /h]	p air [bar]	v̇ water [l/h]	v̇ _n air [m ³ /h]							
45°	136.616.xx.A2	●	●	0.40	0.80	1.68	2.50	0.80	2.43	2.40	0.80	3.42	2.50	1.00	3.69	2.80	1.40	0.07	80	115			
					1.20	1.80	3.10	1.00	2.46	2.90	1.20	3.48	3.10	1.40	3.81	3.40	2.20	0.15	90	130			
					1.60	1.92	3.70	1.40	2.58	3.60	1.60	3.51	3.70	1.80	3.87	4.00	3.20	0.20	90	135			
					2.00	2.10	4.30	1.80	2.61	4.20	2.00	3.63	4.30	2.20	3.84	4.60	4.00	0.30	95	145			
					2.40	2.07	4.90	2.20	2.76	4.80	2.40	3.63	4.90	2.60	3.90	5.20	5.00	0.35	100	145			
					2.80	2.19	5.50	2.60	2.73	5.40	2.80	3.63	5.50	3.00	3.93	5.80	-	-	-	-	-		
					3.20	2.19	6.10	3.00	2.73	6.00	3.20	3.63	6.10	3.40	3.90	6.40	-	-	-	-	-		
					3.60	2.22	6.70	3.60	2.76	6.70	3.60	3.66	6.70	3.80	3.93	7.00	-	-	-	-	-		
					4.00	2.22	7.30	4.00	2.76	7.30	4.00	3.69	7.30	4.20	3.96	7.60	-	-	-	-	-		
					4.40	2.22	7.90	4.40	2.76	7.90	4.40	3.69	7.90	4.60	3.93	8.20	-	-	-	-	-		
					4.80	2.22	8.50	4.80	2.76	8.50	4.80	3.69	8.40	5.00	3.93	8.80	-	-	-	-	-		
					5.20	2.22	9.10	5.20	2.76	9.10	5.20	3.66	9.10	5.40	3.93	9.40	-	-	-	-	-		
					5.60	2.22	9.60	5.60	2.76	9.70	5.60	3.66	9.60	5.80	3.87	10.00	-	-	-	-	-		
					6.00	2.22	10.20	6.00	2.73	10.20	6.00	3.66	10.20	6.00	3.87	10.20	-	-	-	-	-		

Spray angle	Ordering no.		Narrowest free cross section Ø [mm]	Liquid pressure p [bar]									Spray dimensions							
	Type	Mat. no.		0.07			0.15			0.30			0.35			p air [bar]	p water [bar]	B ₁ [mm]	B ₂ [mm]	
		1Y		16	p air [bar]	V̇ water [l/h]	V̇ _n air [m ³ /h]	p air [bar]	V̇ water [l/h]	V̇ _n air [m ³ /h]	p air [bar]	V̇ water [l/h]	V̇ _n air [m ³ /h]	p air [bar]	V̇ water [l/h]					V̇ _n air [m ³ /h]
		Stainless steel 316L		Stainless steel 303																
45°	136.635.xx.A2	●	●	0.50	0.80	2.37	2.50	0.80	3.45	2.40	0.80	4.80	2.40	1.00	5.34	2.80	1.40	0.07	85	120
					1.20	2.61	3.10	1.20	3.54	3.10	1.20	5.10	3.10	1.40	5.37	3.40	2.20	0.15	95	130
					1.60	2.85	3.70	1.60	3.66	3.70	1.60	5.01	3.70	1.80	5.46	4.00	3.20	0.20	95	135
					2.00	3.03	4.30	2.00	3.72	4.30	2.10	5.10	4.30	2.20	5.46	4.60	4.00	0.30	100	140
					2.40	3.12	4.90	2.40	3.90	4.90	2.40	5.13	4.90	2.60	5.58	5.20	5.00	0.35	100	145
					2.80	3.15	5.50	2.80	3.87	5.50	2.80	5.16	5.50	3.00	5.58	5.80	-	-	-	-
					3.20	3.21	6.10	3.20	3.96	6.10	3.20	5.22	6.10	3.40	5.58	6.40	-	-	-	-
					3.60	3.18	6.70	3.60	3.96	6.70	3.60	5.25	6.70	3.80	5.58	7.00	-	-	-	-
					4.00	3.21	7.30	4.00	3.96	7.20	4.00	5.22	7.30	4.20	5.58	7.60	-	-	-	-
					4.40	3.21	7.90	4.40	3.96	7.90	4.40	5.22	7.90	4.60	5.58	8.10	-	-	-	-
					4.80	3.21	8.40	4.80	3.96	8.40	4.80	5.22	8.40	5.00	5.58	8.70	-	-	-	-
					5.20	3.21	9.00	5.20	3.96	9.00	5.20	5.22	9.00	5.40	5.58	9.30	-	-	-	-
					5.60	3.12	9.60	5.60	3.90	9.60	5.60	5.22	9.60	5.80	5.58	9.90	-	-	-	-
					6.00	3.18	10.20	6.00	3.84	10.20	6.00	5.16	10.20	6.00	5.58	10.20	-	-	-	-
	136.654.xx.A2	●	●	0.70	0.80	5.25	2.40	0.80	7.29	2.40	1.20	10.11	3.10	1.60	11.07	3.70	1.40	0.07	95	135
					1.20	5.64	3.10	1.20	7.44	3.10	1.60	10.23	3.70	2.00	11.22	4.30	2.20	0.15	100	150
					1.60	5.79	3.70	1.60	7.62	3.70	2.00	10.38	4.30	2.40	11.28	4.90	3.20	0.20	105	160
					2.00	6.18	4.30	2.00	7.86	4.30	2.40	10.47	4.90	2.80	11.31	5.50	4.00	0.30	105	160
					2.40	6.24	4.90	2.40	7.92	4.90	2.80	10.59	5.50	3.20	11.43	6.10	5.00	0.35	105	160
					2.80	6.27	5.50	2.80	8.04	5.50	3.20	10.59	6.10	3.60	11.46	6.60	-	-	-	-
					3.20	6.39	6.10	3.20	8.13	6.10	3.60	10.62	6.70	4.00	11.43	7.20	-	-	-	-
					3.60	6.42	6.60	3.60	8.13	6.70	4.00	10.62	7.20	4.40	11.37	7.80	-	-	-	-
					4.00	6.45	7.20	4.00	8.13	7.20	4.40	10.62	7.80	4.80	11.37	8.40	-	-	-	-
					4.40	6.42	7.80	4.40	8.07	7.80	4.80	10.59	8.40	5.20	11.34	9.00	-	-	-	-
					4.80	6.30	8.40	4.80	8.04	8.40	5.20	10.56	9.00	5.60	11.22	9.60	-	-	-	-
					5.20	6.24	9.00	5.20	7.86	9.00	5.60	10.50	9.60	6.00	11.16	10.10	-	-	-	-
					5.60	6.09	9.60	5.60	7.83	9.60	6.00	10.35	10.20	-	-	-	-	-	-	-
					6.00	5.85	10.20	6.00	7.59	10.20	-	-	-	-	-	-	-	-	-	-
60°	136.626.xx.A2	●	●	0.40	0.80	1.83	2.80	0.80	2.49	2.80	0.80	3.48	2.80	0.80	3.78	2.80	1.60	0.07	85	135
					1.20	1.98	3.60	1.20	2.58	3.50	1.20	3.60	3.50	1.20	3.87	3.60	2.40	0.15	90	140
					1.60	2.10	4.30	1.60	2.70	4.20	1.60	3.66	4.30	1.60	3.90	4.20	3.20	0.20	90	140
					2.00	2.16	4.90	2.00	2.82	4.90	2.00	3.69	4.90	2.00	3.96	4.90	4.00	0.30	100	145
					2.40	2.25	5.60	2.40	2.85	5.60	2.40	3.69	5.60	2.40	3.96	5.60	5.20	0.35	105	150
					2.80	2.34	6.30	2.80	2.88	6.30	2.80	3.72	6.30	2.80	4.02	6.30	-	-	-	-
					3.20	2.31	7.00	3.20	2.88	7.00	3.20	3.78	7.00	3.20	3.99	7.00	-	-	-	-
					3.60	2.34	7.60	3.60	2.88	7.70	3.60	3.78	7.60	3.60	4.02	7.70	-	-	-	-
					4.00	2.40	8.40	4.00	2.94	8.40	4.00	3.81	8.30	4.00	4.05	8.30	-	-	-	-
					4.40	2.40	9.00	4.40	2.91	9.00	4.40	3.81	9.00	4.40	4.02	9.00	-	-	-	-
					4.80	2.40	9.70	4.80	2.97	9.70	4.80	3.81	9.70	4.80	4.08	9.70	-	-	-	-
					5.20	2.43	10.40	5.20	2.97	10.40	5.20	3.81	10.40	5.20	4.05	10.40	-	-	-	-
					5.60	2.43	11.20	5.60	2.97	11.10	5.60	3.81	11.10	5.60	4.05	11.00	-	-	-	-
					6.00	2.43	11.80	6.00	2.97	11.80	6.00	3.81	11.80	6.00	4.05	11.80	-	-	-	-





Spray angle	Ordering no.		Narrowest free cross section Ø [mm]	Liquid pressure p [bar]									Spray dimensions							
	Type	Mat. no.		0.07			0.15			0.30			0.35			p air [bar]	p water [bar]	B ₁ [mm]	B ₂ [mm]	
		1Y		16	p air [bar]	v̇ water [l/h]	v̇ _n air [m ³ /h]	p air [bar]	v̇ water [l/h]	v̇ _n air [m ³ /h]	p air [bar]	v̇ water [l/h]	v̇ _n air [m ³ /h]	p air [bar]	v̇ water [l/h]					v̇ _n air [m ³ /h]
		Stainless steel 316L		Stainless steel 303																
60°	136.645.xx.A2	●	●	0.50	0.80	2.73	2.80	0.80	3.69	2.80	1.00	5.16	3.20	1.00	5.55	3.10	1.60	0.07	100	140
					1.20	2.82	3.50	1.20	3.87	3.50	1.40	5.31	3.90	1.40	5.64	3.90	2.40	0.15	110	150
					1.60	3.09	4.20	1.60	3.99	4.20	1.80	5.37	4.60	1.80	5.67	4.60	3.20	0.20	115	155
					2.00	3.27	4.90	2.00	4.11	4.90	2.20	5.37	5.20	2.20	5.76	5.20	4.00	0.30	125	160
					2.40	3.36	5.60	2.40	4.17	5.60	2.60	5.43	5.90	2.60	5.82	5.90	5.20	0.35	130	165
					2.80	3.39	6.20	2.80	4.20	6.30	3.00	5.49	6.60	3.00	5.82	6.60	-	-	-	-
					3.20	3.45	7.00	3.20	4.26	7.00	3.40	5.49	7.20	3.40	5.88	7.30	-	-	-	-
					3.60	3.48	7.60	3.60	4.29	7.60	3.80	5.55	8.00	3.80	5.88	8.00	-	-	-	-
					4.00	3.51	8.30	4.00	4.32	8.30	4.20	5.55	8.60	4.20	5.88	8.70	-	-	-	-
					4.40	3.54	9.00	4.40	4.35	9.00	4.60	5.58	9.30	4.60	5.94	9.30	-	-	-	-
					4.80	3.57	9.70	4.80	4.38	9.70	5.00	5.55	10.00	5.00	5.94	10.10	-	-	-	-
					5.20	3.57	10.40	5.20	4.35	10.40	5.40	5.61	10.70	5.40	5.94	10.70	-	-	-	-
	5.60	3.60	11.00	5.60	4.35	11.10	5.80	5.61	11.40	5.80	5.94	11.40	-	-	-	-				
	6.00	3.60	11.70	6.00	4.38	11.70	6.00	5.61	11.80	6.00	5.97	11.80	-	-	-	-				
	0.80	5.46	2.80	1.00	7.68	3.20	1.00	10.50	3.20	1.00	11.28	3.20	1.60	0.07	110	140				
	1.20	5.91	3.50	1.40	7.95	3.90	1.40	10.71	3.90	1.40	11.52	3.90	2.40	0.15	130	160				
	1.60	6.15	4.20	1.80	8.13	4.60	1.80	10.83	4.60	1.80	11.58	4.50	3.20	0.20	140	170				
	2.00	6.42	4.90	2.20	8.34	5.30	2.20	11.01	5.30	2.20	11.70	5.20	4.00	0.30	150	180				
	2.40	6.63	5.60	2.60	8.46	5.90	2.60	11.07	5.90	2.60	11.79	5.90	5.20	0.35	155	200				
	2.80	6.75	6.30	3.00	8.58	6.60	3.00	11.16	6.60	3.00	11.88	6.60	-	-	-	-				
	3.20	6.93	6.90	3.40	8.67	7.30	3.40	11.19	7.30	3.40	11.94	7.30	-	-	-	-				
	3.60	6.99	7.60	3.80	8.73	8.00	3.80	11.25	8.00	3.80	12.00	8.00	-	-	-	-				
	4.00	7.05	8.30	4.20	8.76	8.70	4.20	11.28	8.60	4.20	12.03	8.70	-	-	-	-				
	4.40	7.11	9.00	4.60	8.82	9.30	4.60	11.34	9.40	4.60	12.06	9.40	-	-	-	-				
	4.80	7.11	9.70	5.00	8.82	10.10	5.00	11.37	10.00	5.00	12.06	10.10	-	-	-	-				
	5.20	7.17	10.40	5.40	8.82	10.70	5.40	11.37	10.70	5.40	12.09	10.70	-	-	-	-				
	5.60	7.11	11.10	5.80	8.85	11.40	5.80	11.40	11.40	5.80	12.12	11.40	-	-	-	-				
	6.00	7.20	11.80	6.00	8.85	11.80	6.00	11.40	11.70	6.00	12.15	11.80	-	-	-	-				
	0.60	13.89	5.60	1.00	18.51	7.60	1.60	24.81	10.20	2.00	26.61	11.80	1.60	0.07	115	160				
	1.00	14.28	7.60	1.40	18.51	9.30	2.00	24.66	11.70	2.40	26.31	13.50	2.40	0.15	120	160				
	1.40	14.28	9.40	1.80	18.33	11.00	2.40	24.42	13.30	2.80	25.65	15.10	3.20	0.20	120	160				
	1.80	14.10	11.00	2.20	17.91	12.70	2.80	23.52	15.10	3.20	24.57	16.60	4.00	0.30	120	165				
	2.20	13.68	12.60	2.60	17.37	14.20	3.20	22.47	16.60	3.60	23.28	18.30	5.20	0.35	120	170				
	2.60	13.62	14.20	3.00	16.65	15.90	3.60	21.30	18.40	4.00	21.93	19.90	-	-	-	-				
	3.00	13.29	18.90	3.40	15.93	17.30	4.00	20.10	19.80	4.40	20.34	21.50	-	-	-	-				
	3.40	12.87	17.40	3.80	15.06	19.00	4.40	18.78	21.50	4.80	19.20	23.10	-	-	-	-				
3.80	12.57	19.10	4.20	14.58	20.80	4.80	17.52	23.20	5.20	18.06	24.70	-	-	-	-					
4.20	12.18	20.80	4.60	13.83	22.30	5.20	16.71	24.80	5.60	17.01	26.30	-	-	-	-					
4.60	11.79	22.40	5.00	13.08	24.00	5.60	15.63	26.40	6.00	15.87	28.00	-	-	-	-					
5.00	10.95	24.00	5.40	12.30	25.60	5.80	15.12	27.30	-	-	-	-	-	-	-					
5.40	10.44	25.60	5.80	11.52	27.20	6.00	14.76	28.00	-	-	-	-	-	-	-					
5.80	9.57	27.20	6.00	11.04	28.10	-	-	-	-	-	-	-	-	-	-					
6.00	8.97	28.10	-	-	-	-	-	-	-	-	-	-	-	-	-					

Spray angle	Ordering no.		Narrowest free cross section Ø [mm]	Liquid pressure p [bar]												Spray dimensions				
	Type	Mat. no.		0.07			0.15			0.30			0.35			p air [bar]	p water [bar]	B ₁ [mm]	B ₂ [mm]	
		1Y		16	p air [bar]	v̇ water [l/h]	v̇ _n air [m ³ /h]	p air [bar]	v̇ water [l/h]	v̇ _n air [m ³ /h]	p air [bar]	v̇ water [l/h]	v̇ _n air [m ³ /h]	p air [bar]	v̇ water [l/h]					v̇ _n air [m ³ /h]
		Stainless steel 316L		Stainless steel 303																
60°	136.682.xx.A2	●	●	1.50	1.00	22.41	7.50	1.40	28.95	9.30	1.80	41.22	11.10	2.00	44.04	11.80	1.60	0.07	110	155
					1.40	20.19	9.30	1.80	26.07	10.90	2.20	34.92	12.60	2.40	39.09	13.40	2.40	0.15	120	155
					1.80	18.75	11.00	2.20	23.94	12.50	2.60	33.18	14.20	2.80	35.16	15.10	3.20	0.20	120	160
					2.20	17.88	12.50	2.60	22.23	14.30	3.00	30.45	15.90	3.20	32.22	16.70	4.00	0.30	120	165
					2.60	17.10	14.20	3.00	21.12	15.90	3.40	28.29	17.50	3.60	30.18	18.30	5.20	0.35	120	175
					3.00	16.47	15.90	3.40	20.10	17.50	3.80	26.64	19.10	4.00	28.32	19.90	-	-	-	-
					3.40	16.08	17.50	3.80	19.44	19.10	4.20	25.35	20.70	4.40	26.94	21.50	-	-	-	-
					3.80	15.90	19.10	4.20	18.99	20.70	4.60	24.24	22.30	4.80	25.59	23.10	-	-	-	-
					4.20	15.90	20.70	4.60	18.45	22.30	5.00	23.13	24.00	5.20	24.36	24.80	-	-	-	-
					4.60	15.81	22.30	5.00	18.18	24.00	5.40	22.14	25.50	5.60	23.28	26.40	-	-	-	-
					5.00	15.21	23.90	5.40	17.25	25.40	5.80	21.12	27.20	6.00	22.17	28.00	-	-	-	-
					5.40	13.92	25.50	5.80	15.72	27.20	6.00	20.67	28.00	-	-	-	-	-	-	-
	5.80	12.09	27.20	6.00	14.91	28.00	-	-	-	-	-	-	-	-	-	-				
	6.00	11.07	28.00	-	-	-	-	-	-	-	-	-	-	-	-	-				
	136.691.xx.A2	●	●	2.50	1.40	52.00	13.80	2.00	67.30	17.50	2.60	92.30	21.20	2.60	102.10	21.20	1.60	0.07	150	200
					1.80	50.00	16.30	2.40	64.60	20.10	3.00	87.70	23.60	3.00	97.20	23.70	2.40	0.15	160	205
					2.20	48.60	18.80	2.80	62.00	22.50	3.40	84.30	26.00	3.40	92.50	26.10	3.20	0.20	160	205
					2.60	47.50	21.30	3.20	60.40	24.90	3.80	80.70	28.50	3.80	88.40	28.50	4.00	0.30	160	210
					3.00	46.50	23.70	3.60	58.00	27.30	4.20	77.00	30.90	4.20	85.20	31.00	5.20	0.35	150	210
					3.40	45.40	26.10	4.00	56.20	29.80	4.60	74.40	33.40	4.60	81.30	33.40	-	-	-	-
3.80					44.40	28.60	4.40	54.20	32.10	5.00	71.10	35.90	5.00	78.20	35.80	-	-	-	-	
4.20					42.90	31.00	4.80	52.40	34.70	5.40	68.10	38.30	5.40	74.30	38.20	-	-	-	-	
4.60					41.50	33.40	5.20	49.90	37.10	5.80	64.30	40.80	5.80	71.10	40.70	-	-	-	-	
5.00					39.90	35.80	5.60	48.10	39.50	6.00	63.20	42.00	6.00	68.90	41.90	-	-	-	-	
5.40					38.90	38.30	6.00	46.40	42.00	-	-	-	-	-	-	-	-	-	-	
5.60					38.50	39.40	-	-	-	-	-	-	-	-	-	-	-	-	-	

Ordering Type + Material no. = Ordering no.
 example: 136.682.xx.A2 + 1Y = 136.682.1Y.A2

➤ Pneumatic atomizing nozzles, full cone, pressure principle, internal mixing Series 166.1



Features:

- Version with magnetic valve
- Fine full cone atomization
- Liquid pressure principle
- Internal mixing

Applications:

- Humidification of air
- Cooling

Technical data:

- Operating pressure: 0–6 bar
- Voltage: 24 V DC
- Power: 8 W
- Switching frequency: Approx. 500/min
- Protective system: IP 67
- Ambient temperature: +10 °C/+50 °C
- Cable length: 1,000 mm
- Material of gasket: EPDM



Series 166.1

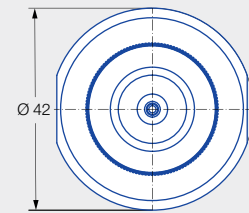
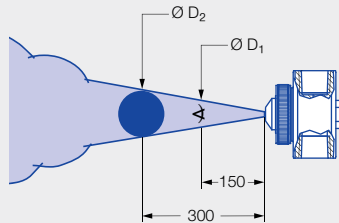
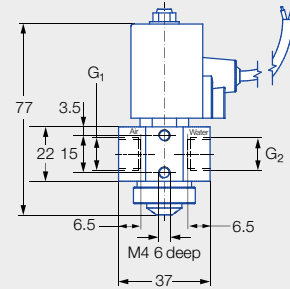

Air connection G ₁	Water connection G ₂	Weight [g]
1/4 BSPP	1/4 BSPP	410

Spray angle	Ordering no.		Narrowest free cross section Ø [mm]	Liquid pressure p [bar]												Spray dimensions						
	Type	Mat. no.		0.7			1.5			3.0			4.0			p air [bar]	p water [bar]	Ø D ₁ [mm]	Ø D ₂ [mm]			
		16		p air [bar]	V̇ water [l/h]	V̇ _n air [m ³ /h]	p air [bar]	V̇ water [l/h]	V̇ _n air [m ³ /h]	p air [bar]	V̇ water [l/h]	V̇ _n air [m ³ /h]	p air [bar]	V̇ water [l/h]	V̇ _n air [m ³ /h]							
20°	166.115.xx.A2	●	0.5	0.4	5.9	0.3	1.4	5.8	0.8	2.4	9.1	1.1	3.0	11.0	1.2	0.8	0.7	60	100			
				0.8	3.8	0.6	1.8	4.1	1.0	2.8	7.5	1.2	3.4	9.6	1.4	1.8	1.5	60	95			
				1.2	1.7	0.9	2.2	2.2	1.4	3.2	5.9	1.5	3.8	8.2	1.6	2.6	2.0	60	100			
				-	-	-	2.6	1.2	1.7	3.6	4.4	1.8	4.2	6.8	1.9	3.2	3.0	55	95			
				-	-	-	-	-	-	4.0	2.9	2.1	4.6	5.5	2.2	4.4	4.0	55	100			
				-	-	-	-	-	-	4.4	2.0	2.5	5.0	4.1	2.5	-	-	-	-	-		
				-	-	-	-	-	-	4.8	1.1	2.8	5.4	2.9	2.8	-	-	-	-	-		
				-	-	-	-	-	-	5.2	0.4	3.0	5.8	2.1	3.1	-	-	-	-	-		
				166.125.xx.A2	●	0.5	0.8	4.7	1.5	1.2	7.0	1.8	2.8	9.1	3.3	3.4	10.6	3.9	1.4	0.7	55	90
							1.2	4.4	1.9	1.6	6.6	2.2	3.2	8.7	3.7	3.8	10.3	4.3	2.2	1.5	55	95
	1.6	4.0	2.3				2.0	6.2	2.6	3.6	8.4	4.1	4.2	9.9	4.6	2.8	2.0	55	100			
	2.0	3.5	2.6				2.4	5.8	3.0	4.0	8.0	4.5	4.6	9.6	5.0	3.4	3.0	60	100			
	2.4	3.0	3.0				2.8	5.4	3.4	4.4	7.7	4.8	5.0	9.3	5.4	4.2	4.0	60	100			
	2.8	2.7	3.2				3.2	4.9	3.7	4.8	7.3	5.2	5.4	8.9	5.8	-	-	-	-	-		
	3.2	2.0	3.7				3.6	4.4	4.1	5.2	7.0	5.6	5.8	8.6	6.1	-	-	-	-	-		
	3.6	1.6	4.1				4.0	3.9	4.5	5.6	6.6	5.9	-	-	-	-	-	-	-	-		
	4.0	1.3	4.5				4.4	3.5	4.8	6.0	6.2	6.3	-	-	-	-	-	-	-	-		
	4.4	1.0	4.9				4.8	3.1	5.2	-	-	-	-	-	-	-	-	-	-	-		
	4.8	0.6	5.2	5.2	2.7	5.6	-	-	-	-	-	-	-	-	-	-	-					
	-	-	-	5.6	2.3	5.9	-	-	-	-	-	-	-	-	-	-	-					
-	-	-	6.0	1.9	6.3	-	-	-	-	-	-	-	-	-	-	-						

Spray angle	Ordering no.		Narrowest free cross section Ø [mm]	Liquid pressure p [bar]												Spray dimensions					
	Type	Mat. no.		0.7			1.5			3.0			4.0								
		16		Stainless steel 303	p air [bar]	\dot{V} water [l/h]	\dot{V}_n air [m³/h]	p air [bar]	\dot{V} water [l/h]	\dot{V}_n air [m³/h]	p air [bar]	\dot{V} water [l/h]	\dot{V}_n air [m³/h]	p air [bar]	\dot{V} water [l/h]	\dot{V}_n air [m³/h]	p air [bar]	p water [bar]	Ø D ₁ [mm]	Ø D ₂ [mm]	
20°	166.134.xx.A2	●	0.7	1.2	13.2	2.7	2.0	19.4	3.9	3.0	28.3	5.2	3.8	32.6	6.2	1.8	0.7	55	95		
				1.6	12.4	3.3	2.4	18.1	4.4	3.4	27.5	5.7	4.2	32.0	6.8	2.8	1.5	60	105		
				2.0	11.8	3.9	2.8	17.3	4.9	3.8	26.7	6.3	4.6	31.3	7.3	3.8	2.0	60	105		
				2.4	11.4	4.4	3.2	16.7	5.5	4.2	25.9	6.8	5.0	30.6	7.8	5.2	3.0	65	110		
				2.8	11.1	4.9	3.6	16.1	6.0	4.6	25.0	7.3	5.4	29.9	8.4	6.0	4.0	65	110		
				3.2	10.8	5.5	4.0	15.6	6.5	5.0	24.2	7.8	5.8	29.3	8.9	-	-	-	-	-	
				3.6	10.6	6.0	4.4	15.2	7.0	5.4	23.6	8.4	-	-	-	-	-	-	-	-	-
				4.0	10.4	6.5	4.8	15.0	7.6	5.8	23.1	8.9	-	-	-	-	-	-	-	-	-
				4.4	10.1	7.0	5.2	14.6	8.1	-	-	-	-	-	-	-	-	-	-	-	-
				4.8	9.9	7.6	5.6	14.1	8.6	-	-	-	-	-	-	-	-	-	-	-	-
	5.2	9.5	8.1	6.0	13.8	9.1	-	-	-	-	-	-	-	-	-	-	-	-			
	5.6	9.0	8.6	-	-	-	-	-	-	-	-	-	-	-	-	-	-	-			
	6.0	8.5	9.2	-	-	-	-	-	-	-	-	-	-	-	-	-	-	-			
	166.142.xx.A2	●	2.5	1.4	24.2	5.1	1.6	53.4	4.7	3.2	70.8	8.0	3.8	93.2	9.2	0.8	0.7	60	100		
				1.8	20.4	6.3	2.0	42.6	5.9	3.6	62.5	9.2	4.2	83.1	10.1	1.6	1.5	65	105		
				2.2	20.0	7.2	2.4	35.3	7.2	4.0	55.7	10.6	4.6	75.3	11.3	3.0	2.0	60	105		
				2.6	19.3	8.2	2.8	30.4	8.4	4.4	49.3	11.7	5.0	69.0	12.5	4.0	3.0	65	110		
				3.0	17.6	9.3	3.2	28.6	9.5	4.8	44.6	12.9	5.4	63.4	13.7	6.0	4.0	65	110		
				3.4	16.5	10.4	3.6	28.2	10.5	5.2	41.9	14.1	5.8	57.5	14.9	-	-	-	-	-	
				3.8	17.0	11.4	4.0	27.3	11.5	5.6	40.4	15.1	-	-	-	-	-	-	-	-	
4.2				16.3	12.4	4.4	25.9	12.5	6.0	39.7	16.1	-	-	-	-	-	-	-	-		
4.6				15.1	13.3	4.8	24.3	13.5	-	-	-	-	-	-	-	-	-	-	-		
5.0				14.0	14.3	5.2	22.3	14.6	-	-	-	-	-	-	-	-	-	-	-		
5.4	13.1	15.3	5.6	21.8	15.7	-	-	-	-	-	-	-	-	-	-	-					
5.8	12.4	16.2	6.0	21.4	16.7	-	-	-	-	-	-	-	-	-	-	-					

Ordering Type + Material no. = Ordering no.
 example: 166.134.xx.A2 + 16 = 166.134.16.A2

➤ Pneumatic atomizing nozzles, full cone, pressure principle, internal mixing Series 166.2



Features:

- Version with magnetic valve
- Fine full cone atomization
- Pressure principle
- Internal mixing
- Especially wide spray angle of 60°

Applications:

- Humidification of air
- Cooling

Technical data:

- Operating pressure: 0–6 bar
- Voltage: 24 V DC
- Power: 8 W
- Switching frequency: Approx. 500/min
- Protective system: IP 67
- Ambient temperature: +10 °C /+50 °C
- Cable length: 1,000 mm
- Material of gasket: EPDM



Series 166.2

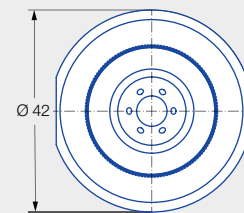
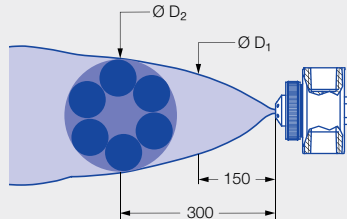
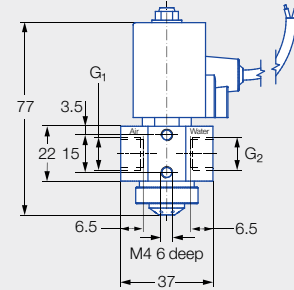

Air connection G ₁	Water connection G ₂	Weight [g]
1/4 BSPP	1/4 BSPP	410

Spray angle	Ordering no.	Narrowest free cross section Ø [mm]	Liquid pressure p [bar]												Spray dimensions																																																																																																																																																																																																																																																																																																																																																																																														
			0.7				1.5				3.0				4.0																																																																																																																																																																																																																																																																																																																																																																																														
			p air [bar]	v water [l/h]	v air [m³/h]		p air [bar]	v water [l/h]	v air [m³/h]		p air [bar]	v water [l/h]	v air [m³/h]		p air [bar]	v water [l/h]	v air [m³/h]		p air [bar]	v water [l/h]	v air [m³/h]	p air [bar]	v water [l/h]	Ø D ₁ [mm]	Ø D ₂ [mm]																																																																																																																																																																																																																																																																																																																																																																																				
60°	166.215.xx.A2	●	0.5	1.0	3.0	1.3	1.6	5.8	1.7	2.8	8.5	2.4	3.8	9.4	3.1	1.0	0.7	200	330	1.2	1.8	1.5	1.8	4.9	1.9	3.2	7.2	2.8	4.2	8.2	3.5	1.6	1.5	230	380	1.4	0.7	1.8	2.0	3.8	2.1	3.6	5.7	3.2	4.6	6.9	3.9	2.4	2.0	230	385	-	-	-	2.2	2.8	2.3	4.0	4.0	3.6	5.0	5.4	4.2	3.2	3.0	245	390	-	-	-	2.4	1.7	2.5	4.4	2.2	4.1	5.4	3.8	4.7	4.2	4.0	250	410	-	-	-	2.6	0.8	2.8	4.8	0.8	4.5	5.8	2.3	5.2	-	-	-	-	-	-	-	-	-	-	-	-	5.0	0.4	4.6	6.0	1.4	5.6	-	-	-	-	-	-	166.222.xx.A2	●	1.0	0.8	17.5	2.8	1.6	25.9	4.0	3.0	40.4	5.8	3.8	54.9	6.4	0.8	0.7	250	450	1.0	6.0	4.3	1.8	14.7	5.3	3.2	31.5	6.9	4.0	45.6	7.3	1.6	1.5	245	465	-	-	-	2.0	6.7	6.7	3.4	22.2	8.2	4.2	37.6	8.5	2.3	2.0	245	465	-	-	-	2.2	1.9	8.1	3.6	14.6	9.5	4.4	29.6	9.7	3.2	3.0	250	465	-	-	-	-	-	-	3.8	8.5	11.0	4.6	21.6	11.2	4.2	4.0	245	465	-	-	-	-	-	-	4.0	4.5	12.3	4.8	15.3	12.4	-	-	-	-	-	-	-	-	-	-	-	-	-	-	-	5.0	9.7	13.8	-	-	-	-	-	-	-	-	-	-	-	-	-	-	-	-	5.2	6.0	15.2	-	-	-	-	-	-	-	-	-	-	-	-	-	-	-	-	5.4	2.9	16.5	-	-	-	-	-	-	-	166.231.xx.A2	●	1.4	1.6	25.6	5.1	2.6	44.2	7.0	3.6	93.7	7.9	4.2	132.9	7.3	2.0	0.7	235	380	2.0	17.8	6.2	3.0	33.0	8.2	4.0	78.3	9.3	4.6	117.2	9.0	2.6	1.5	245	415	2.4	11.3	7.2	3.4	24.7	9.2	4.4	65.8	10.6	5.0	101.1	10.4	2.4	2.0	255	420	2.8	6.9	8.1	3.8	18.1	10.2	4.8	54.9	11.9	5.4	87.9	11.8	3.6	3.0	255	425	-	-	-	4.2	13.2	11.2	5.2	45.6	13.0	5.8	76.6	13.2	4.2	4.0	265	430	-	-	-	4.6	9.3	12.0	5.6	38.0	14.1	6.0	71.2	13.8	-	-	-	-	-	-	-	-	-	-	-	-	6.0	36.1	14.4	-	-	-	-	-	-	-	-	-	-
				166.222.xx.A2	●	1.0	0.8	17.5	2.8	1.6	25.9	4.0	3.0	40.4	5.8	3.8	54.9	6.4	0.8	0.7	250	450	1.0	6.0	4.3	1.8	14.7	5.3	3.2	31.5	6.9	4.0	45.6	7.3	1.6	1.5	245	465	-	-	-	2.0	6.7	6.7	3.4	22.2	8.2	4.2	37.6	8.5	2.3	2.0	245	465	-	-	-	2.2	1.9	8.1	3.6	14.6	9.5	4.4	29.6	9.7	3.2	3.0	250	465	-	-	-	-	-	-	3.8	8.5	11.0	4.6	21.6	11.2	4.2	4.0	245	465	-	-	-	-	-	-	4.0	4.5	12.3	4.8	15.3	12.4	-	-	-	-	-	-	-	-	-	-	-	-	-	-	-	5.0	9.7	13.8	-	-	-				-	-	-	-	-	-	-	-	-	-	-	-	-	5.2	6.0	15.2	-	-	-	-	-	-	-	-	-	-	-	-	-	-	-	-	5.4	2.9	16.5	-	-	-	-	-	-	-	166.231.xx.A2	●	1.4	1.6	25.6	5.1	2.6	44.2	7.0	3.6	93.7	7.9	4.2	132.9	7.3	2.0	0.7	235	380	2.0	17.8	6.2	3.0	33.0	8.2	4.0	78.3	9.3	4.6	117.2	9.0	2.6	1.5	245	415	2.4	11.3	7.2	3.4	24.7	9.2	4.4	65.8	10.6	5.0	101.1	10.4	2.4	2.0	255	420	2.8	6.9	8.1	3.8	18.1	10.2	4.8	54.9	11.9	5.4	87.9	11.8	3.6	3.0	255	425	-	-	-	4.2	13.2	11.2	5.2	45.6	13.0	5.8	76.6	13.2	4.2	4.0	265	430	-	-	-	4.6	9.3	12.0	5.6	38.0	14.1	6.0	71.2	13.8	-	-	-	-	-	-	-	-	-	-	-	-	6.0	36.1	14.4	-	-	-				-	-	-	-	-	-	-																																																																																																														
							166.231.xx.A2	●	1.4	1.6	25.6	5.1	2.6	44.2	7.0	3.6	93.7	7.9	4.2	132.9	7.3	2.0	0.7	235	380	2.0	17.8	6.2	3.0	33.0	8.2	4.0	78.3	9.3	4.6	117.2	9.0	2.6	1.5	245	415	2.4	11.3	7.2	3.4	24.7	9.2	4.4	65.8	10.6	5.0	101.1	10.4	2.4	2.0	255	420	2.8	6.9	8.1	3.8	18.1	10.2	4.8	54.9	11.9	5.4	87.9	11.8	3.6	3.0	255	425	-	-	-	4.2	13.2	11.2	5.2	45.6	13.0	5.8	76.6	13.2	4.2	4.0	265	430	-	-	-	4.6	9.3	12.0	5.6	38.0	14.1	6.0	71.2	13.8	-	-	-	-	-	-	-	-	-	-	-	-	6.0	36.1	14.4	-	-	-				-	-	-	-	-	-	-																																																																																																																																																																																																																																																																												

Ordering Type + Material no. = Ordering no.
example: 166.215.xx.A2 + 16 = 166.215.16.A2

➤ Pneumatic atomizing nozzles, flat fan, pressure principle, internal mixing Series 166.4



Features:

- Version with magnetic valve
- Fine flat fan atomization
- Liquid pressure principle
- Internal mixing

Applications:

- Belt humidification
- Cooling
- Humidification of goods

Technical data:

- Operating pressure: 0–6 bar
- Voltage: 24 V DC
- Power: 8 W
- Switching frequency: Approx. 500/min
- Protective system: IP 67
- Ambient temperature: +10 °C / +50 °C
- Cable length: 1,000 mm
- Material of gasket: EPDM



Series 166.4

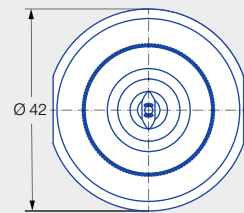
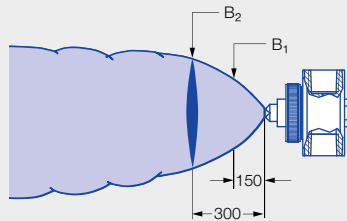
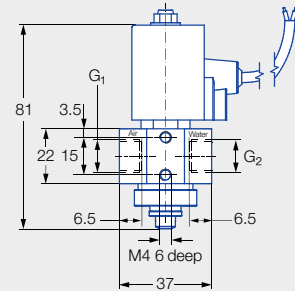

Air connection G ₁	Water connection G ₂	Weight [g]
1/4 BSPP	1/4 BSPP	410

Spray angle	Ordering no.		Narrowest free cross section Ø [mm]	Liquid pressure p [bar]												Spray dimensions							
	Type	Mat. no.		0.7				1.5				3.0				4.0				p [bar]	p [bar]	B ₁ [mm]	B ₂ [mm]
		16		p air [bar]	v water [l/h]	v air [m ³ /h]	p air [bar]	v water [l/h]	v air [m ³ /h]	p air [bar]	v water [l/h]	v air [m ³ /h]	p air [bar]	v water [l/h]	v air [m ³ /h]								
45°	166.414.xx.A2	●	0.7	1.0	7.7	1.3	1.4	14.3	1.5	2.2	22.4	2.0	3.0	25.1	2.5	1.4	0.7	85	125				
				1.2	6.0	1.5	1.6	13.0	1.6	2.6	20.0	2.3	3.4	23.0	2.8	2.4	1.5	100	145				
				1.4	4.2	1.7	1.8	11.6	1.8	3.0	17.7	2.6	3.8	20.9	3.1	3.2	2.0	105	155				
				1.6	2.7	1.9	2.0	10.2	2.0	3.4	15.5	3.0	4.2	18.9	3.5	3.8	3.0	120	170				
				1.8	1.3	2.1	2.2	8.9	2.2	3.8	13.3	3.4	4.6	16.9	3.8	4.6	4.0	130	210				
				-	-	-	2.4	7.4	2.4	4.2	11.0	3.7	5.0	14.9	4.2	-	-	-	-	-			
				-	-	-	2.6	5.9	2.6	4.6	8.8	4.1	5.4	12.8	4.6	-	-	-	-	-			
				-	-	-	2.8	4.6	2.8	5.0	6.6	4.5	5.8	10.8	5.0	-	-	-	-	-			
				-	-	-	3.0	3.2	3.0	5.4	4.3	4.9	6.0	9.8	5.2	-	-	-	-	-			
				-	-	-	3.2	2.1	3.2	5.8	2.5	5.3	-	-	-	-	-	-	-	-			
	-	-	-	3.4	1.1	3.4	6.0	1.6	5.5	-	-	-	-	-	-	-	-						
	166.462.xx.A2	●	1.5	1.2	19.0	2.6	2.0	22.0	2.0	3.0	61.8	4.0	3.8	76.1	4.6	1.2	0.7	120	140				
				1.6	12.2	3.4	2.4	18.0	2.4	3.4	51.9	4.8	4.0	70.4	5.1	2.4	1.5	120	170				
				2.0	9.4	4.1	2.8	14.4	2.8	3.8	44.6	5.8	4.2	65.6	5.5	3.2	2.0	120	175				
				2.4	7.1	4.8	3.2	11.3	3.2	4.2	39.0	6.6	4.4	61.3	5.9	3.8	3.0	140	205				
				2.8	5.7	5.4	3.6	8.8	3.6	4.6	33.4	7.4	4.6	57.3	6.4	6.0	4.0	145	205				
				3.2	5.0	6.0	4.0	8.1	3.9	5.0	29.4	8.1	4.8	54.1	6.7	-	-	-	-				
				3.6	3.6	6.6	4.4	6.2	4.3	5.4	25.5	8.9	5.0	51.3	7.2	-	-	-	-				
				4.0	3.2	7.2	4.8	4.6	4.6	5.8	22.0	9.6	5.2	49.3	7.7	-	-	-	-				
				4.4	2.2	7.8	5.2	3.2	4.9	6.0	20.6	9.9	5.4	46.5	8.2	-	-	-	-				
-				-	-	5.6	1.6	5.3	-	-	-	5.6	43.7	8.6	-	-	-	-					
-	-	-	5.8	0.8	5.4	-	-	-	5.8	41.3	8.9	-	-	-	-								
-	-	-	-	-	-	-	-	-	6.0	39.0	9.3	-	-	-	-								





Spray angle	Ordering no.		Narrowest free cross section Ø [mm]	Liquid pressure p [bar]												Spray dimensions				
	Type	Mat. no.		0.7			1.5			3.0			4.0			p air [bar]	p water [bar]	B ₁ [mm]	B ₂ [mm]	
		16		p air [bar]	V water [l/h]	V ₀ air [m ³ /h]	p air [bar]	V water [l/h]	V ₀ air [m ³ /h]	p air [bar]	V water [l/h]	V ₀ air [m ³ /h]	p air [bar]	V water [l/h]	V ₀ air [m ³ /h]					
60°	166.425.xx.A2	●	0.5	0.8	6.5	1.2	1.4	9.4	1.7	2.4	13.2	2.5	2.4	16.1	2.5	1.2	0.7	155	195	
				1.2	5.5	1.6	1.8	8.7	2.1	2.6	12.9	2.7	2.8	15.5	2.9	2.2	1.5	165	255	
				1.6	4.7	1.9	2.2	7.9	2.4	3.0	12.3	3.0	3.2	15.0	3.2	3.0	2.0	170	265	
				2.0	4.0	2.3	2.6	7.2	2.7	3.4	11.8	3.4	3.6	14.5	3.5	3.4	3.0	200	330	
				2.4	3.2	2.6	3.0	6.4	3.1	3.8	11.1	3.7	4.0	13.9	3.8	5.6	4.0	200	330	
				2.8	2.6	2.9	3.4	5.7	3.4	4.2	10.4	4.0	4.4	13.4	4.1	-	-	-	-	-
				3.0	2.2	3.1	3.8	5.1	3.7	4.6	9.8	4.3	4.8	12.8	4.5	-	-	-	-	-
				-	-	-	4.0	4.8	3.9	5.0	9.2	4.6	5.2	12.2	4.8	-	-	-	-	-
				-	-	-	4.4	4.2	4.2	5.4	8.6	5.0	5.6	11.7	5.1	-	-	-	-	-
				-	-	-	4.8	3.6	4.5	5.8	8.1	5.3	6.0	11.2	5.4	-	-	-	-	-
	-	-	-	5.2	2.8	4.8	6.0	7.8	5.4	-	-	-	-	-	-	-	-			
	-	-	-	5.6	2.2	5.1	-	-	-	-	-	-	-	-	-	-	-			
	-	-	-	6.0	1.6	5.5	-	-	-	-	-	-	-	-	-	-	-			
	166.452.xx.A2	●	1.5	1.0	18.8	3.9	1.8	31.0	5.3	3.2	50.1	7.7	3.8	70.7	8.2	1.0	0.7	130	185	
				1.4	8.6	5.7	2.0	25.4	6.3	3.6	39.5	9.4	4.2	58.6	9.6	1.8	1.5	150	240	
				1.8	7.4	7.0	2.2	20.1	7.2	4.0	31.3	11.2	4.6	48.6	11.2	2.6	2.0	155	245	
				2.2	4.1	8.4	2.4	15.5	8.0	4.4	24.0	12.9	5.0	41.2	13.1	3.6	3.0	175	280	
				2.6	1.0	9.8	2.6	12.4	8.9	4.8	17.7	14.5	5.4	33.6	14.8	5.0	4.0	180	285	
				2.8	0.1	10.3	2.8	10.4	9.6	5.2	13.4	16.0	5.8	27.5	16.4	-	-	-	-	-
				-	-	-	-	-	-	5.6	10.6	17.5	6.0	24.4	17.2	-	-	-	-	-
-				-	-	-	-	-	6.0	8.6	18.8	-	-	-	-	-	-	-	-	
166.433.xx.A2	●	0.4	1.0	11.6	2.0	1.8	18.3	2.8	3.0	31.0	3.7	3.8	37.5	4.4	1.4	0.7	150	210		
			1.2	8.1	2.4	2.0	15.3	3.2	3.4	25.4	4.4	4.2	32.4	5.0	2.2	1.5	185	255		
			1.4	5.3	2.8	2.2	12.2	3.6	3.8	20.6	5.1	4.6	27.7	5.7	3.0	2.0	205	300		
			1.6	3.7	3.2	2.4	9.8	4.0	4.2	16.3	5.9	5.0	23.4	6.5	3.8	4.0	300	485		
			-	-	-	2.6	7.6	4.3	4.6	12.5	6.6	5.4	19.4	7.2	5.2	4.0	260	395		
			-	-	-	2.8	5.9	4.7	5.0	9.3	7.3	5.8	15.9	7.9	-	-	-	-	-	
			-	-	-	3.0	4.4	5.0	5.4	6.5	8.0	6.0	14.2	8.3	-	-	-	-	-	

Ordering Type + Material no. = Ordering no.
 example: 166.425.xx.A2 + 16 = 166.425.16.A2

➤ Pneumatic atomizing nozzles, flat fan, pressure principle, external mixing Series 166.6

Features:

- Version with magnetic valve
- Fine flat fan atomization
- Liquid pressure principle
- External mixing

Applications:

- Belt humidification
- Cooling
- Humidification of goods
- Atomization of viscous liquids

Technical data:

- Operating pressure: 0–6 bar
- Voltage: 24 V DC
- Power: 8 W
- Switching frequency: Approx. 500/min
- Protective system: IP 67
- Ambient temperature: +10 °C /+50 °C
- Cable length: 1,000 mm
- Material of gasket: EPDM



Series 166.6

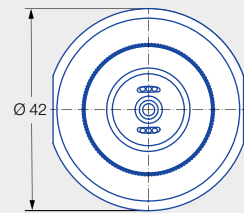
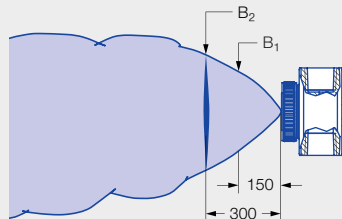
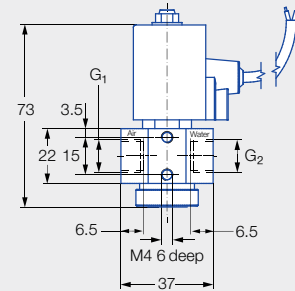

Air connection G ₁	Water connection G ₂	Weight [g]
1/4 BSPP	1/4 BSPP	410

Spray angle	Ordering no.		Narrowest free cross section Ø [mm]	Liquid pressure p [bar]												Spray dimensions							
	Type	Mat. no.		0.07				0.15				0.30				0.35				p air [bar]	p water [bar]	B ₁ [mm]	B ₂ [mm]
		16		Stainless steel 303	p air [bar]	v̇ water [l/h]	v̇ air [m³/h]	p air [bar]	v̇ water [l/h]	v̇ air [m³/h]	p air [bar]	v̇ water [l/h]	v̇ air [m³/h]	p air [bar]	v̇ water [l/h]	v̇ air [m³/h]							
45°	166.616.xx.A2	●	0.40	0.80	1.68	2.50	0.80	2.43	2.40	0.80	3.42	2.50	1.00	3.69	2.80	1.40	0.07	80	115				
				1.20	1.80	3.10	1.00	2.46	2.90	1.20	3.48	3.10	1.40	3.81	3.40	2.20	0.15	90	130				
				1.60	1.92	3.70	1.40	2.58	3.60	1.60	3.51	3.70	1.80	3.87	4.00	3.20	0.20	90	135				
				2.00	2.10	4.30	1.80	2.61	4.20	2.00	3.63	4.30	2.20	3.84	4.60	4.00	0.30	95	145				
				2.40	2.07	4.90	2.20	2.76	4.80	2.40	3.63	4.90	2.60	3.90	5.20	5.00	0.35	100	145				
				2.80	2.19	5.50	2.60	2.73	5.40	2.80	3.63	5.50	3.00	3.93	5.80	-	-	-	-	-			
				3.20	2.19	6.10	3.00	2.73	6.00	3.20	3.63	6.10	3.40	3.90	6.40	-	-	-	-	-			
				3.60	2.22	6.70	3.60	2.76	6.70	3.60	3.66	6.70	3.80	3.93	7.00	-	-	-	-	-			
				4.00	2.22	7.30	4.00	2.76	7.30	4.00	3.69	7.30	4.20	3.96	7.60	-	-	-	-	-			
				4.40	2.22	7.90	4.40	2.76	7.90	4.40	3.69	7.90	4.60	3.93	8.20	-	-	-	-	-			
	4.80	2.22	8.50	4.80	2.76	8.50	4.80	3.69	8.40	5.00	3.93	8.80	-	-	-	-	-						
	5.20	2.22	9.10	5.20	2.76	9.10	5.20	3.66	9.10	5.40	3.93	9.40	-	-	-	-	-						
	5.60	2.22	9.60	5.60	2.76	9.70	5.60	3.66	9.60	5.80	3.87	10.00	-	-	-	-	-						
	6.00	2.22	10.20	6.00	2.73	10.20	6.00	3.66	10.20	6.00	3.87	10.20	-	-	-	-	-						
	0.80	5.25	2.40	0.80	7.29	2.40	1.20	10.11	3.10	1.60	11.07	3.70	1.40	0.07	95	135							
	1.20	5.64	3.10	1.20	7.44	3.10	1.60	10.23	3.70	2.00	11.22	4.30	2.20	0.15	100	150							
	1.60	5.79	3.70	1.60	7.62	3.70	2.00	10.38	4.30	2.40	11.28	4.90	3.20	0.20	105	160							
	2.00	6.18	4.30	2.00	7.86	4.30	2.40	10.47	4.90	2.80	11.31	5.50	4.00	0.30	105	160							
	2.40	6.24	4.90	2.40	7.92	4.90	2.80	10.59	5.50	3.20	11.43	6.10	5.00	0.35	105	160							
	2.80	6.27	5.50	2.80	8.04	5.50	3.20	10.59	6.10	3.60	11.46	6.60	-	-	-	-	-						
3.20	6.39	6.10	3.20	8.13	6.10	3.60	10.62	6.70	4.00	11.43	7.20	-	-	-	-	-							
3.60	6.42	6.60	3.60	8.13	6.70	4.00	10.62	7.20	4.40	11.37	7.80	-	-	-	-	-							
4.00	6.45	7.20	4.00	8.13	7.20	4.40	10.62	7.80	4.80	11.37	8.40	-	-	-	-	-							
4.40	6.42	7.80	4.40	8.07	7.80	4.80	10.59	8.40	5.20	11.34	9.00	-	-	-	-	-							
4.80	6.30	8.40	4.80	8.04	8.40	5.20	10.56	9.00	5.60	11.22	9.60	-	-	-	-	-							
5.20	6.24	9.00	5.20	7.86	9.00	5.60	10.50	9.60	6.00	11.16	10.10	-	-	-	-	-							
5.60	6.09	9.60	5.60	7.83	9.60	6.00	10.35	10.20	-	-	-	-	-	-	-	-							
6.00	5.85	10.20	6.00	7.59	10.20	-	-	-	-	-	-	-	-	-	-	-							





Spray angle	Ordering no.		Narrowest free cross section Ø [mm]	Liquid pressure p [bar]												Spray dimensions				
	Type	Mat. no.		0.07			0.15			0.30			0.35			p air [bar]	p water [bar]	B ₁ [mm]	B ₂ [mm]	
		16		p air [bar]	V water [l/h]	V air [m³/h]	p air [bar]	V water [l/h]	V air [m³/h]	p air [bar]	V water [l/h]	V air [m³/h]	p air [bar]	V water [l/h]	V air [m³/h]					
60°	166.626.xx.A2	●	0.40	0.80	1.83	2.80	0.80	2.49	2.80	0.80	3.48	2.80	0.80	3.78	2.80	1.60	0.07	85	135	
				1.20	1.98	3.60	1.20	2.58	3.50	1.20	3.60	3.50	1.20	3.87	3.60	2.40	0.15	90	140	
				1.60	2.10	4.30	1.60	2.70	4.20	1.60	3.66	4.30	1.60	3.90	4.20	3.20	0.20	90	140	
				2.00	2.16	4.90	2.00	2.82	4.90	2.00	3.69	4.90	2.00	3.96	4.90	4.00	0.30	100	145	
				2.40	2.25	5.60	2.40	2.85	5.60	2.40	3.69	5.60	2.40	3.96	5.60	5.20	0.35	105	150	
				2.80	2.34	6.30	2.80	2.88	6.30	2.80	3.72	6.30	2.80	4.02	6.30	-	-	-	-	
				3.20	2.31	7.00	3.20	2.88	7.00	3.20	3.78	7.00	3.20	3.99	7.00	-	-	-	-	
				3.60	2.34	7.60	3.60	2.88	7.70	3.60	3.78	7.60	3.60	4.02	7.70	-	-	-	-	
				4.00	2.40	8.40	4.00	2.94	8.40	4.00	3.81	8.30	4.00	4.05	8.30	-	-	-	-	
				4.40	2.40	9.00	4.40	2.91	9.00	4.40	3.81	9.00	4.40	4.02	9.00	-	-	-	-	
				4.80	2.40	9.70	4.80	2.97	9.70	4.80	3.81	9.70	4.80	4.08	9.70	-	-	-	-	
				5.20	2.43	10.40	5.20	2.97	10.40	5.20	3.81	10.40	5.20	4.05	10.40	-	-	-	-	
	5.60	2.43	11.20	5.60	2.97	11.10	5.60	3.81	11.10	5.60	4.05	11.00	-	-	-	-				
	6.00	2.43	11.80	6.00	2.97	11.80	6.00	3.81	11.80	6.00	4.05	11.80	-	-	-	-				
		166.682xx.A2	●	1.50	1.00	22.41	7.50	1.40	28.95	9.30	1.80	41.22	11.10	2.00	44.04	11.80	1.60	0.07	110	155
	1.40				20.19	9.30	1.80	26.07	10.90	2.20	34.92	12.60	2.40	39.09	13.40	2.40	0.15	120	155	
	1.80				18.75	11.00	2.20	23.94	12.50	2.60	33.18	14.20	2.80	35.16	15.10	3.20	0.20	120	160	
	2.20				17.88	12.50	2.60	22.23	14.30	3.00	30.45	15.90	3.20	32.22	16.70	4.00	0.30	120	165	
	2.60				17.10	14.20	3.00	21.12	15.90	3.40	28.29	17.50	3.60	30.18	18.30	5.20	0.35	120	175	
	3.00				16.47	15.90	3.40	20.10	17.50	3.80	26.64	19.10	4.00	28.32	19.90	-	-	-	-	
	3.40				16.08	17.50	3.80	19.44	19.10	4.20	25.35	20.70	4.40	26.94	21.50	-	-	-	-	
	3.80				15.90	19.10	4.20	18.99	20.70	4.60	24.24	22.30	4.80	25.59	23.10	-	-	-	-	
	4.20				15.90	20.70	4.60	18.45	22.30	5.00	23.13	24.00	5.20	24.36	24.80	-	-	-	-	
	4.60				15.81	22.30	5.00	18.18	24.00	5.40	22.14	25.50	5.60	23.28	26.40	-	-	-	-	
	5.00				15.21	23.90	5.40	17.25	25.40	5.80	21.12	27.20	6.00	22.17	28.00	-	-	-	-	
	5.40				13.92	25.50	5.80	15.72	27.20	6.00	20.67	28.00	-	-	-	-	-	-	-	
	5.80	12.09	27.20	6.00	14.91	28.00	-	-	-	-	-	-	-	-	-	-				
	6.00	11.07	28.00	-	-	-	-	-	-	-	-	-	-	-	-	-				
		166.691.xx.A2	●	2.50	1.40	52.00	13.80	2.00	67.30	17.50	2.60	92.30	21.20	2.60	102.10	21.20	1.60	0.07	150	200
	1.80				50.00	16.30	2.40	64.60	20.10	3.00	87.70	23.60	3.00	97.20	23.70	2.40	0.15	160	205	
	2.20				48.60	18.80	2.80	62.00	22.50	3.40	84.30	26.00	3.40	92.50	26.10	3.20	0.20	160	205	
	2.60				47.50	21.30	3.20	60.40	24.90	3.80	80.70	28.50	3.80	88.40	28.50	4.00	0.30	160	210	
	3.00				46.50	23.70	3.60	58.00	27.30	4.20	77.00	30.90	4.20	85.20	31.00	5.20	0.35	150	210	
	3.40				45.40	26.10	4.00	56.20	29.80	4.60	74.40	33.40	4.60	81.30	33.40	-	-	-	-	
	3.80				44.40	28.60	4.40	54.20	32.10	5.00	71.10	35.90	5.00	78.20	35.80	-	-	-	-	
	4.20				42.90	31.00	4.80	52.40	34.70	5.40	68.10	38.30	5.40	74.30	38.20	-	-	-	-	
4.60	41.50				33.40	5.20	49.90	37.10	5.80	64.30	40.80	5.80	71.10	40.70	-	-	-	-		
5.00	39.90				35.80	5.60	48.10	39.50	6.00	63.20	42.00	6.00	68.90	41.90	-	-	-	-		
5.40	38.90				38.30	6.00	46.40	42.00	-	-	-	-	-	-	-	-	-	-		
5.60	38.50				39.40	-	-	-	-	-	-	-	-	-	-	-	-	-		

Ordering Type + Material no. = Ordering no.
 example: 166.626.xx.A2 + 16 = 166.626.16.A2

Accessories for pneumatic atomizing nozzles

Series 136.1 to 136.6

Overview of accessories

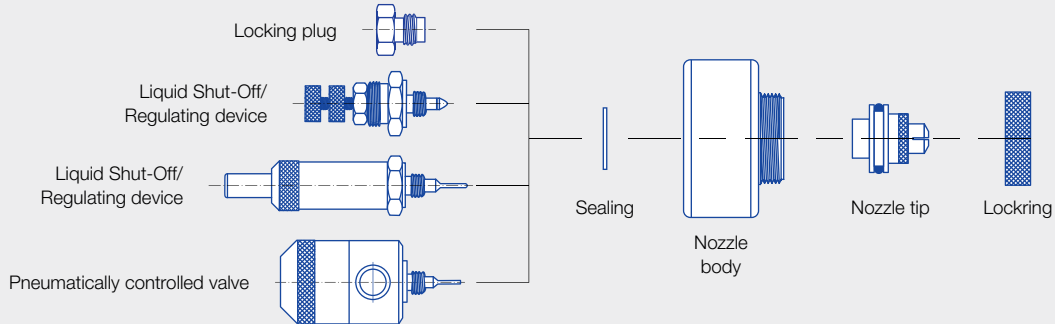

Regulating device and shut-off needle

Enables manual regulation of the flow rate and closing of the nozzle.

Material: Stainless steel 303
Weight: 33 g

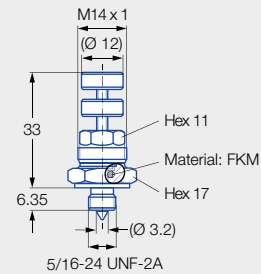

Ordering no.

Type

013.600.16

Suitable for all nozzles of series 136

Regulating device with quick-cleaning needle

Enables manual regulation of the flow rate and cleaning of the nozzle orifice.

Material: Stainless steel 303
Weight: 75 g

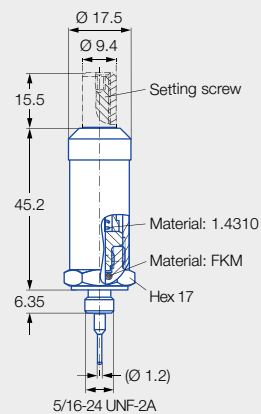

Ordering no.

Type

013.601.16.30

013.602.16.30

013.603.16.30

013.604.16.30

013.605.16.30

013.606.16.30

For nozzles

136.xx1

136.xx2

136.xx3

136.xx4

136.xx5

136.xx6

Needle diameter
D
[mm]

2.1

1.2

0.8

0.6

0.4

0.3



Pneumatically controlled valve. Opening pressure 2.1 bar, max. 180 cycles/min.

External control system via separate compressed air connection for switching the nozzle on and off.

Material: Stainless steel 303
Weight: 230 g

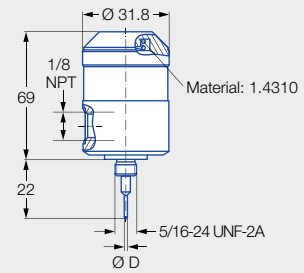

Ordering no.	For nozzles	Needle diameter D [mm]
Type		
013.601.16.10	136.xx1	2.1
013.602.16.10	136.xx2	1.2
013.603.16.10	136.xx3	0.8
013.604.16.10	136.xx4	0.6
013.605.16.10	136.xx5	0.4
013.606.16.10	136.xx6	0.3

➤ Pneumatic atomizing nozzles, full cone, siphon principle, internal mixing Series 140

Features:

- Particularly fine full cone atomization
- Siphon principle
- Internal mixing
- Integrated regulating device
- Material: Brass

Applications:

- Lubrication
- Cooling
- Humidification of air



Series 140

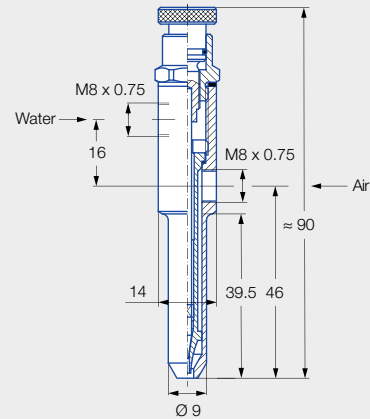

Mat. no.	Weight [g]
30	70

Spray angle	Ordering no.	Narrowest free cross section Ø [mm]		Hs Aspiration height [mm WS]	Flow rate							
		Water	Air		0.5		1.0		2.0		3.0	
					\dot{V}_W [l/h]	$\dot{V}_n L$ [m³/h]	\dot{V}_W [l/h]	$\dot{V}_n L$ [m³/h]	\dot{V}_W [l/h]	$\dot{V}_n L$ [m³/h]	\dot{V}_W [l/h]	$\dot{V}_n L$ [m³/h]
20°-30°	140.252.30.01	0.50	0.75	500	-	-	4.50	4.00	8.00	6.00	10.50	8.00
		0.50	0.75	200	4.50	2.50	7.00	4.00	10.00	6.00	12.00	8.00

Assembly scheme/Accessories

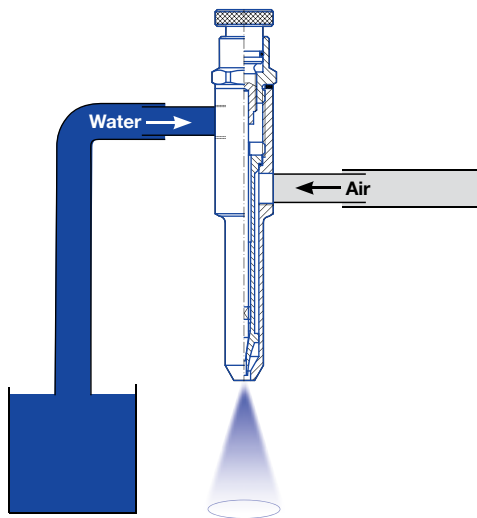

Accessories:

- Gasket
014.040.72
7.8 x 12 x 1 (EWP 210)
- Nipple
014.010.30.04
(Material: Brass)
Weight: 17 g

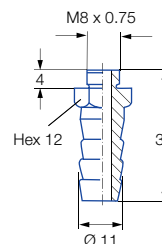

➤ Pneumatic atomizing nozzles for atomizing viscous media

Series 176 ViscoMist

The ViscoMist series enables the independent regulation of both atomizing air and fan air. Spray angle and droplet size can thus be individually adjusted.

The integrated, pneumatically controlled shut-off/clean-out needle opens and closes the liquid orifice and also cleans it during each closing procedure. This is of particular advantage when spraying viscous liquids. Thanks to their modular design, the nozzles of the ViscoMist series can be optimally adapted to the respective spraying process. To do this, it is simply enough to replace the nozzle components relevant for the flow rate and spray pattern. The housing stays the same.



Series 176 ViscoMist

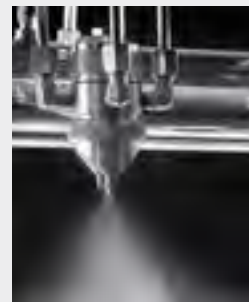
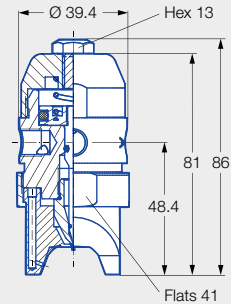
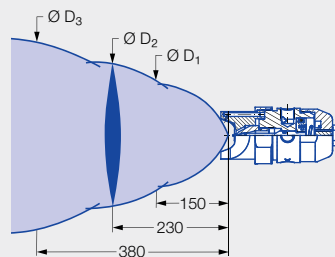

External mixing nozzle for viscous liquids, e.g. for:

- Coating processes
- Moisturising
- Lubrication
- Glazing
- Disinfection

One nozzle – several spray characters:

- Spray characters
 - Solid stream
 - Full cone
 - Flat fan
- Independent regulation of liquid, atomizing air and fan air
- Fluid circulation possible (nozzle body with five connections)

Nozzle sizes:

- Ø 0.38 mm to 2.54 mm

Valve position:

- Normally closed, fail-safe with loss of air

Signal air pressure:

- Min. 2 bar, max. 3 bar

Cycles per minute:

- 180 cycles/min (short term)

Connection thread:

- 1/8 BSPP
- NPT thread available on request

Weight:

- 550 g

Material:

- 1Y (stainless steel 316L)

Flow rate range:

- Water: 7.8 to 307.0 l/h, at 2 bar
- Air 7.5 to 28.4 m³/h in normal condition, at 2 bar

Atomizing air/Signal air/Fan air:

- The atomizing air causes the liquid to atomize at the nozzle orifice. The fan air allows the spray characteristics to be adapted to the application. The nozzle is activated by the signal air.

Nozzle body configurations

Nozzle body configuration 2

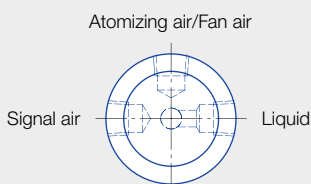

Version with three connections

Nozzle body configuration 4

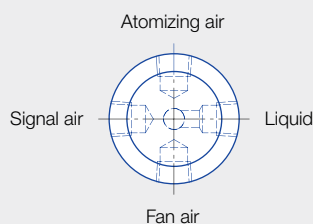

Version with four connections

Nozzle body configuration 5

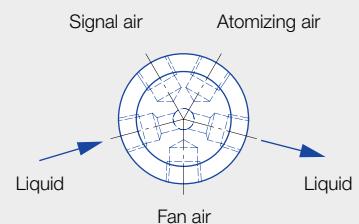

Version with five connections

Ordering no.	Narrowest free cross section Ø [mm]	Liquid		Air			Spray dimensions [mm] at distance D ₁ , D ₂ and D ₃																
		Liquid pressure p [bar]	V water [l/h]	Air pressure p air [bar]	Atomizing air [m ³ /h]	Fan air [m ³ /h]	Atomizing air [bar]	Liquid pressure p [bar]	Fan air [bar]														
									0.00*			0.35			0.70			1.00			1.50		
									Ø D ₁ = 150 mm	Ø D ₂ = 230 mm	Ø D ₃ = 380 mm	Ø D ₁ = 150 mm	Ø D ₂ = 230 mm	Ø D ₃ = 380 mm	Ø D ₁ = 150 mm	Ø D ₂ = 230 mm	Ø D ₃ = 380 mm	Ø D ₁ = 150 mm	Ø D ₂ = 230 mm	Ø D ₃ = 380 mm	Ø D ₁ = 150 mm	Ø D ₂ = 230 mm	Ø D ₃ = 380 mm
176.201.1Y.11.00 176.401.1Y.11.00 176.501.1Y.11.00	0.38	0.15	1.89	0.15	0.75	1.00	0.30	0.35	40	60	100	150	180	200	180	230	290	180	230	250	180	230	280
		0.30	2.80	0.30	1.09	1.44		0.70	40	50	80	150	200	280	200	270	330	230	280	330	230	280	330
		0.70	4.39	0.70	1.63	2.28		1.00	-	-	-	170	200	280	200	300	380	230	300	360	250	300	380
		1.00	5.49	1.00	2.02	2.89		1.50	-	-	-	170	200	360	200	250	340	250	300	360	280	320	380
		1.35	6.40	1.35	2.38	3.45	1.00	0.35	40	60	100	100	130	170	130	180	230	150	230	280	170	220	300
		1.70	7.19	1.70	2.77	3.99		0.70	40	60	100	80	110	180	130	180	230	150	200	230	180	230	280
		2.00	7.91	2.00	3.11	4.55		1.00	30	40	80	80	130	180	130	180	250	150	230	280	180	230	330
		2.40	8.63	2.40	3.48	5.11		1.50	-	-	-	100	150	200	150	190	250	180	250	360	190	270	360
		2.75	9.24	2.75	3.87	5.67	2.00	0.35	40	60	100	50	80	110	90	130	150	100	150	190	150	200	240
		3.15	9.80	3.15	4.23	6.24		0.70	40	60	90	60	90	140	80	100	140	110	180	230	150	200	250
		3.50	10.33	3.50	4.60	6.78		1.00	40	60	90	70	90	140	100	130	190	130	200	250	150	200	250
		4.00	11.17	4.00	5.22	7.70		1.50	-	-	-	60	80	130	110	140	180	140	190	230	180	230	300
176.202.1Y.11.00 176.402.1Y.11.00 176.502.1Y.11.00	0.58	0.15	4.05	0.15	0.78	1.00	0.30	0.35	40	60	100	140	190	270	220	250	300	190	240	280	200	230	300
		0.30	5.90	0.30	1.10	1.44		0.70	-	-	-	180	240	250	230	300	360	280	330	410	300	340	410
		0.70	9.27	0.70	1.67	2.28		1.00	-	-	-	150	200	230	250	290	430	300	340	460	300	370	560
		1.00	11.47	1.00	2.06	2.89		1.50	-	-	-	-	-	-	250	290	360	280	340	430	360	410	480
		1.35	13.32	1.35	2.43	3.45	1.00	0.35	40	50	90	110	140	150	130	170	230	150	180	230	180	220	250
		1.70	14.99	1.70	2.79	3.99		0.70	40	60	90	110	130	190	140	180	240	170	220	250	200	230	280
		2.00	16.43	2.00	3.14	4.55		1.00	-	-	-	100	140	200	170	200	280	190	230	330	200	250	330
		2.40	17.90	2.40	3.52	5.11		1.50	-	-	-	-	-	-	170	200	300	200	250	360	250	300	380
		2.75	19.23	2.75	3.91	5.67	2.00	0.35	40	50	80	60	80	110	90	130	170	110	150	180	130	200	230
		3.15	20.44	3.15	4.28	6.24		0.70	40	40	80	70	100	130	110	140	170	140	180	190	150	200	250
		3.50	21.57	3.50	4.66	6.78		1.00	30	50	90	70	100	130	100	150	180	130	180	230	150	200	250
		4.00	23.32	4.00	5.22	7.70		1.50	-	-	-	70	100	150	110	150	230	130	180	240	170	230	300
176.203.1Y.11.00 176.403.1Y.11.00 176.503.1Y.11.00	0.79	0.15	8.36	0.15	0.48	1.00	0.30	0.35	-	-	-	230	300	410	330	410	480	330	410	510	300	380	460
		0.30	12.38	0.30	0.71	1.44		0.70	-	-	-	230	280	330	300	360	510	410	480	610	430	580	740
		0.70	19.19	0.70	1.16	2.28		1.00	-	-	-	-	-	-	330	410	530	410	460	640	460	530	710
		1.00	23.77	1.00	1.46	2.89		1.50	-	-	-	-	-	-	280	360	460	380	460	610	410	510	580
		1.35	27.59	1.35	1.65	3.45	1.00	0.35	40	60	100	150	200	270	170	230	280	230	300	380	280	360	410
		1.70	31.04	1.70	1.89	3.99		0.70	-	-	-	150	200	250	230	300	380	300	360	460	330	380	430
								1.00	-	-	-	-	-	-	230	280	410	300	380	510	300	410	480
								1.50	-	-	-	-	-	-	230	280	380	280	380	510	330	430	530

* A cone-shaped spray pattern is produced without fan air.





Ordering no.	Narrowest free cross section Ø [mm]	Liquid		Air			Spray dimensions [mm] at distance D ₁ , D ₂ and D ₃																		
		Liquid pressure p [bar]	V water [l/h]	Air pressure p air [bar]	Atomizing air [m³/h]	Fan air [m³/h]	Atomizing air [bar]	Liquid pressure p [bar]	Fan air [bar]																
									0.00*			0.35			0.70			1.00			1.50				
									Ø D ₁ = 150 mm	Ø D ₂ = 230 mm	Ø D ₃ = 380 mm	Ø D ₁ = 150 mm	Ø D ₂ = 230 mm	Ø D ₃ = 380 mm	Ø D ₁ = 150 mm	Ø D ₂ = 230 mm	Ø D ₃ = 380 mm	Ø D ₁ = 150 mm	Ø D ₂ = 230 mm	Ø D ₃ = 380 mm	Ø D ₁ = 150 mm	Ø D ₂ = 230 mm	Ø D ₃ = 380 mm		
176.203.1Y.11.00 176.403.1Y.11.00 176.503.1Y.11.00	0.79	2.00	33.99	2.00	2.14	4.55	2.00	0.35	30	60	80	100	140	180	150	200	240	190	230	300	200	230	280		
		2.40	36.75	2.40	2.40	5.11		0.70	-	-	-	130	150	200	170	230	330	230	300	380	250	300	360		
		2.75	39.44	2.75	2.65	5.67		1.00	-	-	-	130	180	200	180	230	330	230	300	410	250	320	410		
		3.15	41.98	3.15	2.94	6.24		1.50	-	-	-	-	-	-	180	230	330	240	300	430	250	330	430		
		3.50	44.32	3.50	3.16	6.78	2.75	0.35	40	60	90	100	130	180	140	180	230	170	200	280	190	230	300		
		4.00	47.92	4.00	3.65	7.70		0.70	-	-	-	110	150	200	150	200	250	180	230	300	230	280	380		
								1.00	-	-	-	-	-	-	180	230	300	200	250	360	230	280	380		
176.204.1Y.11.00 176.404.1Y.11.00 176.504.1Y.11.00	1.07	0.15	16.88	0.15	2.34	2.04	0.30	0.35	-	-	-	150	200	300	300	410	460	330	410	560	300	410	510		
		0.30	24.38	0.30	3.47	2.94		0.70	-	-	-	-	-	-	300	380	1,040	360	430	530	410	480	640		
		0.70	37.28	0.70	5.59	4.60		1.00	-	-	-	-	-	-	250	380	510	360	460	580	410	510	690		
		1.00	45.80	1.00	7.32	5.81		1.50	-	-	-	-	-	-	250	380	480	330	380	530	410	510	660		
		1.35	52.91	1.35	8.83	6.90	1.00	0.35	40	60	80	110	140	190	150	200	250	200	250	330	250	300	430		
		1.70	59.20	1.70	10.19	7.99		0.70	-	-	-	100	140	230	170	200	270	220	270	380	250	330	430		
		2.00	64.99	2.00	11.55	9.06		1.00	-	-	-	100	130	180	150	190	300	220	250	380	250	300	480		
		2.40	70.55	2.40	12.91	10.13	2.00	1.50	-	-	-	-	-	-	150	200	280	200	250	410	240	300	460		
		2.75	75.51	2.75	14.31	11.21		0.35	40	60	90	80	100	140	100	130	180	110	170	230	150	190	280		
		3.15	80.28	3.15	15.63	12.27		0.70	-	-	-	80	100	150	100	130	200	130	170	230	150	200	280		
		3.50	84.90	3.50	17.11	13.32		1.00	-	-	-	70	100	150	100	140	200	130	180	250	150	200	280		
		4.00	91.56	4.00	19.49	15.12	1.50	-	-	-	70	100	150	110	140	230	130	170	250	150	200	300			
		176.205.1Y.11.00 176.405.1Y.11.00 176.505.1Y.11.00	1.32	0.15	24.60	0.15	2.17	2.04	0.30	0.35	-	-	-	230	330	460	360	460	530	410	530	640	460	530	660
				0.30	35.35	0.30	3.23	2.94		0.70	-	-	-	-	-	-	330	460	580	410	510	660	410	480	610
0.70	54.31			0.70	5.16	4.60	1.00	-		-	-	-	-	-	330	410	480	360	460	560	430	560	740		
1.00	66.62			1.00	6.75	5.81	1.50	-		-	-	-	-	-	-	-	-	380	510	660	460	580	810		
1.35	76.46			1.35	8.00	6.90	1.00	0.35	-	-	-	130	170	230	180	230	380	230	290	430	190	360	510		
1.70	86.18			1.70	9.17	7.99		0.70	-	-	-	110	170	230	180	230	330	220	290	410	190	360	510		
2.00	94.81			2.00	10.35	9.06		1.00	-	-	-	-	-	-	190	240	360	230	300	430	270	340	480		
2.40	102.95			2.40	11.55	10.13	2.00	1.50	-	-	-	-	-	-	170	220	300	220	300	410	250	330	480		
2.75	110.48			2.75	12.78	11.21		0.35	40	60	90	80	100	150	110	140	200	140	180	250	170	220	330		
3.15	117.52			3.15	14.00	12.27		0.70	-	-	-	70	100	150	110	150	230	130	180	280	170	230	360		
3.50	124.15			3.50	15.10	13.32		1.00	-	-	-	80	100	150	110	140	220	140	190	280	170	230	360		
4.00	134.14			4.00	17.23	15.12	1.50	-	-	-	70	100	150	110	150	200	140	190	300	170	230	360			
							2.75	0.35	40	60	100	80	100	150	90	130	200	110	150	230	140	180	280		
								0.70	-	-	-	60	90	140	100	130	200	110	170	250	150	200	300		
					1.00	-		-	-	60	90	130	100	130	200	120	170	240	150	200	300				
					1.50	-		-	-	60	90	150	100	130	200	110	180	250	150	200	300				

* A cone-shaped spray pattern is produced without fan air.

Ordering no.	Narrowest free cross section Ø [mm]	Liquid		Air			Spray dimensions [mm] at distance D ₁ , D ₂ and D ₃																																																								
		Liquid pressure p [bar]	V̇ water [l/h]	Air pressure p air [bar]	Atomizing air [m ³ /h]	Fan air [m ³ /h]	Atomizing air [bar]	Liquid pressure p [bar]	Fan air [bar]																																																						
									0.70			1.00			1.40			1.75			2.00																																										
									Ø D ₁ = 150 mm	Ø D ₂ = 230 mm	Ø D ₃ = 380 mm	Ø D ₁ = 150 mm	Ø D ₂ = 230 mm	Ø D ₃ = 380 mm	Ø D ₁ = 150 mm	Ø D ₂ = 230 mm	Ø D ₃ = 380 mm	Ø D ₁ = 150 mm	Ø D ₂ = 230 mm	Ø D ₃ = 380 mm	Ø D ₁ = 150 mm	Ø D ₂ = 230 mm	Ø D ₃ = 380 mm																																								
176.206.1Y.11.00 176.406.1Y.11.00 176.506.1Y.11.00	1,70	0.15	41.71	0.15	1.53	2.04	1.00	0.35	220	330	510	280	410	610	360	460	660	-	-	-	-	-	-																																								
		0.30	59.54	0.30	2.24	2.94		0.70	240	360	530	330	430	660	360	510	760	-	-	-	-	-	-																																								
		0.70	90.88	0.70	3.47	4.60		1.00	250	360	510	300	430	610	360	510	690	-	-	-	-	-	-																																								
		1.00	111.73	1.00	4.35	5.81		1.50	-	-	-	300	380	560	330	460	610	-	-	-	-	-	-																																								
		1.35	128.99	1.35	5.15	6.90	2.00	0.35	150	230	330	200	280	410	230	300	460	230	330	460	250	330	430																																								
		1.70	144.21	1.70	5.95	7.99		0.70	180	230	300	200	250	380	230	300	460	250	360	480	280	360	510																																								
		2.00	157.91	2.00	6.71	9.06		1.00	150	230	330	180	250	380	230	300	430	250	330	480	280	360	530																																								
		2.40	170.48	2.40	7.53	10.13		1.50	-	-	-	180	250	360	230	280	430	250	330	510	280	360	510																																								
		2.75	182.25	2.75	8.27	11.21	2.75	0.35	140	180	280	180	230	300	180	250	360	200	280	410	200	280	430																																								
		3.15	193.26	3.15	9.07	12.27		0.70	150	200	300	180	230	330	180	250	380	200	280	410	230	300	410																																								
		3.50	203.52	3.50	9.91	13.32		1.00	140	180	280	180	230	330	190	230	380	200	280	410	230	300	430																																								
		4.00	218.85	4.00	11.13	15.12		1.50	130	180	250	150	200	330	180	250	380	200	280	430	230	330	480																																								
		176.207.1Y.11.00 176.407.1Y.11.00 176.507.1Y.11.00	2,05	0.15	59.20	0.15	3.64	3.36	1.00	0.35	200	280	410	280	360	480	330	430	530	330	480	690	410	480	660																																						
				0.30	84.97	0.30	5.37	4.91		0.70	200	280	410	280	360	480	300	410	580	360	460	710	410	530	760																																						
				0.70	129.79	0.70	8.53	7.87		1.00	150	230	360	230	300	460	280	360	530	300	430	610	360	510	740																																						
				1.00	159.42	1.00	10.84	10.08		1.50	-	-	-	-	-	-	-	-	-	-	-	-	-	-	-																																						
1.35	184.59			1.35	12.98	12.16	2.00	0.35	100	140	220	140	190	280	180	230	360	230	280	380	250	330	480																																								
1.70	206.70			1.70	14.92	14.07		0.70	100	150	230	140	190	280	180	250	380	200	280	410	250	330	480																																								
2.00	226.76			2.00	16.91	15.97		1.00	100	150	250	130	180	280	170	220	330	200	280	410	240	300	480																																								
2.40	245.27			2.40	18.94	17.69		1.50	-	-	-	-	-	-	150	230	330	190	250	380	230	300	430																																								
2.75	262.64			2.75	20.86	19.64	2.75	0.35	90	130	180	110	170	250	150	200	300	180	230	330	200	280	380																																								
3.15	279.03			3.15	22.82	21.53		0.70	90	130	200	130	170	250	150	200	300	180	230	360	200	280	410																																								
3.50	293.98			3.50	24.72	23.33		1.00	90	110	180	120	150	250	140	190	300	170	230	330	200	280	380																																								
4.00	317.15			4.00	27.80	26.33		1.50	90	130	200	110	150	250	140	200	300	150	230	360	200	280	380																																								





Ordering no.	Narrowest free cross section Ø [mm]	Liquid		Air			Spray dimensions [mm] at distance D ₁ , D ₂ and D ₃																		
		Liquid pressure p [bar]	V̇ water [l/h]	Air pressure p air [bar]	Atomizing air [m ³ /h]	Fan air [m ³ /h]	Atomizing air [bar]	Liquid pressure p [bar]	Fan air [bar]																
									0.70			1.00			1.40			1.75			2.00				
									Ø D ₁ = 150 mm	Ø D ₂ = 230 mm	Ø D ₃ = 380 mm	Ø D ₁ = 150 mm	Ø D ₂ = 230 mm	Ø D ₃ = 380 mm	Ø D ₁ = 150 mm	Ø D ₂ = 230 mm	Ø D ₃ = 380 mm	Ø D ₁ = 150 mm	Ø D ₂ = 230 mm	Ø D ₃ = 380 mm	Ø D ₁ = 150 mm	Ø D ₂ = 230 mm	Ø D ₃ = 380 mm		
176.208.1Y.11.00 176.408.1Y.11.00 176.508.1Y.11.00	2.36	0.15	97.20	0.15	3.84	4.40	1.00	0.35	190	280	430	280	360	610	300	460	710	-	-	-	-	-	-		
		0.30	114.76	0.30	4.64	5.28		0.70	190	280	430	250	360	610	330	480	760	-	-	-	-	-	-		
		0.70	162.98	0.70	6.80	7.87		1.00	-	-	-	230	330	560	300	430	690	-	-	-	-	-	-		
		1.00	199.13	1.00	8.63	10.08		1.50	-	-	-	250	360	530	300	380	580	-	-	-	-	-	-		
		1.35	229.60	1.35	10.21	12.16	2.00	0.35	110	190	300	170	250	360	200	280	410	230	330	460	280	460	560		
		1.70	256.24	1.70	11.86	14.07		0.70	110	180	250	170	230	360	220	280	410	230	360	510	270	380	530		
		2.00	280.70	2.00	13.37	15.97		1.00	110	170	230	140	200	330	190	250	410	230	300	480	280	380	610		
		2.40	302.99	2.40	14.99	17.69		1.50	-	-	-	150	200	330	200	280	380	220	300	460	270	380	560		
		2.75	324.03	2.75	16.33	19.64	2.75	0.35	110	170	230	140	190	280	170	250	360	200	280	380	250	360	460		
		3.15	343.22	3.15	17.99	21.53		0.70	100	150	230	140	200	300	170	240	360	200	280	430	230	330	480		
		3.50	361.32	3.50	19.27	23.33		1.00	100	140	200	130	180	280	170	230	380	200	280	410	230	330	480		
		4.00	388.72	4.00	21.73	26.33		1.50	90	130	200	130	180	280	150	220	360	190	280	460	230	320	460		
		176.209.1Y.11.00 176.409.1Y.11.00 176.509.1Y.11.00	2.54	0.15	82.06	0.15	1.87	3.36	1.00	0.35	200	300	460	280	380	610	330	460	710	410	530	760	460	660	810
				0.30	119.53	0.30	3.77	4.91		0.70	200	280	430	280	410	610	330	480	690	410	560	740	460	640	810
0.69	180.05			0.69	6.58	7.87	1.00	-		-	-	-	-	-	300	460	690	410	510	690	430	580	810		
1.03	221.23			1.03	8.50	10.08	1.50	-		-	-	-	-	-	300	460	690	380	530	760	430	580	810		
1.38	255.60			1.38	10.13	12.16	2.00	0.35	130	200	300	180	250	380	200	280	460	250	330	510	280	360	560		
1.72	285.50			1.72	11.57	14.07		0.70	130	180	280	170	230	360	200	280	460	230	330	560	280	380	610		
2.07	312.94			2.07	13.13	15.97		1.00	100	170	280	170	230	360	200	280	430	230	330	510	280	380	560		
2.41	338.83			2.41	14.71	17.69		1.50	-	-	-	-	-	-	200	250	430	230	300	460	250	380	560		
2.76	362.49			2.76	16.26	19.64	2.75	0.35	100	150	230	150	200	330	170	230	410	200	280	460	240	360	510		
3.10	384.75			3.10	17.75	21.53		0.70	100	150	230	140	190	300	180	240	410	200	280	460	230	360	560		
3.45	405.71			3.45	19.33	23.33		1.00	90	140	230	140	190	300	180	250	410	200	280	460	250	360	560		
4.00	436.86			4.00	21.83	26.33		1.50	100	140	200	140	190	300	180	250	410	200	280	460	230	330	510		
176.209.1Y.11.00 176.409.1Y.11.00 176.509.1Y.11.00	2.54			3.10	384.75	3.10	17.75	21.53	4.00	0.35	100	140	200	130	180	250	140	190	280	180	250	360	190	250	410
				3.45	405.71	3.45	19.33	23.33		0.70	90	130	200	130	180	280	150	200	300	170	230	360	200	280	410
		4.00	436.86	4.00	21.83	26.33	1.00	90		130	180	110	150	250	140	200	300	180	230	410	200	280	460		
							1.50	-		-	-	110	150	250	140	180	300	170	230	410	190	280	460		

Notice:

The fourth digit in the order number (2, 4 or 5) stands for the housing variant (for details see Page 54).

➤ Spare parts set for pneumatic atomizing nozzles Series 176 ViscoMist

Overview of the spare parts set and the power set

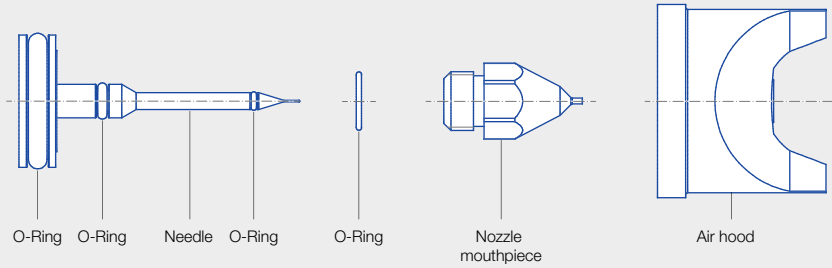

Spare parts set

Spare parts set for replacing the main wear parts of the nozzle, consisting of:

- Needle (stainless steel 316L)
- O-rings (Viton)
- Nozzle tip (stainless steel 316L)

Ordering no.	Narrowest free cross section Ø [mm]	For nozzles
Type		
017.601.1Y.01	0.38	176.xx1.1Y.11.00
017.602.1Y.01	0.58	176.xx2.1Y.11.00
017.603.1Y.01	0.79	176.xx3.1Y.11.00
017.604.1Y.01	1.07	176.xx4.1Y.11.00
017.605.1Y.01	1.32	176.xx5.1Y.11.00
017.606.1Y.01	1.32	176.xx6.1Y.11.00
017.607.1Y.01	2.05	176.xx7.1Y.11.00
017.608.1Y.01	2.36	176.xx8.1Y.11.00
017.609.1Y.01	2.54	176.xx9.1Y.11.00

Power set

Power set for replacing the main wear parts of the nozzle and the air hood, consisting of:

- Needle (stainless steel 316L)
- O-rings (Viton)
- Nozzle tip (stainless steel 316L)
- Air hood (stainless steel 316L)

Ordering no.	Narrowest free cross section Ø [mm]	For nozzles
Type		
017.601.1Y.00	0.38	176.xx1.1Y.11.00
017.602.1Y.00	0.58	176.xx2.1Y.11.00
017.603.1Y.00	0.79	176.xx3.1Y.11.00
017.604.1Y.00	1.07	176.xx4.1Y.11.00
017.605.1Y.00	1.32	176.xx5.1Y.11.00
017.606.1Y.00	1.32	176.xx6.1Y.11.00
017.607.1Y.00	2.05	176.xx7.1Y.11.00
017.608.1Y.00	2.36	176.xx8.1Y.11.00
017.609.1Y.00	2.54	176.xx9.1Y.11.00

Notice:

Instructions for replacing individual or all components of the nozzles are included in the scope of delivery of the spare parts sets and the power sets.

O-ring set

Ordering no.		Consisting of 4 O-rings, suitable for all nozzles of series 176
Type	Mat. no.	
	7A	
	Viton	EPDM
017.600.xx.01.03	●	●

Viton (7A) is the standard O-ring material.
EPDM (6C) is optionally available.

Ordering Type + Material no. = Ordering no.
example: 017.600.xx.01.03 + 7A = 017.600.7A.01.03



➤➤ HOLLOW CONE NOZZLES

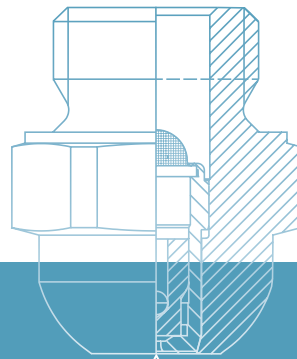

HOLLOW CONE NOZZLES OVERVIEW OF TYPES

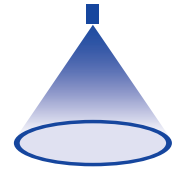

Hollow cone nozzles are used wherever fine droplets are required. A distinction is made between axial-flow hollow cone nozzles and tangential-flow hollow cone nozzles. Axial-flow hollow cone nozzles are mainly used for cooling, humidification and disinfecting, whilst tangential-flow hollow cone nozzles are traditionally used for humidification of air, dust control, sprinkling and foaming.

Axial-flow hollow cone nozzles



- High and controlled degree of atomization due to integrated swirl insert
- Narrow droplet spectrum
- Uniform atomization
- Large droplet surface area for mass transfer processes

Tangential-flow hollow cone nozzles









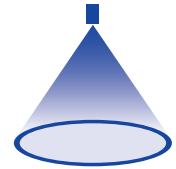

- Liquid rotation without swirl insert
- Maximum free passage making less susceptible to clogging
- Large free cross sections
- Operational reliability
- Coarse droplets that are larger than axial-flow hollow cone nozzles









Hollow cone
nozzles

HOLLOW CONE NOZZLES OVERVIEW OF SERIES

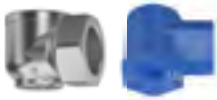

		Axial-flow hollow cone nozzles			
					
Series		220	226	214/216	2TR
Information on page		66	67	68	69
 Flow rate at p = 2 bar	Very low < 0.5 l/min	• (at p = 5 bar)	• (at p = 5 bar)	• (at p = 5 bar)	• (at p = 5 bar)
	Low 0.5 l/min–2.0 l/min			• (at p = 5 bar)	• (at p = 5 bar)
	Medium 2.0 l/min–10.0 l/min			• (at p = 5 bar)	
	High 10.0 l/min–50.0 l/min			• (at p = 5 bar)	
	Very high > 50.0 l/min				
 Spray angle	Small 45°				
	Medium 55°–95°	•	•	•	•
	Large 130°				
 Nozzle material	Stainless steel	•	•	•	
	Brass			•	
	Plastic				•
 Nozzle connection		1/4 BSPP	Assembly with retaining nut 3/8 BSPP	1/8 BSPP 3/8 BSPP	Assembly with retaining nut 3/8 BSPP

Tangential-flow hollow cone nozzles

					
302	302 with bayonet quick-release system	308	304/306/307	350	373 Ramp Bottom
70/71	66	74	75	76	77
•	•				
•	•	•		•	
•		•	•	•	
•			•		
					•
	•				
•	•	•	•		•
•	•		•	•	
•			•		•
•		•	•		
•	•			•	
3/8 BSPP	Assembly with bayonet quick-release system	3/8 BSPP	1/2 BSPP 3/4 BSPP	3/8 BSPP quick-release system	1 BSPP 1 1/4 BSPP 1 1/2 BSPP

➤ Axial-flow hollow cone nozzles Series 220

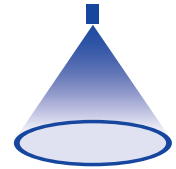

Features:

- Extremely fine, fog-like atomization

Applications:

- Humidification
- Cooling
- Disinfection
- Chemical engineering
- Adiabatic cooling

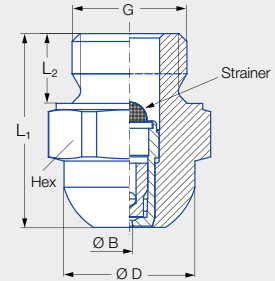

Series 220

Code	G	Dimensions [mm]				Weight [g]
		L ₁	L ₂	Ø D	Hex	
AC	1/4 BSPP	22.0	8.0	15.0	17	27.0

Spray angle	Ordering no.			Bore diameter B [mm]	Narrowest free cross section Ø [mm]	Strainer insert mesh size [mm]	V̇ water [l/min]								Spray diameter D [mm] (at p = 5 bar)	
	Type	Mat. no.					Code	p [bar]								
		1Y	11													
		Stainless steel 316L	Stainless steel 430F													
			1/4 BSPP				2.0	3.0	5.0	7.0	10.0	20.0	50.0	100.0	H = 250 [mm]	
60°	220.004	●	●	AC	0.10	0.10	0.04	–	–	0.013	0.015	0.018	0.026	0.041	0.058	120
	220.014	●	●	AC	0.15	0.15	0.04	–	0.015	0.019	0.022	0.027	0.038	0.060	0.085	140
	220.054	●	●	AC	0.20	0.15	0.04	0.017	0.021	0.027	0.032	0.038	0.054	0.085	0.121	160
80°	220.085	●	●	AC	0.25	0.25	0.10	0.025	0.031	0.040	0.047	0.057	0.080	0.126	0.179	190
	220.125	●	●	AC	0.35	0.35	0.10	0.039	0.048	0.062	0.073	0.088	0.124	0.196	0.277	230
	220.145	●	●	AC	0.40	0.40	0.10	0.052	0.064	0.082	0.097	0.116	0.164	0.259	0.367	250
	220.165	●	●	AC	0.45	0.45	0.10	0.065	0.080	0.103	0.122	0.146	0.206	0.326	0.461	260
	220.185	●	●	AC	0.55	0.35	0.20	0.082	0.101	0.130	0.154	0.184	0.260	0.411	0.581	270
	220.205	●	●	AC	0.60	0.35	0.20	0.106	0.130	0.168	0.199	0.238	0.336	0.531	0.751	280
	220.245	●	●	AC	0.70	0.50	0.20	0.165	0.202	0.261	0.309	0.369	0.522	0.825	1.167	290
220.285	●	●	AC	0.90	0.55	0.20	0.247	0.302	0.390	0.461	0.552	0.780	1.233	1.744	300	

Mat. no.	Housing	Nozzle insert	Strainer
1Y	Stainless steel 316L	Stainless steel 316L	Stainless steel 316L
11	Stainless steel 430F	Stainless steel 430F	Stainless steel 316L

The supplied and integrated strainer insert prevents clogging of the nozzle, thereby ensuring a long service life.

Conversion formula for this series: $\dot{V}_2 = \dot{V}_1 \cdot \sqrt{\frac{p_2}{p_1}}$

Ordering Type + Material no. + Code = Ordering no.
example: 220.004 + 1Y + AC = 220.004.1Y.AC

 Assembly accessories can be found in Chapter 9 "Accessories".

➤ Axial-flow hollow cone nozzles Series 226

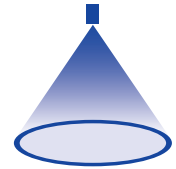

Features:

- Extremely fine, fog-like atomization
- Assembly with retaining nut

Applications:

- Humidification
- Cooling
- Disinfection
- Chemical engineering
- Adiabatic cooling

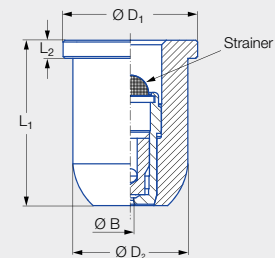

Series 226

Code	Dimensions [mm]				Weight [g]
	L ₁	L ₂	Ø D ₁	Ø D ₂	
Assembly with retaining nut 3/8 BSPP	18.00	2.00	14.80	12.65	20.00

Spray angle	Ordering no.		Bore diameter B [mm]	Narrowest free cross section Ø [mm]	Strainer insert mesh size [mm]	V̇ water [l/min]								Spray diameter D [mm] (at p = 5 bar)	
	Type	Mat. no.				p [bar]									
		16				2.0	3.0	5.0	7.0	10.0	20.0	50.0	100.0		
60°	Stainless steel 303	226.004	●	0.10	0.10	0.04	–	–	0.013	0.015	0.018	0.026	0.041	0.058	120
		226.014	●	0.15	0.15	0.04	–	0.015	0.019	0.022	0.027	0.038	0.060	0.085	140
		226.054	●	0.20	0.15	0.04	0.017	0.021	0.027	0.032	0.038	0.054	0.085	0.121	160
80°	Stainless steel 303	226.085	●	0.25	0.25	0.10	0.025	0.031	0.040	0.047	0.057	0.080	0.126	0.179	190
		226.125	●	0.35	0.35	0.10	0.039	0.048	0.062	0.073	0.088	0.124	0.196	0.277	230
		226.145	●	0.40	0.40	0.10	0.052	0.064	0.082	0.097	0.116	0.164	0.259	0.367	250
		226.165	●	0.45	0.45	0.10	0.065	0.080	0.103	0.122	0.146	0.206	0.326	0.461	260
		226.185	●	0.55	0.35	0.20	0.082	0.101	0.130	0.154	0.184	0.260	0.411	0.581	270
		226.205	●	0.60	0.35	0.20	0.106	0.130	0.168	0.199	0.238	0.336	0.531	0.751	280
		226.245	●	0.70	0.50	0.20	0.165	0.202	0.261	0.309	0.369	0.522	0.825	1.167	290
226.285	●	0.90	0.55	0.20	0.247	0.302	0.390	0.461	0.552	0.780	1.233	1.744	300		

Mat. no.	Housing	Nozzle insert	Strainer
16	Stainless steel 303	Stainless steel 430F	Stainless steel 316L

The supplied and integrated strainer insert prevents clogging of the nozzle, thereby ensuring a long service life.

Conversion formula for this series: $\dot{V}_2 = \dot{V}_1 \cdot \sqrt{\frac{P_2}{P_1}}$

Ordering Type + Material no. = Ordering no.
example: 226.004 + 16 = 226.004.16

Assembly accessories can be found in Chapter 9 "Accessories".

➤ Axial-flow hollow cone nozzles Series 214/216

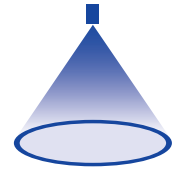

Features:

- Fine, uniform atomization

Applications:

- Cooling
- Gas washing
- Dust control
- Sprinkling
- Adiabatic cooling

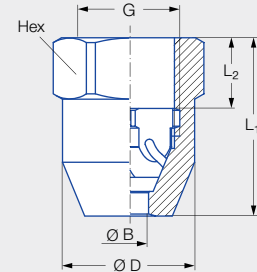

Series 214/216

Series	G	Dimensions [mm]				Weight [g] (Brass)
		L ₁	L ₂	Ø D	Hex	
214	1/8 BSPP	18.0	6.0	16.0	17	27.0
216	3/8 BSPP	29.0	12.0	21.3	22	60.0

Spray angle	Ordering no.			Bore diameter B [mm]	Narrowest free cross section Ø [mm]	V̇ water [l/min]							Spray diameter D [mm] (at p = 5 bar)
	Type	Mat. no.				p [bar]							
		17	30			0.5	1.0	2.0	3.0	5.0	10.0	20.0	
60°	214.184	●	●	0.50	0.50	–	–	0.08	0.10	0.13	0.18	0.25	120
	216.324	●	●	1.00	1.00	–	0.28	0.40	0.49	0.63	0.89	1.26	190
	216.364	●	●	1.40	1.40	–	0.45	0.63	0.77	1.00	1.41	1.99	220
	216.404	●	●	2.00	2.00	–	0.71	1.00	1.22	1.58	2.24	3.16	240
80°	214.245	●	●	1.00	0.50	–	–	0.16	0.20	0.25	0.36	0.51	240
	214.305	●	●	1.80	0.50	–	0.23	0.32	0.39	0.51	0.72	1.01	320
90°	216.496	●	●	3.00	2.00	–	1.20	1.70	2.08	2.69	3.80	5.38	430
	216.566	●	●	4.00	2.00	–	1.77	2.50	3.06	3.95	5.59	7.91	430
	216.646	●	●	3.50	2.00	2.00	2.83	4.00	4.90	6.32	8.94	12.65	440
	216.686	●	●	4.00	2.00	2.50	3.54	5.00	6.12	7.91	11.18	15.81	450
	216.726	●	●	5.00	2.00	3.15	4.45	6.30	7.72	9.96	14.09	19.92	460
	216.776	●	●	6.00	2.00	4.30	6.00	8.50	10.40	13.40	19.00	26.90	470

Conversion formula for this series: $\dot{V}_2 = \dot{V}_1 \cdot \sqrt{\frac{p_2}{p_1}}$

Ordering Type + Material no. = Ordering no.
example: 214.184 + 17 = 214.184.17

 Assembly accessories can be found in Chapter 9 "Accessories".

➤ Axial-flow hollow cone nozzles Series 2TR

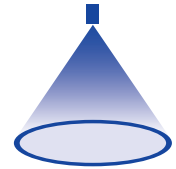

Features:

- Fine, uniform atomization
- Assembly with retaining nut

Applications:

- Sprinkling
- Adiabatic cooling
- Cooling
- Humidification of air

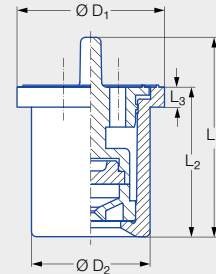

Series 2TR

Code	Dimensions [mm]					Weight [g]
	L ₁	L ₂	L ₃	Ø D ₁	Ø D ₂	
Assembly with retaining nut 3/8 BSPP	20.0	15.0	2.0	14.8	11.9	3.0

Spray angle	Ordering no.		Color	Bore diameter B [mm]	Narrowest free cross section Ø [mm]	V̇ water [l/min]						Spray diameter D [mm] (at p = 5 bar)
	Type	Mat. no.				p [bar]						
		C8				1.0	2.0	3.0	5.0	7.0	10.0	
		Housing: POM Insert: Ceramic										H = 250 [mm]
80°	2TR.245	●	Purple	0.65	0.55	–	0.16	0.20	0.25	0.30	0.36	220
	2TR.275	●	Black	0.80	0.70	0.16	0.22	0.27	0.35	0.41	0.49	260
	2TR.305	●	Orange	0.90	0.80	0.23	0.32	0.39	0.51	0.60	0.72	320
	2TR.345	●	Green	1.10	0.90	0.34	0.48	0.59	0.76	0.90	1.07	420
	2TR.365	●	Yellow	1.40	0.95	0.46	0.65	0.80	1.03	1.22	1.45	490
	2TR.405	●	Blue	1.70	1.10	0.69	0.97	1.19	1.53	1.81	2.17	530
	2TR.445	●	Red	2.00	1.20	0.89	1.26	1.55	2.02	2.37	2.83	550
	2TR.485	●	Brown	2.20	1.30	1.11	1.57	1.94	2.50	2.96	3.54	560

Assembly example



Conversion formula for this series: $\dot{V}_2 = \dot{V}_1 \cdot \sqrt{\frac{p_2}{p_1}}$

Ordering Type + Material no. = Ordering no.
example: 2TR.245 + C8 = 2TR.245.C8

Assembly accessories can be found in Chapter 9 "Accessories".

➤ Tangential-flow hollow cone nozzles, stainless steel/brass version Series 302

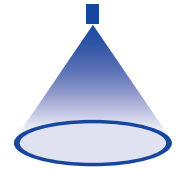

Features:

- Uniform atomization
- Non-clogging nozzle without swirl insert

Applications:

- Humidification of air
- Dust control
- Sprinkling
- Foam control
- Adiabatic cooling



Series 302

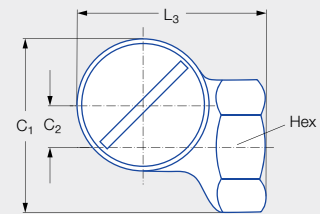
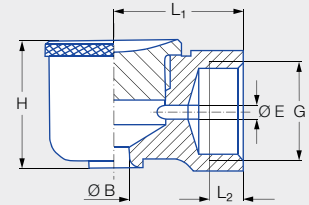

G	Dimensions [mm]							Weight [g] (Brass)
	C ₁	C ₂	H	L ₁	L ₂	L ₃	Hex	
3/8 BSPP	34.0	8.0	23.0	23.0	6.5	36.0	22	90.0

Spray angle	Ordering no.		Bore diameter B [mm]	Narrowest free cross section Ø [mm]	V̇ water [l/min]								Spray diameter D [mm] (at p = 2 bar)		
	Type	Mat. no.			p [bar]								H = 250 [mm]	H = 500 [mm]	
		1Y			30	0.5	1.0	2.0	3.0	5.0	7.0	10.0			
60°	302.364	•	•	1.50	1.50	0.32	0.45	0.63	0.77	1.00	1.18	1.41	280	420	
	302.464	•	•	2.00	2.00	0.70	0.99	1.40	1.71	2.21	2.62	3.13	280	460	
80°	302.545	•	•	4.90	2.30	1.12	1.58	2.24	2.74	3.54	4.19	5.01	360	660	
90°	302.606	•	•	4.60	4.00	1.58	2.23	3.15	3.86	4.98	5.89	7.04	470	810	
130°	302.368	•	•	3.00	1.00	0.32	0.45	0.63	0.77	1.00	1.18	1.41	660	1,080	
	302.468	•	•	5.00	1.70	0.70	0.99	1.40	1.71	2.21	2.62	3.13	810	1,370	
	302.548	•	•	5.00	2.50	1.12	1.58	2.24	2.74	3.54	4.19	5.01	960	1,640	
	302.608	•	•	5.00	3.50	1.58	2.23	3.15	3.86	4.98	5.89	7.04	1,060	1,800	
	302.668	•	•	7.50	3.60	2.25	3.18	4.50	5.51	7.12	8.42	10.06	1,120	1,950	
	302.748	•	•	7.50	4.80	3.55	5.02	7.10	8.70	11.23	13.28	15.88	1,160	2,150	

Conversion formula for this series: $\dot{V}_2 = \dot{V}_1 \cdot \sqrt{\frac{p_2}{p_1}}$

Ordering Type + Material no. = Ordering no.
example: 302.364 + 30 = 302.364.30

 Assembly accessories can be found in Chapter 9 "Accessories".

➤ Tangential-flow hollow cone nozzles, plastic version

Series 302

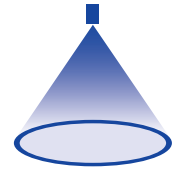

Features:

- Uniform atomization
- Non-clogging nozzle without swirl insert

Applications:

- Humidification of air
- Dust control
- Sprinkling
- Foam control
- Adiabatic cooling



Series 302

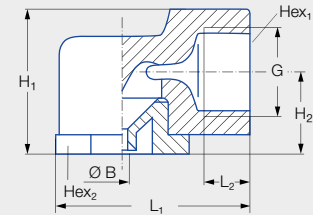

Type 302.32x-302.48x

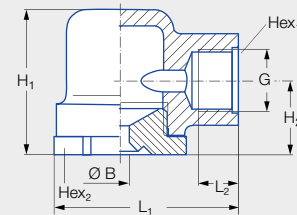

Type 302.52x-302.96x

Type	G	Dimensions [mm]						Weight [g]	p _{max} [bar]
		H ₁	H ₂	L ₁	L ₂	Hex ₁	Hex ₂		
302.32x-302.48x	3/8 BSPP	27.5	16.5	43.5	10.0	22	22	13.0	5.0
302.52x-302.96x	3/8 BSPP	34.0	18.5	37.0	10.0	22	22	18.0	5.0

Spray angle	Ordering no.			Bore diameter B [mm]	Narrowest free cross section Ø [mm]	V̇ water [l/min]					Spray diameter D [mm] (at p = 2 bar)		
	Type	Mat. no.				p [bar]					 H = 250 [mm] H = 500 [mm]		
		51	5E			53	0.5	1.0	2.0	3.0			5.0
60°	302.364	●		●	1.30	1.30	0.32	0.45	0.63	0.77	1.00	320	600
	302.464	●		●	1.95	1.95	0.70	0.99	1.40	1.71	2.21	330	620
90°	302.326	●	●		1.05	1.05	0.20	0.28	0.40	0.49	0.63	470	770
	302.366	●	●		1.30	1.30	0.32	0.45	0.63	0.77	1.00	480	790
	302.406	●	●	●	1.55	1.55	0.50	0.71	1.00	1.22	1.58	490	810
	302.486	●		●	2.10	2.10	0.80	1.13	1.60	1.96	2.53	510	850
	302.526	●		●	5.00	2.00	1.00	1.41	2.00	2.45	3.16	520	870
	302.566	●		●	5.00	2.40	1.25	1.77	2.50	3.06	3.95	520	900
	302.606	●		●	5.00	3.20	1.58	2.23	3.15	3.86	4.98	530	940
	302.686	●			7.50	3.40	2.50	3.54	5.00	6.12	7.91	540	1,010
	302.766	●			9.00	4.30	4.00	5.66	8.00	9.80	12.65	540	1,040
	302.846	●		●	11.00	5.20	6.25	8.84	12.50	15.31	19.67	540	1,050
	302.886	●	●	●	11.00	6.40	8.00	11.31	16.00	19.60	25.30	540	1,050
302.966	●			11.00	8.60	12.50	17.68	25.00	30.62	39.53	540	1,050	





Spray angle	Ordering no.			Bore diameter B [mm]	Narrowest free cross section Ø [mm]	V̇ water [l/min]					Spray diameter D [mm] (at p = 2 bar)		
	Type	Mat. no.				p [bar]							
		51	5E										53
		PA	PVDF			PP	0.5	1.0	2.0	3.0	5.0	H = 250 [mm]	H = 500 [mm]
130°	302.328		●		1.35	0.80	0.20	0.28	0.40	0.49	0.63	640	930
	302.368	●	●		1.85	1.10	0.32	0.45	0.63	0.77	1.00	660	1,010
	302.408	●	●		3.65	1.30	0.50	0.71	1.00	1.22	1.58	680	1,110
	302.488	●		●	5.20	1.60	0.80	1.13	1.60	1.96	2.53	720	1,250
	302.528	●			5.00	2.00	1.00	1.41	2.00	2.45	3.16	750	1,330
	302.568	●			5.00	2.40	1.25	1.77	2.50	3.06	3.95	780	1,410
	302.608	●	●	●	5.00	3.20	1.58	2.23	3.15	3.86	4.98	820	1,500
	302.648	●			7.50	3.00	2.00	2.83	4.00	4.90	6.32	860	1,590
	302.688	●			7.50	3.40	2.50	3.54	5.00	6.12	7.91	900	1,650
	302.728	●			7.50	4.10	3.15	4.45	6.30	7.72	9.96	920	1,700
	302.768	●			9.00	4.30	4.00	5.66	8.00	9.80	12.65	940	1,730
	302.848	●			11.00	5.20	6.25	8.84	12.50	15.31	19.76	960	1,760
	302.888	●		●	11.00	6.40	8.00	11.31	16.00	19.60	25.30	970	1,780
302.968	●	●		11.00	8.60	12.50	17.68	25.00	30.62	39.53	1000	1,800	

Conversion formula for this series: $\dot{V}_2 = \dot{V}_1 \cdot \sqrt{\frac{p_2}{p_1}}$

Ordering Type + Material no. = Ordering no.
 example: 302.328 + 5E = 302.328.5E



Assembly accessories can be found in Chapter 9 "Accessories".

➤ Tangential-flow hollow cone nozzles, plastic version with bayonet quick-release system Series 302

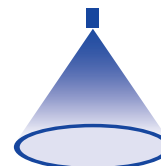

Features:

- Uniform atomization
- Non-clogging nozzle without swirl insert
- Quick and secure assembly thanks to bayonet quick-release system
- Setting of spray direction



Applications:

- Humidification of air
- Dust control
- Sprinkling
- Foam control
- Adiabatic cooling

Series 302

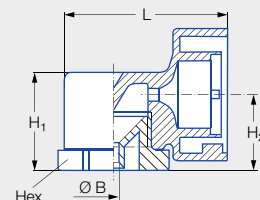

Type 302.32x-302.54x

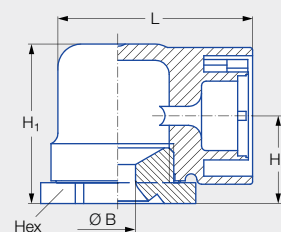

Type 302.606.51.KB

Type	Code	Dimensions [mm]				Weight [g]	P _{max} [bar]
		H ₁	H ₂	L	Hex		
302.32x-302.54x	KB	21.8	16.8	36.0	22	12.0	5.0
302.606.51.KB	KB	34.0	19.0	42.0	30	19.0	5.0

Spray angle	Ordering no.				Bore diameter B [mm]	Narrowest free cross section Ø [mm]	V̇ water [l/min]					Spray diameter D [mm] (at p = 2 bar)	
	Type	Mat. no.		Code			p [bar]					H = 250 [mm]	H = 500 [mm]
		51	56				0.5	1.0	2.0	3.0	5.0		
45°	302.503	●		KB	2.05	2.05	0.90	1.27	1.80	2.20	2.85	210	430
60°	302.464		●	KB	1.95	1.95	0.70	0.99	1.40	1.71	2.21	290	540
80°	302.545		●	KB	2.30	2.30	1.12	1.58	2.24	2.74	3.54	450	810
90°	302.326	●	●	KB	1.05	1.05	0.20	0.28	0.40	0.49	0.63	400	720
	302.406	●	●	KB	1.55	1.55	0.50	0.71	1.00	1.22	1.58	400	740
	302.486	●		KB	2.10	2.10	0.80	1.13	1.60	1.96	2.53	450	800
	302.606	●		KB	5.00	3.20	1.58	2.23	3.15	3.86	4.98	530	1,000
	302.686		●	KB	7.50	3.40	2.50	3.54	5.00	6.13	7.91	540	1,010
130°	302.368		●	KB	1.30	1.30	0.32	0.45	0.63	0.77	1.00	660	1,100
	302.408	●	●	KB	2.00	2.00	0.50	0.71	1.00	1.22	1.58	680	1,200
	302.468	●		KB	2.40	2.40	0.70	0.99	1.40	1.71	2.21	680	1,250
	302.488	●		KB	2.75	2.75	0.80	1.13	1.60	1.96	2.53	720	1,300

Conversion formula for this series: $\dot{V}_2 = \dot{V}_1 \cdot \sqrt{\frac{P_2}{P_1}}$

Ordering Type + Material no. + Code = Ordering no.
example: 302.503 + 51 + KB = 302.503.51.KB

Assembly accessories can be found in Chapter 9 "Accessories".

➤ Tangential-flow hollow cone nozzles Series 308

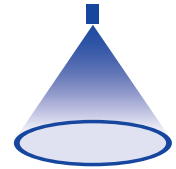

Features:

- Uniform atomization
- Non-clogging nozzle without swirl insert
- Adjustable flow rate

Applications:

- Humidification of air in air washers
- Dust control
- Spraying onto filters
- Foam control
- Cooling



Series 308

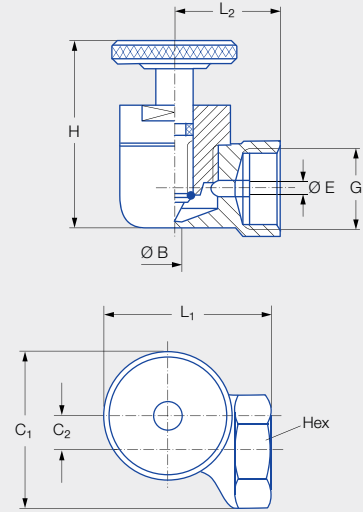

G	Dimensions [mm]						Weight [g]
	C ₁	C ₂	H	L ₁	L ₂	Hex	
3/8 BSPP	34.0	8.0	40.0	36.0	23.0	22	150.0

Spray angle	Ordering no.		Bore diameter B [mm]	Narrowest free cross section Ø [mm]	V _{max} water [l/min]						Spray diameter D [mm] (at p = 2 bar)	
	Type	Mat. no.			p [bar]							
		30			0.3	0.5	1.0	2.0	5.0	10.0		
90°	308.466	●	2.00	2.00	0.54	0.70	1.00	1.40	2.21	3.13	440	830
	308.606	●	4.00	4.00	1.22	1.58	2.23	3.15	4.98	7.04	460	850

Conversion formula for this series: $\dot{V}_2 = \dot{V}_1 \cdot \sqrt{\frac{p_2}{p_1}}$

Ordering Type + Material no. = Ordering no.
example: 308.466 + 30 = 308.466.30

Assembly accessories can be found in Chapter 9 "Accessories".

➤ Tangential-flow hollow cone nozzles

Series 304/306/307

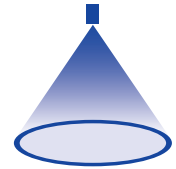

Features:

- Uniform atomization
- Non-clogging nozzle without swirl insert

Applications:

- Storage tank cooling
- Foam control
- Dust control
- Surface spraying
- Absorption



Series 304/306/307

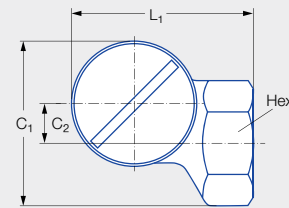
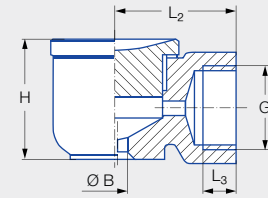

Series	G	Dimensions [mm]							Weight [g] (Brass)
		C ₁	C ₂	H	L ₁	L ₂	L ₃	Hex	
304	1/2 BSPP	43.0	11.0	33.0	46.0	30.0	11.0	27	205.0
306/307	3/4 BSPP	54.0	13.0	43.0	60.0	40.0	13.0	36	410.0

Spray angle	Ordering no.		Bore diameter B [mm]	Narrowest free cross section Ø [mm]	G ISO 228	V̇ water [l/min]							Spray diameter D [mm] (at p = 2 bar)		
	Type	Mat. no.				p [bar]							H = 250 [mm]	H = 500 [mm]	
		1Y				30	0.5	1.0	2.0	3.0	5.0	7.0			10.0
90°	304.706	●	●	5.10	5.10	1/2	2.80	3.96	5.60	6.86	8.85	10.48	12.52	500	1,000
	304.796	●	●	8.90	6.00	1/2	4.75	6.72	9.50	11.64	15.02	17.77	21.24	500	1,000
	306.906	●	●	9.00	9.00	3/4	9.00	12.73	18.00	22.05	28.46	33.67	40.25	550	1,050
	306.976	●	●	13.50	10.00	3/4	13.25	18.74	26.50	32.46	41.90	49.58	59.26	550	1,050
130°	304.818		●	12.00	5.00	1/2	5.30	7.50	10.60	12.98	16.76	19.83	23.70	1,200	2,100
	304.898	●	●	12.00	7.00	1/2	8.50	12.02	17.00	20.82	26.88	31.80	38.01	1,250	2,200
	306.978		●	19.00	7.30	3/4	13.25	18.74	26.50	32.46	41.90	49.58	59.26	1,300	2,350
	307.018	●	●	19.00	8.60	3/4	16.75	23.69	33.50	41.03	52.97	62.67	74.91	1,300	2,350

Conversion formula for this series: $\dot{V}_2 = \dot{V}_1 \cdot \sqrt{\frac{P_2}{P_1}}$

Ordering Type + Material no. = Ordering no.
example: 304.706 + 1Y = 307.706.1Y

Assembly accessories can be found in Chapter 9 "Accessories".

➤ Tangential-flow hollow cone nozzles Series 350

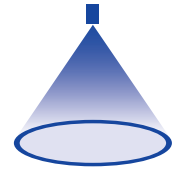

Features:

- High performance nozzle for humidification of air
- Very narrow droplet spectrum
- Extremely uniform liquid distribution over the entire spray pattern
- Quick-release clamp unit available for pipe mounting

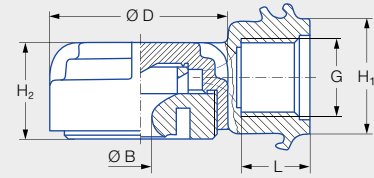

Applications:

- Foam control
- Dust control
- Surface spraying
- Absorption

Series 350

G	Dimensions [mm]				Weight [g]	P _{max} [bar]
	H ₁	H ₂	L	Ø D		
3/8 BSPP	24.0	20.0	14.0	37.0	37.0	20.0

Spray angle	Ordering no.		Bore diameter B [mm]	Narrowest free cross section Ø [mm]	V̇ water [l/min]							Spray diameter D [mm] (at p = 2 bar)	
	Type	Mat. no.			p [bar]							 H = 250 [mm] H = 500 [mm]	
		56			0.5	1.0	2.0	3.0	5.0	7.0	10.0		
130°	350.368	●	1.55	0.70	0.32	0.45	0.63	0.77	1.00	1.18	1.41	950	1,250
	350.608	●	5.00	1.40	1.58	2.23	3.15	3.86	4.98	5.89	7.04	990	1,950

Accessories:

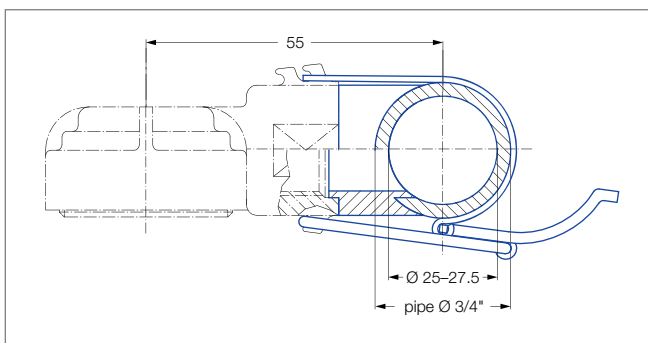

Recommended bore diameter 18 mm.
Quick-release clamp unit: Ordering no. 035.030.15.05.00.0.
Consisting of: Stainless steel clamp, polyurethane gasket.

Conversion formula for this series: $\dot{V}_2 = \dot{V}_1 \cdot \sqrt{\frac{p_2}{p_1}}$

Ordering Type + Material no. = Ordering no.
example: 350.368 + 56 = 350.368.56

 Assembly accessories can be found in Chapter 9 "Accessories".

➤ Eccentric hollow cone nozzles Series 373 Ramp Bottom

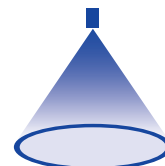

Features:

- Fine, uniform atomization even at low pressure
- Patented swirl chamber with built-in ramp extends service life

Applications:

- Gas cooling
- Water recooling
- Dust control

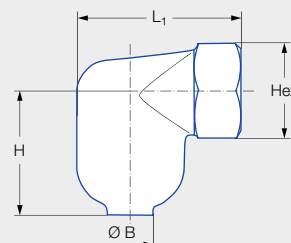

Series 373

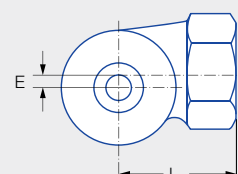

Code	G	Dimensions [mm]					Weight [g]
		H	L ₁	L ₂	E	Hex	
AN	1 BSPP	52.0	67.0	45.0	6.3	41	285.0
AQ	1 1/4 BSPP	65.0	77.0	51.0	7.9	48	570.0
AS	1 1/2 BSPP	81.0	97.0	65.0	7.9	58	900.0

Spray angle	Ordering no.				Bore diameter B [mm]	V̇ water [l/min]						Spray diameter D [mm] (at p = 2 bar)		
	Type	Mat. no.	Code			p [bar]						H = 500 [mm]	H = 1,000 [mm]	
		17					0.3	0.5	1.0	2.0	5.0			10.0
80°	373.115	●	AN			11.40	24.40	31.50	44.55	63.00	99.61	140.87	670	1,200
	373.175	●	AN			12.90	30.98	40.00	56.57	80.00	126.49	178.89	800	1,450
	373.235	●		AQ		16.20	45.70	59.00	83.44	118.00	186.57	263.86	750	1,300
	373.285	●		AQ		20.50	61.97	80.00	113.14	160.00	252.98	357.77	800	1,350
	373.325	●			AS	22.20	77.46	100.00	141.42	200.00	316.23	447.21	900	1,500
	373.365	●			AS	23.60	87.92	113.50	160.51	227.00	358.92	507.59	830	1,400

Conversion formula for this series: $\dot{V}_2 = \dot{V}_1 \cdot \sqrt{\frac{P_2}{P_1}}$

Ordering Type + Material no. + Code = Ordering no.
example: 373.115 + 17 + AN = 373.115.17.AN

Assembly accessories can be found in Chapter 9 "Accessories".



➤➤ FULL CONE NOZZLES



➤ FULL CONE NOZZLES OVERVIEW OF TYPES

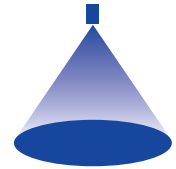

Lechler full cone nozzles are characterised by uniform liquid distribution over the entire circular impact area and are used, among other things, for surface spraying, in cleaning and washing processes and also in chemical process engineering. Full cone nozzles come in a variety of sizes and are made available as an axial full cone or a tangential full cone design. For special applications, unique types are made available, e.g. cluster head nozzles and deflector-plate nozzles.

Axial-flow full cone nozzles



- Axial flow
- Uniform liquid distribution
- Full surface impact
- Extensive flow rate range
- Extensive range of spray angles
- Standard materials:
Stainless steel 316Ti/316L, Brass, PVDF (special material available on request)

Tangential-flow full cone nozzles



- Tangential flow
- Uniform liquid distribution
- Full surface impact
- Maximum free passage making less susceptible to clogging
- Stable spray angle
- Standard materials:
Stainless steel 316L, Brass, PVDF (special material available on request)

Cluster head nozzles

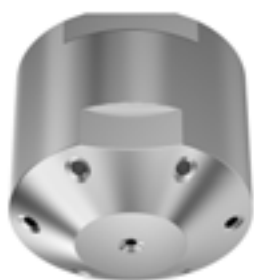

- Axial flow
- Multi-nozzle spray head
- Full surface impact
- Atomized spray – very fine droplets
- Small droplet sizes
- Enlarged droplet surface area
- Standard materials:
Stainless steel 316Ti/316L, Brass
(special material available on request)







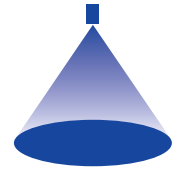

Deflector-plate nozzles









- Axial flow
- Large impact area
- Large free cross sections
- Standard materials:
Stainless steel 316Ti/316L, Brass
(special material available on request)

FULL CONE NOZZLES OVERVIEW OF SERIES



		Axial-flow full cone nozzles			
					
Series		490/491	460/461	405	403
Information on page		84	87	89	90
 Flow rate at p = 2 bar	Very low < 5 l/min	•	•		
	Low 5 l/min–25 l/min	•	•		
	Medium 25 l/min–80 l/min	•	•		
	High 80 l/min–400 l/min			•	
	Very high > 400 l/min				•
 Spray angle	Small 45°	•			
	Medium 60°–90°	•	•	•	•
	Large ≥ 120°	•	•	•	•
 Nozzle material	Stainless steel	•		•	•
	Brass	•		•	
	Plastic		•		
 Nozzle connection		1/8 BSPT 1/4 BSPT 3/8 BSPT 1/2 BSPT 3/4 BSPP 1 BSPP	1/8 BSPT 1/4 BSPT 3/8 BSPT 1/2 BSPT 3/4 BSPT 3/4 BSPP 1 BSPP	1 1/4 BSPP 1 1/2 BSPP 2 BSPP	2 1/2 BSPP 3 BSPP 3 1/2 BSPP 4 BSPP

		Tangential-flow full cone nozzles		Cluster head nozzles	Deflector-plate nozzles
					
419	468	422/423	422 with bayonet quick-release system	502/503	524/525
91	92	93/95	97	98	99
	•	•	•	•	
	•	•		•	•
		•		•	•
• (at p = 1 bar)		•			•
• (at p = 1 bar)					
•	•	•	•	•	
•	•	•	•	•	•
•	•	•		•	•
	•	•		•	•
	•	•	•		
2 BSPP 2 1/2 BSPP 3 BSPP	Assembly with retaining nut 3/8 BSPP	1/4 BSPT 3/8 BSPT 1/2 BSPT 3/4 BSPT 1 BSPT	Assembly with bayonet quick-release system	1/2 BSPP 3/4 BSPP	1/2 BSPP

➤ Axial-flow full cone nozzles Series 490/491

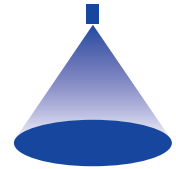

Features:

- Extremely uniform liquid distribution
- Very stable spray angle
- Non clogging due to large free cross sections

Applications:

- Cleaning and washing processes
- Surface spraying
- Chemical process engineering
- Foam control



Series 490/491

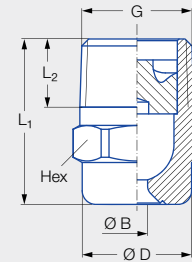

Figure 1

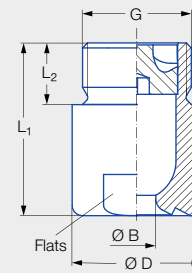

Figure 2

Code	Figure	G	Dimensions [mm]				Weight [g] (brass)
			L ₁	L ₂	Ø D	Hex/Flats	
CA	1	1/8 BSPT	18.0	6.5	10.0	11	13.0
CC	1	1/4 BSPT	22.0	10.0	13.0	14	16.0
CE	1	3/8 BSPT	24.5	10.0	16.0	17	30.0
CE	1	3/8 BSPT	30.0	10.0	16.0	17	50.0
CG	1	1/2 BSPT	32.5	13.0	21.0	22	60.0
CG	1	1/2 BSPT	43.5	13.0	21.0	22	85.0
AK	2	3/4 BSPP	42.0	15.0	32.0	27	190.0
AM	2	1 BSPP	56.0	17.0	40.0	36	350.0

Spray angle	Ordering no.								Bore diameter B [mm]	Narrowest free cross sections Ø [mm]	V̇ water [l/min]							Spray diameter D [mm] (at p = 2 bar)		
	Type	Mat. no.		Code							p [bar]							H = 250 [mm]	H = 500 [mm]	
		1Y	30	1/8 BSPT	1/4 BSPT	3/8 BSPT	1/2 BSPT	3/4 BSPP			1 BSPP	0.5	1.0	2.0	3.0	5.0	7.0			10.0
45°	490.403	●	●	CA						1.25	1.25	0.57	0.76	1.00	1.18	1.44	1.65	1.90	200	400
	490.523	●	●	CA						1.70	1.70	1.15	1.52	2.00	2.35	2.89	3.30	3.81	200	410
	490.603	●	●		CC	CE¹				2.00	2.00	1.81	2.39	3.15	3.70	4.54	5.20	6.00	200	410
	490.643	●	●		CC	CE¹				2.45	2.45	2.30	3.03	4.00	4.70	5.77	6.60	7.61	200	410
	490.683		●			CE				2.55	2.55	2.87	3.79	5.00	5.88	7.21	8.25	9.52	210	410
	490.703		●			CE				2.65	2.65	3.22	4.24	5.60	6.59	8.08	9.24	10.66	210	420
	490.723	●	●			CE				2.85	2.85	3.62	4.77	6.30	7.41	9.09	10.40	11.99	210	420
	490.783		●				CG			3.45	3.45	5.17	6.82	9.00	10.58	12.98	14.85	17.13	210	430
	490.843		●				CG			3.80	3.80	7.18	9.47	12.50	14.70	18.03	20.63	23.80	220	430

¹ Only available in material 30.

Spray angle	Ordering no.								Bore diameter B [mm]	Narrowest free cross sections Ø [mm]	V̇ water [l/min]						Spray diameter D [mm] (at p = 2 bar)			
	Type	Mat. no.		Code							p [bar]						H = 250 [mm]	H = 500 [mm]		
		1Y	30	1/8 BSPT	1/4 BSPT	3/8 BSPT	1/2 BSPT	3/4 BSPT			1 BSPT	0.5	1.0	2.0	3.0	5.0			7.0	10.0
		Stainless steel 316L	Brass																	
60°	490.404	●	●	CA						1.15	1.15	0.57	0.76	1.00	1.18	1.44	1.65	1.90	260	520
	490.444	●		CA						1.25	1.25	0.72	0.95	1.25	1.47	1.80	2.06	2.38	260	520
	490.484	●	●	CA						1.45	1.45	0.92	1.21	1.60	1.88	2.31	2.64	3.05	260	520
	490.524	●	●	CA						1.60	1.60	1.15	1.52	2.00	2.35	2.89	3.30	3.81	270	530
	490.564	●	●	CA						1.80	1.80	1.44	1.89	2.50	2.94	3.61	4.13	4.76	270	530
	490.604	●	●	CA	CC	CE				2.05	2.05	1.81	2.39	3.15	3.70	4.54	5.20	6.00	270	540
	490.644	●	●		CC	CE				2.30	2.30	2.30	3.03	4.00	4.70	5.77	6.60	7.61	270	540
	490.684	●	●		CC	CE				2.60	2.60	2.87	3.79	5.00	5.88	7.21	8.25	9.52	280	550
	490.724	●	●		CC	CE				2.95	2.80	3.62	4.77	6.30	7.41	9.09	10.40	11.99	280	560
	490.764	●	●			CE				3.25	3.25	4.59	6.06	8.00	9.41	11.54	13.20	15.23	290	560
	490.804	●	●			CE				3.70	3.70	5.74	7.58	10.00	11.76	14.43	16.51	19.04	290	570
	490.844	●	●				CG			4.05	4.05	7.18	9.47	12.50	14.70	18.03	20.63	23.80	290	570
	490.884	●	●				CG			4.65	4.65	9.19	12.13	16.00	18.82	23.08	26.41	30.46	300	580
	490.924	●	●					AK		5.20	5.20	11.49	15.16	20.00	23.52	28.85	33.01	38.07	300	590
	490.964	●	●					AK		5.80	5.80	14.36	18.95	25.00	29.40	36.07	41.26	47.59	300	590
	491.044	●	●						AM	7.25	7.25	22.97	30.31	40.00	47.04	57.71	66.02	76.15	300	600
491.084	●	●						AM	8.15	8.15	28.72	37.89	50.00	58.80	72.13	82.53	95.18	300	600	
90°	490.406	●	●	CA						1.20	1.20	0.57	0.76	1.00	1.18	1.44	1.65	1.90	490	880
	490.446		●	CA						1.30	1.30	0.72	0.95	1.25	1.47	1.80	2.06	2.38	490	900
	490.486	●	●	CA						1.45	1.45	0.92	1.21	1.60	1.88	2.31	2.64	3.05	500	900
	490.526	●	●	CA						1.70	1.55	1.15	1.52	2.00	2.35	2.89	3.30	3.81	500	910
	490.566	●	●	CA						1.90	1.90	1.44	1.89	2.50	2.94	3.61	4.13	4.76	510	920
	490.606	●	●	CA		CE				2.10	2.05	1.81	2.39	3.15	3.70	4.54	5.20	6.00	510	930
	490.646	●	●		CC	CE				2.40	2.40	2.30	3.03	4.00	4.70	5.77	6.60	7.61	520	950
	490.686	●	●		CC	CE				2.70	2.70	2.87	3.79	5.00	5.88	7.21	8.25	9.52	520	960
	490.726	●	●		CC	CE				3.20	2.80	3.62	4.77	6.30	7.41	9.09	10.40	11.99	530	970
	490.746	●	●			CE				3.15	3.15	4.08	5.38	7.10	8.35	10.24	11.72	13.52	530	980
	490.766	●	●			CE				3.40	3.40	4.59	6.06	8.00	9.41	11.54	13.20	15.23	540	980
	490.806	●	●			CE				3.90	3.90	5.74	7.58	10.00	11.76	14.43	16.51	19.04	550	990
	490.846	●	●			CE				4.65	4.00	7.18	9.47	12.50	14.70	18.03	20.63	23.80	550	1,000
	490.886	●	●				CG			5.45	4.50	9.19	12.13	16.00	18.82	23.08	26.41	30.46	550	1,010
	490.926	●	●				CG			5.90	4.50	11.49	15.16	20.00	23.52	28.85	33.01	38.07	560	1,010
	490.966	●	●				CG	AK		6.55	4.85	14.36	18.95	25.00	29.40	36.07	41.26	47.59	560	1,020
	491.006	●	●					AK		7.55	5.50	18.09	23.87	31.50	37.05	45.45	51.99	59.97	560	1,030
	491.046	●	●					AK		8.60	6.60	22.97	30.31	40.00	47.04	57.71	66.02	76.15	560	1,040
	491.086	●	●						AM	9.45	7.25	28.72	37.89	50.00	58.80	72.13	82.53	95.18	560	1,040
491.126	●	●						AM	10.40	8.00	36.18	47.75	63.00	74.09	90.89	103.98	119.93	560	1,040	
491.146	●							AM	11.00	7.50	40.78	53.81	71.00	83.50	102.43	117.19	135.16	560	1,040	
120°	490.368	●	●	CA						0.85	0.65	0.36	0.48	0.63	0.74	0.91	1.04	1.20	700	1,240
	490.408	●	●	CA						1.20	1.20	0.57	0.76	1.00	1.18	1.44	1.65	1.90	720	1,260
	490.448	●	●	CA						1.30	1.30	0.72	0.95	1.25	1.47	1.80	2.06	2.38	740	1,280
	490.488	●	●	CA						1.45	1.45	0.92	1.21	1.60	1.88	2.31	2.64	3.05	760	1,300
	490.528	●	●	CA						1.70	1.70	1.15	1.52	2.00	2.35	2.89	3.30	3.81	780	1,320
	490.568	●	●	CA						1.90	1.90	1.44	1.89	2.50	2.94	3.61	4.13	4.76	800	1,340





Spray angle	Ordering no.									Bore diameter B [mm]	Narrowest free cross sections Ø [mm]	V̇ water [l/min]							Spray diameter D [mm] (at p = 2 bar)	
	Type	Mat. no.		Code								p [bar]							H = 250 [mm]	H = 500 [mm]
		1Y	30	1/8 BSPT	1/4 BSPT	3/8 BSPT	1/2 BSPT	3/4 BSPP	1 BSPP			0.5	1.0	2.0	3.0	5.0	7.0	10.0		
		Stainless steel 316L	Brass																	
120°	490.608	●	●	CA						2.10	2.05	1.81	2.39	3.15	3.70	4.54	5.20	6.00	820	1,370
	490.648	●	●		CC	CE				2.40	2.40	2.30	3.03	4.00	4.70	5.77	6.60	7.61	840	1,400
	490.688	●	●		CC	CE				2.75	2.75	2.87	3.79	5.00	5.88	7.21	8.25	9.52	850	1,430
	490.728	●	●		CC	CE				3.20	2.80	3.62	4.77	6.30	7.41	9.09	10.40	11.99	860	1,470
	490.748	●	●			CE				3.20	3.20	4.08	5.38	7.10	8.35	10.24	11.72	13.52	870	1,500
	490.768	●	●			CE				3.45	3.45	4.59	6.06	8.00	9.41	11.54	13.20	15.23	880	1,530
	490.808	●	●			CE				3.90	3.90	5.74	7.58	10.00	11.76	14.43	16.51	19.04	900	1,580
	490.848	●	●			CE				4.70	4.00	7.18	9.47	12.50	14.70	18.03	20.63	23.80	910	1,630
	490.888	●	●					CG		5.10	4.50	9.19	12.13	16.00	18.82	23.08	26.41	30.46	920	1,680
	490.928	●	●					CG		5.80	4.75	11.49	15.16	20.00	23.52	28.85	33.01	38.07	930	1,700
	490.968	●	●					CG	AK	6.65	4.85	14.36	18.95	25.00	29.40	36.07	41.26	47.59	930	1,710
	491.048	●	●						AK	9.10	5.85	22.97	30.31	40.00	47.04	57.71	66.02	76.15	930	1,730
	491.128	●	●						AM	10.80	7.75	36.18	47.75	63.00	74.09	90.89	103.98	119.93	930	1,740
	491.148	●							AM	11.40	7.65	40.78	53.81	71.00	83.50	102.43	117.19	135.16	930	1,750

Conversion formula for this series: $\dot{V}_2 = \dot{V}_1 \cdot \left(\frac{p_2}{p_1}\right)^{0.4}$
 (≤ 10 bar)

Ordering Type + Material no. + Code = Ordering no.
 example: 490.608 + 1Y + CA = 490.608.1Y.CA



Assembly accessories can be found in Chapter 9 "Accessories".

➤ Axial-flow full cone nozzles Series 460/461

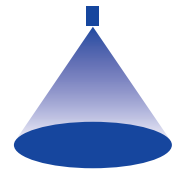

Features:

- Extremely uniform liquid distribution

Applications:

- Cleaning and washing processes
- Cooling
- Surface spraying
- Chemical process engineering



Series 460/461

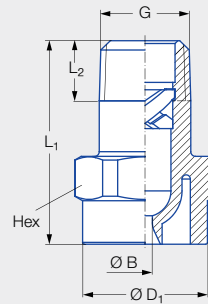

Figure 1

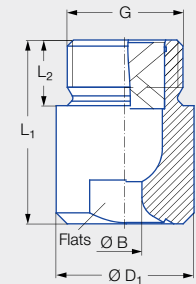

Figure 2

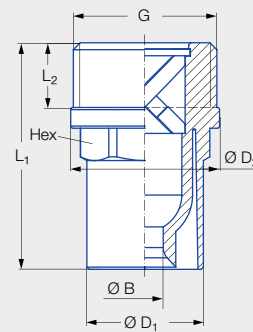



Figure 3

Code	Figure	G	Dimensions [mm]					Weight [g]
			L ₁	L ₂	Ø D ₁	Ø D ₂	Hex/Flats	
CA	1	1/8 BSPT	22.0	6.5	13.0	–	14	2.7
CC	1	1/4 BSPT	22.0	9.7	13.0	–	14	3.3
CE	1	3/8 BSPT	30.0	10.0	17.0	–	17	6.4
CG	1	1/2 BSPT	43.5	13.2	22.0	–	22	14.5
CK	2	3/4 BSPT	42.0	15.0	31.5	–	27	19.9
AK	2	3/4 BSPP	42.0	15.0	31.5	–	27	24.3
AM	3	1 BSPP	52.5	15.0	27.0	34.5	27	34.4

Spray angle	Ordering no.								Bore diameter B [mm]	Narrowest free cross sections Ø [mm]	V̇ water [l/min]						Spray diameter D [mm] (at p = 2 bar)		
	Type	Mat. no.	Code								p [bar]						 H = 250 [mm] H = 500 [mm]		
			5E	1/8 BSPT	1/4 BSPT	3/8 BSPT	1/2 BSPT	3/4 BSPT			3/4 BSPP	1 BSPP	0.5	1.0	2.0	3.0			5.0
			PVDF																
60°	460.524	●	CA						1.60	1.60	1.15	1.52	2.00	2.35	2.89	3.30	3.81	210	380
	460.644	●	CC						2.40	1.90	2.30	3.03	4.00	4.70	5.77	6.60	7.61	240	420
	460.724	●	CC						2.80	2.10	3.15	4.45	6.30	7.72	8.91	9.96	14.09	260	450
	460.964	●						AK	5.80	4.90	14.36	18.95	25.00	29.40	36.07	41.26	47.59	310	560





Spray angle	Ordering no.								Bore diameter B [mm]	Narrowest free cross sections Ø [mm]	V̇ water [l/min]							Spray diameter D [mm] (at p = 2 bar)			
	Type	Mat. no.	Code								p [bar]										
		5E	1/8 BSPT	1/4 BSPT	3/8 BSPT	1/2 BSPT	3/4 BSPT	3/4 BSPP			1 BSPP	0.5	1.0	2.0	3.0	5.0	7.0		10.0	H = 250 [mm]	H = 500 [mm]
		PVDF																			
90°	460.326	●	CA							0.80	0.55	0.23	0.30	0.40	0.47	0.58	0.66	0.76	430	750	
	460.406	●	CA							1.20	0.85	0.57	0.76	1.00	1.18	1.44	1.65	1.90	440	780	
	460.486	●	CA							1.45	1.20	0.92	1.21	1.60	1.88	2.31	2.64	3.05	450	800	
	460.526	●	CA							1.65	1.30	1.15	1.52	2.00	2.35	2.89	3.30	3.81	450	820	
	460.606	●	CA		CE					2.05	1.45	1.81	2.39	3.15	3.70	4.54	5.20	6.00	470	850	
	460.646	●		CC						2.30	1.80	2.30	3.03	4.00	4.70	5.77	6.60	7.61	480	870	
	460.726	●			CE					2.95	2.00	3.62	4.77	6.30	7.41	9.09	10.40	11.99	500	900	
	460.746	●			CE					3.30	1.90	4.08	5.38	7.10	8.35	10.24	11.72	13.52	510	910	
	460.766	●			CE					3.30	2.40	4.59	6.06	8.00	9.41	11.54	13.20	15.23	510	910	
	460.806	●			CE					3.70	2.70	5.74	7.58	10.00	11.76	14.43	16.51	19.04	520	920	
	460.846	●			CE					4.05	3.20	7.18	9.47	12.50	14.70	18.03	20.63	23.80	520	930	
	460.886	●			CE	CG				4.70	3.10	9.19	12.13	16.00	18.82	23.08	26.41	30.46	520	930	
	460.926	●				CG				5.10	2.80	11.49	15.16	20.00	23.52	28.85	33.01	38.07	520	940	
	460.966	●				CG				5.80	3.80	14.36	18.95	25.00	29.40	36.07	41.26	47.59	520	940	
	461.006	●				CG				6.40	3.80	18.09	23.87	31.50	37.05	45.45	51.99	59.97	520	940	
461.046	●					CK			7.20	5.30	22.97	30.31	40.00	47.04	57.71	66.02	76.15	520	950		
461.086	●						AM		8.40	5.00	25.00	35.36	50.00	61.24	70.71	79.06	111.80	530	950		
120°	460.368	●	CA							0.95	0.65	0.32	0.45	0.63	0.77	0.89	1.00	1.41	650	1,030	
	460.408	●	CA							1.20	0.85	0.57	0.76	1.00	1.18	1.44	1.65	1.90	680	1,100	
	460.488	●	CA							1.50	1.00	0.92	1.21	1.60	1.88	2.31	2.64	3.05	700	1,160	
	460.528	●	CA							1.65	1.20	1.15	1.52	2.00	2.35	2.89	3.30	3.81	710	1,200	
	460.608	●	CA							2.10	1.40	1.81	2.39	3.15	3.70	4.54	5.20	6.00	730	1,270	
	460.648	●		CC						2.45	1.60	2.30	3.03	4.00	4.70	5.77	6.60	7.61	750	1,310	
	460.728	●			CE					3.10	1.90	3.62	4.77	6.30	7.41	9.09	10.40	11.99	780	1,380	
	460.748	●			CE					3.30	1.90	4.08	5.38	7.10	8.35	10.24	11.72	13.52	790	1,400	
	460.768	●			CE					3.50	1.90	4.59	6.06	8.00	9.41	11.54	13.20	15.23	790	1,410	
	460.808	●			CE					3.80	2.40	5.74	7.58	10.00	11.76	14.43	16.51	19.04	810	1,430	
	460.848	●			CE					4.20	2.70	7.18	9.47	12.50	14.70	18.03	20.63	23.80	820	1,450	
	460.888	●				CG				4.60	3.10	9.19	12.13	16.00	18.82	23.08	26.41	30.46	830	1,470	
	460.968	●				CG				5.90	4.10	14.36	18.95	25.00	29.40	36.07	41.26	47.59	850	1,500	
	461.048	● ¹					CK			7.60	4.90	22.97	30.31	40.00	47.04	57.71	66.02	76.15	870	1,530	

¹ Material PP (mat. no. 53).

Conversion formula for this series: $\dot{V}_2 = \dot{V}_1 \cdot \left(\frac{p_2}{p_1}\right)^{0.4}$
 (≤ 10 bar)

Ordering Type + Material no. + Code = Ordering no.
 example: 460.326 + 5E + CA = 460.326.5E.CA



Assembly accessories can be found in Chapter 9 "Accessories".

➤ Axial-flow full cone nozzles Series 405

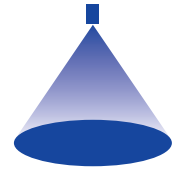

Features:

- Extremely uniform liquid distribution

Applications:

- Surface spraying
- Chemical process engineering
- Cleaning and washing processes
- Water treatment



Series 405

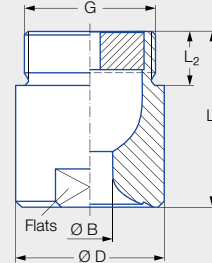

Code	G	Dimensions [mm]				Weight [kg] (brass)
		L ₁	L ₂	Ø D	Flats	
AP	1 1/4 BSPP	50.0	19.0	49.0	41	0.5
AR	1 1/2 BSPP	60.0	19.0	59.0	50	0.9
AV	2 BSPP	78.0	24.0	68.0	60	1.6

Spray angle	Ordering no.						Bore diameter B [mm]	Narrowest free cross sections Ø [mm]	V̇ water [l/min]						Spray diameter D [mm] (at p = 2 bar)	
	Type	Mat. no.		Code					p [bar]						H = 500 [mm]	H = 1,000 [mm]
		1Y	30	1 1/4 BSPP	1 1/2 BSPP	2 BSPP			0.3	0.5	1.0	2.0	3.0	5.0		
		Stainless steel 316L	Brass													
60°	405.204	●	●	AP			11.2	5.8	47	57	76	100	118	144	600	1,140
	405.284	●	●		AR		14.3	7.0	75	92	121	160	188	231	630	1,210
	405.324	●	●			AV	16.4	7.5	94	115	152	200	235	289	650	1,250
	405.364	●	●			AV	18.4	8.5	117	144	189	250	294	361	650	1,250
	405.404	●				AV	20.0	7.0	147	181	239	315	370	454	650	1,250
90°	405.206	●	●	AP			12.0	5.0	47	57	76	100	118	144	1,120	2,100
	405.286	●	●		AR		15.2	6.2	75	92	121	160	188	231	1,120	2,100
	405.326	●				AV	17.2	7.7	94	115	152	200	235	289	1,120	2,100
	405.366	●				AV	19.5	8.7	117	144	189	250	294	361	1,120	2,100
	405.406	●	●			AV	22.0	9.5	147	181	239	315	370	454	1,120	2,100
120°	405.208	●	●	AP			12.7	5.0	47	57	76	100	118	144	1,850	3,050
	405.288	●	●		AR		16.0	6.6	75	92	121	160	188	231	1,900	3,150
	405.328	●				AV	17.8	7.9	94	115	152	200	235	289	1,900	3,200
	405.368	●	●			AV	20.1	8.8	117	144	189	250	294	361	1,900	3,200
	405.408	●	●			AV	22.4	9.1	147	181	239	315	370	454	1,900	3,200

Conversion formula for this series: $\dot{V}_2 = \dot{V}_1 \cdot \left(\frac{p_2}{p_1}\right)^{0.4}$
(≤ 10 bar)

Ordering Type + Material no. + Code = Ordering no.
example: 405.204 + 1Y + AP = 405.204.1Y.AP

Assembly accessories can be found in Chapter 9 "Accessories".

➤ Axial-flow full cone nozzles Series 403

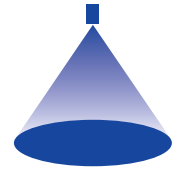

Features:

- Extremely uniform liquid distribution

Applications:

- Surface spraying
- Spraying over packings
- Chemical process engineering
- Cleaning and washing processes
- Cooling



Series 403

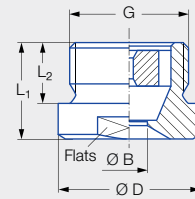

90° version

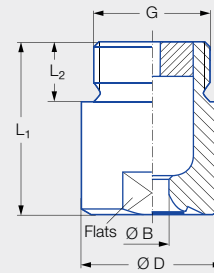

120° version

90° version

Type	G	Dimensions [mm]				Weight [kg]
		L ₁	L ₂	Ø D	Flats	
403.446/403.486	2 1/2 BSPP	52.0	27.0	83.0	75	1.3
403.526	3 BSPP	60.0	30.0	98.0	85	2.0
403.606	3 1/2 BSPP	70.0	32.0	118.0	105	3.6

120° version

Type	G	Dimensions [mm]				Weight [kg]
		L ₁	L ₂	Ø D	Flats	
403.448/403.488	2 1/2 BSPP	124.0	27.0	83.0	75	3.2
403.528	3 BSPP	153.0	30.0	98.0	85	5.4
403.608	3 1/2 BSPP	156.0	32.0	118.0	105	8.3
403.628	4 BSPP	165.0	36.0	128.0	110	9.6

Spray angle	Ordering no.		Bore diameter B [mm]	Narrowest free cross sections Ø [mm]	V̇ water [l/min]							Spray diameter D [mm] (at p = 2 bar)	
	Type	Mat. no.			p [bar]							 H = 500 [mm] H = 1,000 [mm]	
		1Y			0.3	0.5	1.0	2.0	3.0	5.0	7.0		
90°	403.446	●	25.0	12.0	187	230	303	400	470	577	660	1,000	1,780
	403.486	●	29.5	12.0	234	287	379	500	588	721	825	1,000	1,780
	403.526	●	32.0	13.8	295	362	477	630	741	909	1,040	1,000	1,780
	403.606	●	40.0	15.0	468	574	758	1,000	1,176	1,443	1,651	1,000	1,780
120°	403.448	●	25.5	10.0	187	230	303	400	470	577	660	1,700	2,930
	403.488	●	29.5	11.0	234	287	379	500	588	721	825	1,700	2,930
	403.528	●	32.0	15.0	295	362	477	630	741	909	1,040	1,700	2,930
	403.608	●	42.0	12.0	468	574	758	1,000	1,176	1,443	1,651	1,700	2,930
	403.628	●	45.0	15.0	585	718	947	1,250	1,470	1,803	2,063	1,700	2,930

Conversion formula for this series: $\dot{V}_2 = \dot{V}_1 \cdot \left(\frac{p_2}{p_1}\right)^{0.4}$
(≤ 10 bar)

Ordering Type + Material no. = Ordering no.
example: 403.446 + 1Y = 403.446.1Y

Assembly accessories can be found in Chapter 9 "Accessories".

➤ Axial-flow full cone nozzles

Series 419 FreeFlow

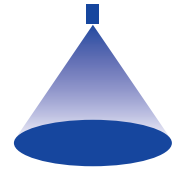

Features:

- Non clogging due to very large free cross sections
- Very stable spray angle
- Uniform liquid distribution

Applications:

- Cleaning and washing processes
- Dust control
- Absorption
- Distillation

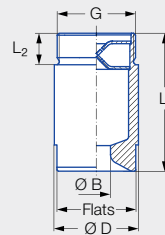

Figure 1

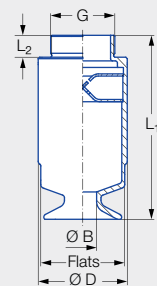



Figure 2

Series 419

Type	Code	Figure	G	Dimensions [mm]				Weight [kg]
				L ₁	L ₂	Ø D	Flats	
419.3xx	AV	1	2 BSPP	105.0	24.0	64.0	60	1.2
419.4xx	AV	2	2 BSPP	163.0	24.0	80.0	75	2.0
419.51x	AV	2	2 BSPP	199.0	24.0	102.0	95	3.7
419.51x	AY	2	2 1/2 BSPP	202.0	27.0	102.0	95	3.8
419.54x	AY	2	2 1/2 BSPP	202.0	27.0	102.0	95	3.8
419.57x	AY	2	2 1/2 BSPP	231.0	27.0	115.0	105	5.2
419.57x	LA	2	3 BSPP	233.0	30.0	115.0	105	5.2
419.6xx	LA	2	3 BSPP	252.0	30.0	122.0	115	5.4

Spray angle ¹	Ordering no.					Bore diameter B [mm]	Narrowest free cross sections Ø [mm]	V̇ water [l/min]					Spray diameter D [mm] (at p = 1 bar)	
	Type	Mat. no.	Code					p [bar]					 H = 500 [mm] H = 1,000 [mm]	
		1Y	Stainless steel 316L	2 BSPP	2 1/2 BSPP			3 BSPP	0.3	0.5	1.0	2.0		
90°	419.366	●	AV			19.0	17.5	117	143	189	249	360	1,200	2,200
	419.396	●	AV			21.2	17.5	140	172	227	300	432	1,200	2,200
	419.446	●	AV			24.0	20.5	187	230	303	400	577	1,200	2,200
	419.486	●	AV			29.0	20.5	234	287	379	500	721	1,200	2,200
	419.516	●	AV	AY		29.2	24.1	281	345	455	600	866	1,200	2,200
	419.546	●		AY		33.0	24.1	332	408	538	710	1,024	1,200	2,200
	419.576	●		AY	LA	35.0	27.2	398	488	644	850	1,226	1,200	2,200
	419.606	●			LA	37.5	30.1	468	574	758	1,000	1,443	1,200	2,200
	419.626	●			LA	43.0	30.1	585	718	947	1,250	1,803	1,200	2,200
120°	419.368	●	AV			21.0	17.4	117	143	189	249	360	1,660	2,900
	419.398	●	AV			24.2	17.4	140	172	227	300	432	1,660	2,900
	419.448	●	AV			24.5	20.5	187	230	303	400	577	1,660	2,900
	419.488	●	AV			29.5	20.5	234	287	379	500	721	1,660	2,900
	419.518	●	AV	AY		29.2	24.1	281	345	455	600	866	1,660	2,900
	419.548	●		AY		34.0	24.1	332	408	538	710	1,024	1,660	2,900
	419.578	●		AY	LA	35.0	28.6	398	488	644	850	1,226	1,660	2,900
	419.608	●			LA	38.0	32.2	468	574	758	1,000	1,443	1,660	2,900
	419.628	●			LA	43.5	32.2	585	718	947	1,250	1,803	1,660	2,900

¹ Spray angle at 1 bar.

Conversion formula for this series: $\dot{V}_2 = \dot{V}_1 \cdot \left(\frac{p_2}{p_1}\right)^{0.4}$
(≤ 10 bar)

Ordering Type + Material no. + Code = Ordering no.
example: 419.366 + 1Y + AV = 419.366.1Y.AV

 Assembly accessories can be found in Chapter 9 "Accessories".

➤ Axial-flow full cone nozzles Series 468

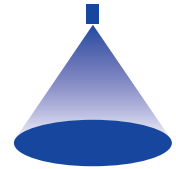

Features:

- Extremely uniform liquid distribution
- Assembly with retaining nut

Applications:

- Surface spraying
- Chemical process engineering
- Cleaning and washing processes
- Water treatment



Series 468

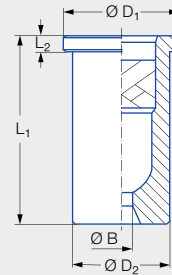

Code	Dimensions [mm]			Weight [g] (brass)
	L ₂	Ø D ₁	Ø D ₂	
Assembly with retaining nut 3/8 BSPP	2.00	14.80	12.65	18.00

Spray angle	Ordering no.				Bore diameter B [mm]	Narrowest free cross sections Ø [mm]	L ₁ [mm]	V̇ water [l/min]						Spray diameter D [mm] (at p = 2 bar)	
	Type	Mat. no.						p [bar]						H = 250 [mm]	H = 500 [mm]
		17 ¹	30	5E				0.5	1.0	2.0	3.0	5.0	10.0		
60°	468.604	●	●		2.05	1.40	18.00	1.81	2.39	3.15	3.70	4.54	6.00	280	560
	468.644		●	●	2.40	1.90	24.50	2.30	3.03	4.00	4.70	5.77	7.61	290	570
	468.684		●		2.60	2.00	24.50	2.87	3.79	5.00	5.88	7.21	9.52	300	580
	468.724	●	●		2.90	2.00	24.50	3.62	4.77	6.30	7.41	9.09	11.99	310	590
90°	468.526	●	●	●	1.65	1.30	18.00	1.15	1.52	2.00	2.35	2.89	3.81	460	780
	468.846	●	●		4.05	3.20	24.50	7.18	9.47	12.50	14.70	18.03	23.80	500	920
120°	468.368		●		0.95	0.70	18.00	0.36	0.48	0.63	0.74	0.91	1.20	740	1,750
	468.408	●	●		1.20	0.85	18.00	0.57	0.76	1.00	1.18	1.44	1.90	740	1,750
	468.488	●	●		1.50	1.00	18.00	0.92	1.21	1.60	1.88	2.31	3.05	740	1,750
	468.528	●	●		1.65	1.20	18.00	1.15	1.52	2.00	2.35	2.89	3.81	740	1,750

¹ We reserve the right to supply material 316Ti or 316L under material no. 17.

Conversion formula for this series: $\dot{V}_2 = \dot{V}_1 \cdot \left(\frac{p_2}{p_1}\right)^{0.4}$
(≤ 10 bar)

Ordering Type + Material no. = Ordering no.
example: 468.604 + 17 = 468.604.17



Assembly accessories can be found in Chapter 9 "Accessories".

➤ Tangential-flow full cone nozzles stainless steel/brass version Series 422/423

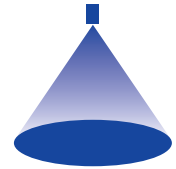

Features:

- Tangentially arranged supply of liquid
- Without swirl inserts
- Non-clogging
- Stable spray angle
- Uniform liquid distribution

Applications:

- Surface spraying
- Cooling
- Cleaning and washing processes
- Foam control

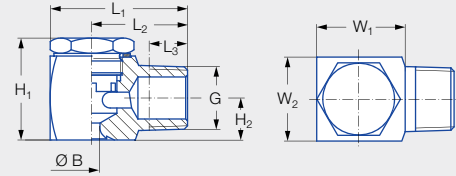
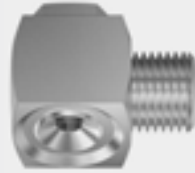

Figure 1

Series 422/423

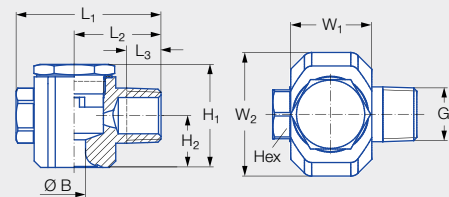
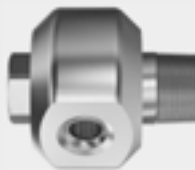



Figure 2

Code	Figure	G	Dimensions [mm]								Weight [g] (stainless steel 316L)
			H ₁	H ₂	L ₁	L ₂	L ₃	W ₁	W ₂	Hex	
CC	1	1/4 BSPT	21.0	8.0	28.0	20.0	9.7	15.6	16.0	–	44.0
CE	1	3/8 BSPT	26.7	11.0	36.0	25.0	10.1	23.2	22.0	–	101.0
CG	2	1/2 BSPT	40.0	20.0	56.0	33.5	13.2	32.0	48.0	19	370.0
CK	2	3/4 BSPT	57.0	23.5	65.5	38.5	14.5	40.0	63.0	27	830.0
CM	2	1 BSPT	66.0	27.3	85.0	48.5	16.8	55.0	78.0	36	1.581.0

Spray angle	Ordering no.							Bore diameter B [mm]	Narrowest free cross sections Ø [mm]	V̇ water [l/min]						Spray diameter D [mm] (at p = 2 bar)	
	Type	Mat. no.		Code						p [bar]							
		1Y	30	1/4 BSPT	3/8 BSPT	1/2 BSPT	3/4 BSPT			1 BSPT	0.5	1.0	2.0	3.0	5.0		
		Stainless steel 316L	Brass														
60°	422.644	●	●	CE				3.00	3.00	2.00	2.83	4.00	4.90	6.32	8.94	300	580
90°	422.406	●	●	CC				1.40	1.40	0.50	0.71	1.00	1.22	1.58	2.24	430	800
	422.486	●		CC				1.85	1.85	0.80	1.13	1.60	1.96	2.53	3.58	450	820
	422.566	●	●	CC				2.25	2.25	1.25	1.77	2.50	3.06	3.95	5.59	470	840
	422.606	●	●	CE				2.55	2.55	1.57	2.23	3.15	3.86	4.98	7.04	480	860
	422.646	●	●	CE				2.90	2.90	2.00	2.83	4.00	4.90	6.32	8.94	500	880
	422.726		●	CE				3.70	3.70	3.15	4.45	6.30	7.72	9.96	14.09	520	910
	422.766	●		CE				4.15	4.15	4.00	5.66	8.00	9.80	12.65	17.89	520	910
	422.806		●	CE				4.65	4.65	5.00	7.07	10.00	12.25	15.81	22.36	520	910
	422.846	●	●	CE				5.30	5.30	6.25	8.84	12.50	15.31	19.76	27.95	520	910
	422.886	●	●	CE				5.85	5.85	8.00	11.31	16.00	19.60	25.30	35.78	520	910
422.966	●			CG				8.00	8.00	12.50	17.68	25.00	30.62	39.53	55.90	520	910





Spray angle	Ordering no.								Bore diameter B [mm]	Narrowest free cross sections Ø [mm]	V̇ water [l/min]						Spray diameter D [mm] (at p = 2 bar)	
	Type	Mat. no.		Code							p [bar]						H = 250 [mm]	H = 500 [mm]
		1Y	30	1/4 BSPT	3/8 BSPT	1/2 BSPT	3/4 BSPT	1 BSPT			0.5	1.0	2.0	3.0	5.0	10.0		
		Stainless steel 316L	Brass															
120°	422.488		●	CC					1.90	1.90	0.80	1.13	1.60	1.96	2.53	3.58	670	1,200
	422.568	●	●	CC					2.45	2.40	1.25	1.77	2.50	3.06	3.95	5.59	700	1,230
	422.608		●		CE				2.70	2.70	1.57	2.23	3.15	3.86	4.98	7.04	710	1,250
	422.728	●	●		CE				4.00	3.90	3.15	4.45	6.30	7.72	9.96	14.09	770	1,360
	422.808	●			CE				4.90	4.90	5.00	7.07	10.00	12.25	15.81	22.36	830	1,490
	422.848	●	●		CE				5.30	5.30	6.25	8.84	12.50	15.31	19.76	27.95	860	1,550
	422.888	●	●		CE				6.60	6.00	8.00	11.31	16.00	19.60	25.30	35.78	880	1,570
	422.928	●				CG			7.30	7.30	10.00	14.14	20.00	24.49	31.62	44.72	890	1,580
	422.968	●	●			CG			8.00	8.00	12.50	17.68	25.00	30.62	39.53	55.90	890	1,590
	423.008	●				CG			8.70	8.70	15.75	22.27	31.50	38.58	49.81	70.44	890	1,590
	423.128	●					CK		12.70	12.30	31.50	44.55	63.00	77.16	99.61	140.87	890	1,590
423.208	●						CM	17.00	16.00	50.00	70.71	100.00	122.47	158.11	223.61	890	1,590	

Conversion formula for this series: $\dot{V}_2 = \dot{V}_1 \cdot \sqrt{\frac{p_2}{p_1}}$

Ordering Type + Material no. + Code = Ordering no.
 example: 422.488 + 30 + CC = 422.488.30.CC



Assembly accessories can be found in Chapter 9 "Accessories".

➤ Tangential-flow full cone nozzles, plastic version Series 422/423

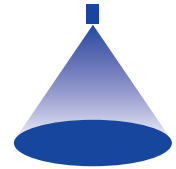

Features:

- Tangentially arranged supply of liquid
- Without swirl inserts
- Non-clogging
- Stable spray angle
- Uniform liquid distribution
- High chemical resistance

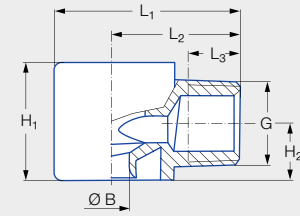

Applications:

- Surface spraying
- Cooling
- Cleaning and washing processes
- Foam control

Series 422/423

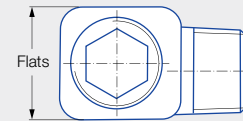

Code	G	Dimensions [mm]						Weight [g]
		H ₁	H ₂	L ₁	L ₂	L ₃	Flats	
CC	1/4 BSPT	16.0	8.0	28.0	20.0	9.8	16.0	7.0
CE	3/8 BSPT	23.0	11.2	36.0	25.0	10.1	22.0	16.0
CG	1/2 BSPT	38.0	19.2	49.5	33.5	13.2	32.0	40.0
CK	3/4 BSPT	50.0	24.5	58.5	38.5	18.5	41.0	50.0

Spray angle	Ordering no.						Bore diameter B [mm]	Narrowest free cross sections Ø [mm]	V̇ water [l/min]						Spray diameter D [mm] (at p = 2 bar)	
	Type	Mat. no.	Code						p [bar]						H = 250 [mm]	H = 500 [mm]
		5E	1/4 BSPT	3/8 BSPT	1/2 BSPT	3/4 BSPT			0.5	1.0	2.0	3.0	5.0	10.0		
60°	422.724	●		CE			3.60	3.60	3.15	4.45	6.30	7.72	9.96	14.09	320	560
90°	422.406	●	CC				1.50	1.45	0.50	0.71	1.00	1.22	1.58	2.24	530	900
	422.566	●	CC				2.30	2.20	1.25	1.77	2.50	3.06	3.95	5.59	530	920
	422.606	●		CE			2.60	2.50	1.58	2.23	3.15	3.86	4.98	7.04	540	920
	422.646	●		CE			3.00	2.90	2.00	2.83	4.00	4.90	6.32	8.94	540	930
	422.726	●		CE			3.70	3.60	3.15	4.45	6.30	7.72	9.96	14.09	550	950
	422.806	●		CE			4.65	4.60	5.00	7.07	10.00	12.25	15.81	22.36	560	980
	422.846	●		CE			5.30	5.30	6.25	8.84	12.50	15.31	19.76	27.95	560	990
	422.886	●		CE			5.80	5.80	8.00	11.31	16.00	19.60	25.30	35.78	570	1,010
	422.926	●			CG		7.30	7.30	10.00	14.14	20.00	24.49	31.62	44.72	570	1,030
	422.966	●			CG		8.00	8.00	12.50	17.68	25.00	30.62	39.53	55.90	580	1,040
	423.006	●			CG		8.70	8.70	15.75	22.27	31.50	38.58	49.81	70.44	580	1,040
423.126	●				CK	12.00	12.00	31.50	44.55	63.00	77.16	99.61	140.87	580	1,050	





Spray angle	Ordering no.						Bore diameter B [mm]	Narrowest free cross sections Ø [mm]	V̇ water [l/min]						Spray diameter D [mm] (at p = 2 bar)	
	Type	Mat. no.	Code						p [bar]						H = 250 [mm]	H = 500 [mm]
		5E	1/4 BSPT	3/8 BSPT	1/2 BSPT	3/4 BSPT			0.5	1.0	2.0	3.0	5.0	10.0		
		PVDF														
120°	422.408	●	CC				1.50	1.45	0.50	0.71	1.00	1.22	1.58	2.24	670	1,200
	422.448	●	CC				1.65	1.60	0.63	0.88	1.25	1.53	1.98	2.80	680	1,210
	422.488	●	CC				1.90	1.90	0.80	1.13	1.60	1.96	2.53	3.58	680	1,230
	422.568	●	CC				2.40	2.40	1.25	1.77	2.50	3.06	3.95	5.59	700	1,260
	422.728	●		CE			4.00	3.90	3.15	4.45	6.30	7.72	9.96	14.09	770	1,400
	422.888	●		CE			6.60	6.00	8.00	11.31	16.00	19.60	25.30	35.78	940	1,590
	422.968	●			CG		8.00	8.00	12.50	17.68	25.00	30.62	39.53	55.90	960	1,620
	423.008	●			CG		8.70	8.70	15.75	22.27	31.50	38.58	49.81	70.44	970	1,630
423.128	●				CK	12.70	12.30	31.50	44.55	63.00	77.16	99.61	140.87	990	1,660	

Conversion formula for this series: $\dot{V}_2 = \dot{V}_1 \cdot \sqrt{\frac{p_2}{p_1}}$

Ordering Type + Material no. + Code = Ordering no.
 example: 422.408 + 5E + CC = 422.408.5E.CC



Assembly accessories can be found in Chapter 9 "Accessories".

➤ Tangential-flow full cone nozzles, plastic version with bayonet quick-release system Series 422

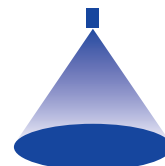

Features:

- Without swirl inserts
- Non-clogging
- Stable spray angle
- Simple and quick assembly
- Uniform liquid distribution
- High chemical resistance



Applications:

- Surface spraying
- Cooling
- Cleaning and washing processes
- Foam control

Series 422

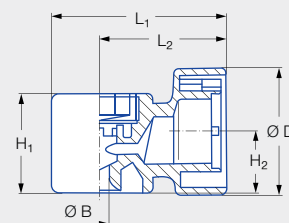

Figure 1

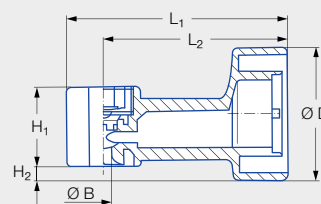



Figure 2

Type	Code	Figure	Dimensions [mm]					Weight [g] (PVDF)
			H ₁	H ₂	L ₁	L ₂	Ø D	
422,644/422,606/422,608	KB	1	23.0	14.0	40.0	29.0	29.5	20.0
422,406/422,408/422,528	KB	2	17.5	3.5	48.0	40.0	29.5	14.0

Spray angle	Ordering no.			Bore diameter B [mm]	Narrowest free cross sections Ø [mm]	V̇ water [l/min]						Spray diameter D [mm] (at p = 2 bar)		
	Type	Mat. no.				Code	p [bar]						 H = 250 [mm] H = 500 [mm]	
		5E	53											
		PVDF	PP				Bayonet quick-release system	0.5	1.0	2.0	3.0	5.0	10.0	
60°	422.644		●	KB	2.90	2.90	2.00	2.83	4.00	4.90	6.32	8.94	250	490
90°	422.406	●		KB	1.50	1.45	0.50	0.71	1.00	1.22	1.58	2.24	530	900
	422.606	●		KB	2.60	2.50	1.58	2.23	3.15	3.86	4.98	7.04	540	920
120°	422.408	●		KB	1.50	1.45	0.50	0.71	1.00	1.22	1.58	2.24	670	1,140
	422.528	●		KB	2.10	2.00	1.00	1.41	2.00	2.45	3.16	4.47	690	1,220
	422.608	●		KB	2.60	2.50	1.58	2.23	3.15	3.86	4.98	7.04	710	1,260

Conversion formula for this series: $\dot{V}_2 = \dot{V}_1 \cdot \sqrt{\frac{p_2}{p_1}}$

Ordering Type + Material no. + Code = Ordering no.
example: 422.644 + 53 + KB = 422.644.53.KB

 Assembly accessories can be found in Chapter 9 "Accessories".

Cluster head nozzles

Series 502/503

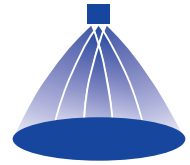

Features:

- Fine, uniform atomization
- Stable spray angle
- Space-saving installation
- Maintenance-friendly design
- High temperature and chemical resistance

Applications:

- Chlorine precipitation
- Absorption
- Dust suppression
- Degassing of liquids
- Desuperheating



Series 502/503

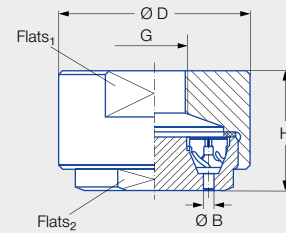

70° version

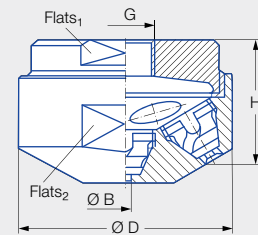

130° version

70° version

G	Dimensions [mm]				Weight [g] (brass)
	H	Ø D	Flats ₁	Flats ₂	
1/2 BSPP	25.0	50.0	46	38	250.0
3/4 BSPP	46.0	75.0	65	55	870.0

130° version

G	Dimensions [mm]				Weight [g] (brass)
	H	Ø D	Flats ₁	Flats ₂	
1/2 BSPP	28.0	40.0	27	36	150.0
3/4 BSPP	53.0	60.0	50	55	410.0

Spray angle	Ordering no.			BSPP	Bore diameter B [mm]	Narrowest free cross sections Ø [mm]	V̇ water [l/min]					Spray diameter D [mm] (at p = 2 bar)	
	Type	Mat. no.					p [bar]					H = 500 [mm]	H = 1,000 [mm]
		17 ¹	30				0.5	1.0	2.0	5.0	10.0		
70°	502.445		●	1/2	0.90	0.50	–	–	1.25	1.98	2.80	270	360
	502.985	●		3/4	3.30	2.00	14.00	19.80	28.00	44.27	62.61	610	1,000
	503.065	●		3/4	4.90	2.00	22.50	31.82	45.00	71.15	100.62	920	1,520
130°	502.448	●	●	1/2	0.90	0.50	–	–	1.25	1.98	2.80	310	370
	502.548	●	●	1/2	1.80	0.50	–	1.58	2.24	3.54	5.01	450	570
	502.748	●	●	3/4	1.90	1.90	3.55	5.02	7.10	11.23	15.88	1,110	1,400
	502.838	●	●	3/4	2.90	2.00	5.90	8.34	11.80	18.66	26.39	1,500	2,060
	502.908	●	●	3/4	4.00	2.00	9.00	12.73	18.00	28.46	40.25	1,770	2,650
	503.028	●	●	3/4	4.20	2.00	17.75	25.10	35.50	56.13	79.38	2,050	3,150
	503.118	●	●	3/4	6.50	2.00	30.00	42.43	60.00	94.87	134.16	2,300	3,550

¹ We reserve the right to supply material 316Ti or 316L under material no. 17.

Conversion formula for this series: $\dot{V}_2 = \dot{V}_1 \cdot \sqrt{\frac{p_2}{p_1}}$

Ordering Type + Material no. = Ordering no.
 example: 502.445 + 30 = 502.445.30

Assembly accessories can be found in Chapter 9 "Accessories".

Deflector-plate nozzles

Series 524/525

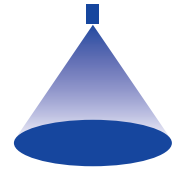

Features:

- Full cone atomization
- Large impact area
- Non-clogging

Applications:

- Fire fighting
- Sprinkling
- Dust suppression

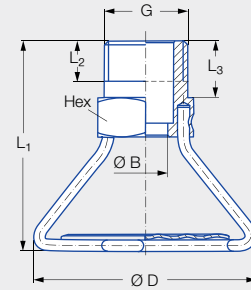

Series 524/525

G	Dimensions [mm]					Weight [g] (brass)
	L ₁	L ₂	L ₃	Ø D	Hex	
1/2 BSPP	53.5	11.0	14.5	56.0	24	68.0

Spray angle	Ordering no.			Bore diameter B [mm]	V̇ water [l/min]						Spray diameter D [mm] (at p = 2 bar)	
	Type	Mat. no.			p [bar]						H = 1,000 [mm]	H = 3,000 [mm]
		17 ¹	30		0.5	1.0	2.0	3.0	5.0	10.0		
180°	524.809	●	●	4.00	5.00	7.07	10.00	12.25	15.81	22.36	3,800	4,300
	525.049	●	●	8.00	20.00	28.28	40.00	48.99	63.25	89.44	10,000	11,500
	525.109		●	9.30	28.00	39.60	56.00	89.59	88.54	125.22	10,500	12,750
	525.169		●	10.90	40.00	56.57	80.00	97.98	126.49	178.89	10,500	14,500
	525.229		●	12.20	56.00	79.20	112.00	137.17	177.09	250.44	7,500	11,500
	525.269	●	●	12.30	70.00	98.99	140.00	171.46	221.36	313.05	7,000	12,000

¹ We reserve the right to supply material 316Ti or 316L under material no. 17.

Conversion formula for this series: $\dot{V}_2 = \dot{V}_1 \cdot \sqrt{\frac{p_2}{p_1}}$

Ordering Type + Material no. = Ordering no.
example: 524.809 + 17 = 524.809.17

Assembly accessories can be found in Chapter 9 "Accessories".



FLAT FAN NOZZLES

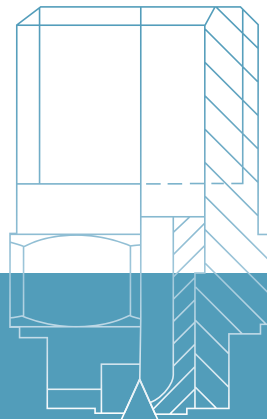

FLAT FAN NOZZLES OVERVIEW OF TYPES

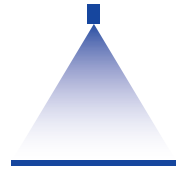

Lechler flat fan nozzles produce intensive, uniform water jet. Flat fan nozzles are generally used in cleaning processes and throughout many areas of surface treatment. Numerous designs – including tongue-type nozzles for special applications – and extensive assembly accessories enable easy installation as well as quick nozzle changeovers.

Standard flat fan nozzles



- Particularly high-energy spray with spray angles of up to 60°
- Parabolic liquid distribution
- Unaffected by transient pressures
- Simple and cost-saving assembling options

Tongue-type nozzles

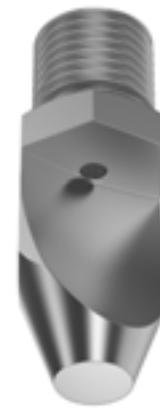

- Special design in which a solid stream is diverted by a deflector plate
- Powerful, sharply delimited spray
- Shape of the deflector plate determines the spray angle
- Clog resistant due to large free cross-sections

International nozzle code

Flat fan nozzles designations are governed by international standards. The first two digits specify the spray angle in degrees, the others the flow rate in US gallons per minute at 40 psi. Our high pressure flat fan nozzles (series 602/608/652/6FH) are specified with this international nozzle code.

Spray angle
in degrees



Flow rate in US gal/min at 40 psi





Conversion: $\text{Value} \cdot 3.22 = \text{flow rate in l/min at 2 bar}$
example: 0.2 gal/min at 40 psi = 0.644 l/min at 2 bar

Good to know

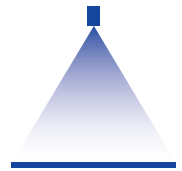
Information on the arrangement of several flat fan nozzles can be found in Chapter "Planning Aids" on Page 255.









FLAT FAN NOZZLES OVERVIEW OF SERIES







		Standard flat fan nozzles				
						
Series		632/633	610	612	616/617	652
Information on page		108	111	113	116	118
Pressure range	Low pressure	•	•	•	•	•
	High pressure					
Flow rate at p = 5 bar	Low < 4 l/min	•	•	•		•
	Medium 4 l/min–16 l/min	•	•	•	•	•
	High 16 l/min–50 l/min	•		•	•	•
	Very high > 50 l/min				•	
Spray angle	Small 20°–45°	•	•	•	•	•
	Medium 60°–90°	•	•	•	•	•
	Large 120°–140°	•	•	•	•	•
Nozzle material	Stainless steel	•	•	•	•	•
	Brass	•	•	•	•	•
	Plastic	•				•
Nozzle connection		1/8 BSPT 1/4 BSPT 3/8 BSPT 1/2 BSPT	1/8 BSPP	1/4 BSPP	3/4 BSPP	Assembly with retaining nut 3/8 BSPP













		Standard flat fan nozzles			
					
Series		652 Belt lubrication nozzle	612.xxx.5E.03 Press-in nozzle	656/657	660
Information on page		121	122	123	125
Pressure range	Low pressure	•	•	•	•
	High pressure				
 Flow rate at p = 5 bar	Low < 4 l/min	• (at p = 3 bar)	• (at p = 2 bar)		•
	Medium 4 l/min–16 l/min			•	•
	High 16 l/min–50 l/min			•	
	Very high > 50 l/min			•	
 Spray angle	Small 20°–45°			•	•
	Medium 60°–90°	•	•	•	•
	Large 120°–140°	•	•	•	•
 Nozzle material	Stainless steel	•		•	•
	Brass			•	•
	Plastic	•	•		
 Nozzle connection		Assembly with retaining nut 3/8 BSPP	For pressing into pipes	Assembly with retaining nut 3/4 BSPP	Assembly with retaining nut 3/8 BSPP and dovetail guide

		Tongue-type nozzles		
				
664/665	646	688/689	686	684
127	129	131	132	134
•	•	•	•	•
	•		• (at p = 2 bar)	• (at p = 2 bar)
•	•	• (at p = 2 bar)	• (at p = 2 bar)	• (at p = 2 bar)
•		• (at p = 2 bar)	• (at p = 2 bar)	
•				
•	•	•		
•	•		•	
•	•		•	•
•		•	•	
•			•	
	•	•	•	•
Assembly with retaining nut 3/4 BSPP and dovetail guide	Assembly with bayonet quick-release system	3/8 BSPT 3/4 BSPP	1/8 BSPT 1/4 BSPT 3/8 BSPT 1/2 BSPT	Assembly with retaining nut 3/8 BSPP





		Standard flat fan nozzles			
					
Series		602	608	652	6FH with spray stabiliser
Information on page		135	136	137	138
Pressure range	Low pressure				
	High pressure	•	•	•	•
Flow rate at p = 5 bar	Low < 4 l/min				
	Medium 4 l/min–16 l/min	• (at p = 80 bar)	• (at p = 80 bar)	• (at p = 80 bar)	• (at p = 80 bar)
	High 16 l/min–50 l/min	• (at p = 80 bar)	• (at p = 80 bar)	• (at p = 80 bar)	• (at p = 80 bar)
	Very high > 50 l/min	• (at p = 80 bar)		• (at p = 80 bar)	• (at p = 80 bar)
Spray angle	Small 20°–45°	•	•	•	•
	Medium 60°–90°	•	•	•	•
	Large 120°–140°				
Nozzle material	Stainless steel	•	•	•	•
	Brass				
	Plastic				
Nozzle connection		1/4 BSPT 1/4 NPT	1/8 BSPT 1/8 NPT	Assembly with retaining nut 3/8 BSPP	1/8 BSPT 1/8 NPT 1/4 BSPT 1/4 NPT Assembly with retaining nut 3/8 BSPP

Swivelling nozzles	Nozzle systems for surface treatment		Descaling nozzles
			
676	676/677 MEMOSPRAY	676 Easy-Clip	SCALEMASTER
140	142	146	Upon request
•	•	•	
•			
•	• (at p = 2 bar)	• (at p = 2 bar)	
	• (at p = 2 bar)	• (at p = 2 bar)	
•	•		
•	•	•	
•	•		
•	•		
•			
	•	•	
Assembly with retaining nut Welded nipple Threaded nipple Threaded socket	Eyelet clamps for following pipe sizes: 1" 1 1/4" 1 1/2" 2"	Eyelet clamps for following pipe sizes: 1" 1 1/4" 1 1/2" 2"	

Low pressure flat fan nozzles

Series 632/633

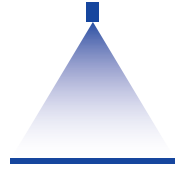

Features:

- Uniform, parabolic liquid distribution
- Stable spray angle
- Tapered, self-sealing thread

Applications:

- Spray cleaning
- Surface cleaning
- Strainer insert cleaning
- Coating processes
- Belt cleaning
- Lubrication processes



Series 632/633

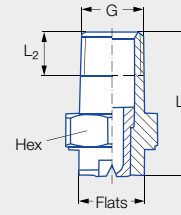

Figure 1

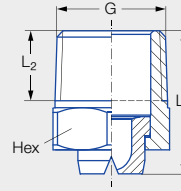

Figure 2

Code	Figure	G	Dimensions [mm]				Weight [g] (Brass)
			L ₁	L ₂	Hex	Flats	
CA	1	1/8 BSPT	22.0	6.5	14	10	17.0
CC	1	1/4 BSPT	22.0	9.7	14	10	20.0
CE	2	3/8 BSPT	22.0	10.1	17	-	30.0
CG	2	1/2 BSPT	27.0	13.2	22	-	40.0

Spray angle	Ordering no.								Equivalent bore diameter A [mm]	Narrowest free cross section Ø [mm]	V̇ water [l/min]							Spray width B [mm] (at p = 5 bar)		
	Type	Mat. no.				Code					p [bar]									
		16 ¹	17 ²	30	5E															
		Stainless steel 303/ Stainless steel 304	Stainless steel 316Ti/ Stainless steel 316L	Brass	PVDF	1/8 BSPT	1/4 BSPT	3/8 BSPT			1/2 BSPT	0.5	1.0	2.0	3.0	5.0	7.0	10.0	H = 250 [mm]	H = 500 [mm]
20°	632.301	●	●	●	●	CA	CC			0.70	0.60	0.16*	0.23*	0.32	0.39	0.51	0.60	0.72	85	160
	632.361	●	●	●	●	CA	CC			1.00	0.80	0.31*	0.44*	0.63	0.77	1.00	1.18	1.40	85	160
	632.441	●	●	●	●	CA	CC			1.35	1.10	0.62*	0.88	1.25	1.53	1.98	2.34	2.80	85	160
	632.481	●	●	●	●	CA	CC			1.50	1.20	0.80*	1.13	1.60	1.96	2.53	2.99	3.58	85	160
30°	632.302	●	●	●	●	CA	CC			0.60	0.50	0.16*	0.23*	0.32	0.39	0.51	0.60	0.72	120	220
	632.362	●	●	●	●	CA	CC			1.00	0.70	0.31*	0.44*	0.63	0.77	1.00	1.18	1.40	120	220
	632.402	●	●	●	●	CA	CC			1.20	0.90	0.50*	0.71	1.00	1.23	1.58	1.87	2.24	120	230
	632.482	●	●	●	●	CA	CC			1.50	1.10	0.80*	1.13	1.60	1.96	2.53	2.99	3.58	130	230
	632.562	●	●	●	●	CA	CC			2.00	1.50	1.25	1.77	2.50	3.06	3.95	4.68	5.59	130	240
	632.642	●	●	●			CC			2.50	1.80	2.00	2.83	4.00	4.90	6.33	7.48	8.94	140	250
	632.722	●	●	●			CC			3.00	2.40	3.15	4.46	6.30	7.72	9.96	11.79	14.09	140	260
	632.762	●	●	●			CC			3.50	2.70	4.00	5.66	8.00	9.80	12.65	14.97	17.89	140	260
632.802	●	●	●			CC			4.00	3.10	5.00	7.07	10.00	12.25	15.81	18.71	22.36	140	260	

Spray angle	Ordering no.										Equivalent bore diameter A [mm]	Narrowest free cross section Ø [mm]	V̇ water [l/min]						Spray width B [mm] (at p = 5 bar)	
	Type	Mat. no.				Code				p [bar]						H = 250 [mm]	H = 500 [mm]			
		16 ¹	17 ²	30	5E	1/8 BSPT	1/4 BSPT	3/8 BSPT	1/2 BSPT	0.5			1.0	2.0	3.0			5.0	7.0	10.0
		Stainless steel 303/ Stainless steel 304	Stainless steel 316Ti/ Stainless steel 316L	Brass	PVDF															
45°	632.303	●	●	●		CA	CC			0.70	0.50	0.16*	0.23*	0.32	0.39	0.51	0.60	0.72	170	330
	632.363	●	●	●	●	CA	CC			1.00	0.60	0.31*	0.44*	0.63	0.77	1.00	1.18	1.40	190	350
	632.403	●	●	●	●	CA	CC			1.20	0.90	0.50*	0.71	1.00	1.23	1.58	1.87	2.24	200	370
	632.483	●	●	●	●	CA	CC			1.50	1.10	0.80*	1.13	1.60	1.96	2.53	2.99	3.58	200	390
	632.563	●	●	●	●	CA	CC			2.00	1.40	1.25	1.77	2.50	3.06	3.95	4.68	5.59	210	410
	632.643	●	●	●	●	CA	CC			2.50	1.80	2.00	2.83	4.00	4.90	6.33	7.48	8.94	220	410
	632.673	●	●	●			CC	CE		2.70	2.00	2.37	3.36	4.75	5.82	7.51	8.89	10.62	220	420
	632.723	●	●	●			CC	CE		3.00	2.40	3.15	4.46	6.30	7.72	9.96	11.79	14.09	220	420
	632.763	●	●	●			CC	CE		3.50	2.60	4.00	5.66	8.00	9.80	12.65	14.97	17.89	220	420
	632.803	●	●	●			CC	CE	CG	4.00	3.00	5.00	7.07	10.00	12.25	15.81	18.71	22.36	220	420
	632.843	●	● ³	●			CC		CG	4.50	3.40	6.25	8.84	12.50	15.31	19.76	23.38	27.94	220	420
	632.883	●	●	●					CG	5.00	3.80	8.00	11.31	16.00	19.60	25.30	29.94	35.78	220	420
	632.923	●	●	●					CG	5.50	4.20	10.00	14.14	20.00	24.49	31.62	37.41	44.72	220	430
632.963	●	●	●					CG	6.00	4.40	12.50	17.68	25.00	30.62	39.53	46.77	55.90	220	430	
60°	632.304	●	●	●	●	CA	CC			0.70	0.40	0.16*	0.23*	0.32	0.39	0.51	0.60	0.72	260	480
	632.334	●	●	●	●	CA	CC			0.90	0.50	0.22*	0.32*	0.45	0.55	0.71	0.84	1.00	260	490
	632.364	●	●	●	●	CA	CC			1.00	0.60	0.31*	0.44*	0.63	0.77	1.00	1.18	1.40	260	500
	632.404	●	●	●	●	CA	CC			1.20	0.80	0.50*	0.71	1.00	1.23	1.58	1.87	2.24	260	510
	632.444	●	●	●	●	CA	CC			1.35	0.90	0.62*	0.88	1.25	1.53	1.98	2.34	2.80	260	510
	632.484	●	●	●	●	CA	CC			1.50	1.00	0.80*	1.13	1.60	1.96	2.53	2.99	3.58	260	520
	632.514	●	●	●	●	CA	CC			1.65	1.10	0.95*	1.34	1.90	2.32	3.00	3.55	4.24	270	520
	632.564	●	●	●	●	CA	CC			2.00	1.30	1.25	1.77	2.50	3.06	3.95	4.68	5.59	270	530
	632.604	●	●	●	●	CA	CC			2.20	1.50	1.57	2.23	3.15	3.86	4.98	5.89	7.04	270	540
	632.644	●	●	●	● ⁴		CC	CE		2.50	1.60	2.00	2.83	4.00	4.90	6.33	7.48	8.94	270	540
	632.674	●	●	●	● ⁴		CC	CE		2.70	1.80	2.37	3.36	4.75	5.82	7.51	8.89	10.62	270	550
	632.724	●	●	●	● ⁴		CC	CE		3.00	2.10	3.15	4.46	6.30	7.72	9.96	11.79	14.09	280	560
	632.764	●	●	●			CC	CE		3.50	2.30	4.00	5.66	8.00	9.80	12.65	14.97	17.89	280	570
	632.804	●	● ³	●	● ⁴		CC		CG	4.00	2.60	5.00	7.07	10.00	12.25	15.81	18.71	22.36	290	580
	632.844	●	● ³	●	● ⁴		CC		CG	4.50	3.00	6.25	8.84	12.50	15.31	19.76	23.38	27.94	290	580
	632.884	●	● ³	●	● ⁴		CC		CG	5.00	3.40	8.00	11.31	16.00	19.60	25.30	29.94	35.78	290	580
	632.924	●	●	●					CG	5.50	4.10	10.00	14.14	20.00	24.49	31.62	37.41	44.72	290	580
	632.964	●	●	●					CG	6.00	4.20	12.50	17.68	25.00	30.62	39.53	46.77	55.90	290	580
	633.004	●	●	●					CG	7.00	4.80	15.75	22.27	31.50	38.57	49.80	58.92	70.43	290	580
633.044	●	●	●					CG	8.00	5.50	20.00	28.29	40.00	48.99	63.25	74.84	89.45	290	580	
633.084	●	●	●					CG	9.00	6.80	25.00	35.36	50.00	61.24	79.06	93.55	111.81	290	580	
75°	632.145	●		●		CA	CC			0.20	0.12	-	0.04*	0.05	0.06	0.08	0.09	0.11	380	690
	632.165	●		●		CA	CC			0.20	0.14	-	0.04*	0.06	0.08	0.10	0.12	0.14	380	690
	632.185	●		●		CA	CC			0.20	0.16	-	0.06*	0.08	0.10	0.13	0.15	0.18	380	690
	632.215	●		●		CA	CC			0.40	0.20	-	0.08*	0.11	0.14	0.18	0.21	0.25	380	690
	632.245	●		●		CA	CC			0.50	0.30	-	0.12*	0.16	0.20	0.26	0.31	0.37	380	690
	632.275	●		●		CA	CC			0.60	0.30	0.11*	0.16*	0.22	0.27	0.35	0.41	0.49	380	690





Spray angle	Ordering no.								Equivalent bore diameter A [mm]	Narrowest free cross section Ø [mm]	V̇ water [l/min]						Spray width B [mm] (at p = 5 bar)			
	Type	Mat. no.				Code					p [bar]						H = 250 [mm]	H = 500 [mm]		
		16 ¹	17 ²	30	5E	1/8 BSPT	1/4 BSPT	3/8 BSPT			1/2 BSPT	0.5	1.0	2.0	3.0	5.0			7.0	10.0
		Stainless steel 303/ Stainless steel 304	Stainless steel 316Ti/ Stainless steel 316L	Brass	PVDF															
90°	632.216	●		●		CA	CC			0.40	0.20	–	0.08*	0.11	0.14	0.18	0.21	0.25	420	780
	632.276	●		●		CA	CC			0.60	0.30	0.11*	0.16*	0.22	0.27	0.35	0.41	0.49	430	790
	632.306	●	●	●	●	CA	CC			0.70	0.40	0.16*	0.23*	0.32	0.39	0.51	0.60	0.72	440	800
	632.336	●	●	●	●	CA	CC			0.90	0.50	0.22*	0.32*	0.45	0.55	0.71	0.84	1.00	440	820
	632.366	●	●	●	●	CA	CC			1.00	0.50	0.31*	0.44*	0.63	0.77	1.00	1.18	1.40	450	830
	632.406	●	●	●	●	CA	CC			1.20	0.70	0.50*	0.71	1.00	1.23	1.58	1.87	2.24	450	840
	632.446	●	●	●	●	CA	CC			1.35	0.80	0.62*	0.88	1.25	1.53	1.98	2.34	2.80	460	860
	632.486	●	●	●	●	CA	CC			1.50	0.80	0.80*	1.13	1.60	1.96	2.53	2.99	3.58	470	870
	632.516	●	●	●	●	CA	CC			1.65	0.90	0.95*	1.34	1.90	2.32	3.00	3.55	4.24	480	880
	632.566	●	●	●	●	CA	CC			2.00	1.10	1.25	1.77	2.50	3.06	3.95	4.68	5.59	490	900
	632.606	●	●	●	●	CA	CC			2.20	1.20	1.57	2.23	3.15	3.86	4.98	5.89	7.04	500	910
	632.646	●	●	●	● ⁴		CC	CE		2.50	1.30	2.00	2.83	4.00	4.90	6.33	7.48	8.94	510	930
	632.676	●	●	●	● ⁴		CC	CE		2.70	1.40	2.37	3.36	4.75	5.82	7.51	8.89	10.62	510	950
	632.726	●	●	●	● ⁴		CC	CE		3.00	1.70	3.15	4.46	6.30	7.72	9.96	11.79	14.09	520	980
	632.766	●	●	●	● ⁴		CC	CE		3.50	1.90	4.00	5.66	8.00	9.80	12.65	14.97	17.89	530	1,000
	632.806	●	● ³	●	● ⁴		CC		CG	4.00	2.40	5.00	7.07	10.00	12.25	15.81	18.71	22.36	530	1,030
	632.846	●	● ³	●	● ⁴		CC		CG	4.50	2.40	6.25	8.84	12.50	15.31	19.76	23.38	27.94	540	1,050
632.886	●	● ³	●	● ⁴		CC		CG	5.00	3.10	8.00	11.31	16.00	19.60	25.30	29.94	35.78	540	1,060	
632.926	●	●	●					CG	5.50	3.60	10.00	14.14	20.00	24.49	31.62	37.41	44.72	540	1,070	
632.966	●	●	●					CG	6.00	3.90	12.50	17.68	25.00	30.62	39.53	46.77	55.90	540	1,070	
120°	632.187	●		●		CA	CC			0.35	0.20	–	0.06*	0.08	0.10	0.13	0.15	0.18	630	1,060
	632.217	●		●		CA	CC			0.40	0.20	–	0.08*	0.11	0.14	0.18	0.21	0.25	650	1,080
	632.247	●		●		CA	CC			0.50	0.20	–	0.12*	0.16	0.20	0.26	0.31	0.37	660	1,100
	632.277	●		●		CA	CC			0.60	0.30	–	0.16*	0.22	0.27	0.35	0.41	0.49	670	1,150
	632.307	●	●	●	●	CA	CC			0.70	0.30	0.16*	0.23*	0.32	0.39	0.51	0.60	0.72	710	1,240
	632.337	●	●	●	●	CA	CC			0.90	0.40	0.22*	0.32*	0.45	0.55	0.71	0.84	1.00	740	1,350
	632.367	●	●	●	●	CA	CC			1.00	0.50	0.31*	0.44*	0.63	0.77	1.00	1.18	1.40	800	1,430
	632.407	●	●	●	●	CA	CC			1.20	0.60	0.50*	0.71	1.00	1.23	1.58	1.87	2.24	830	1,480
	632.447	●	●	●	●	CA	CC			1.35	0.60	0.62*	0.88	1.25	1.53	1.98	2.34	2.80	840	1,520
	632.487	●	●	●	●	CA	CC			1.50	0.60	0.80*	1.13	1.60	1.96	2.53	2.99	3.58	850	1,540
	632.517	●	●	●	●	CA	CC			1.65	0.90	0.95*	1.34	1.90	2.32	3.00	3.55	4.24	850	1,560
	632.567	●	●	●	●	CA	CC			2.00	0.90	1.25	1.77	2.50	3.06	3.95	4.68	5.59	870	1,590
	632.607	●	●	●	●	CA	CC			2.20	1.10	1.57	2.23	3.15	3.86	4.98	5.89	7.04	870	1,620
	632.647	●	●	●			CC	CE		2.50	1.30	2.00	2.83	4.00	4.90	6.33	7.48	8.94	880	1,640
	632.677	●	●	●	● ⁴		CC	CE		2.70	1.40	2.37	3.36	4.75	5.82	7.51	8.89	10.62	890	1,660
	632.727	●	●	●	● ⁴		CC	CE		3.00	1.60	3.15	4.46	6.30	7.72	9.96	11.79	14.09	890	1,680
	632.767	●	●	●	● ⁴		CC	CE		3.50	1.70	4.00	5.66	8.00	9.80	12.65	14.97	17.89	900	1,700
632.807	●	● ³	●	● ⁴		CC		CG	4.00	2.00	5.00	7.07	10.00	12.25	15.81	18.71	22.36	900	1,710	
632.847	● ³	● ³	● ³	● ⁴		CC		CG	4.50	2.30	6.25	8.84	12.50	15.31	19.76	23.38	27.94	900	1,710	
632.887	●	●	●					CG	5.00	2.60	8.00	11.31	16.00	19.60	25.30	29.94	35.78	910	1,710	
632.927	●	●	●					CG	5.50	2.90	10.00	14.14	20.00	24.49	31.62	37.41	44.72	910	1,710	

* Differing spray pattern.

¹ We reserve the right to supply material 303 or 304 under material no. 16.

² We reserve the right to supply material 316Ti or 316L under material no. 17.

³ Only available with Code CG.

⁴ Only available with Code CC.

Conversion formula for this series: $\dot{V}_2 = \dot{V}_1 \cdot \sqrt{\frac{p_2}{p_1}}$

Ordering Type + Material no. + Code = Ordering no.
example: 632.216 + 16 + CA = 632.216.16.CA



Assembly accessories can be found in Chapter 9 "Accessories".

Low pressure flat fan nozzles

Series 610



Features:

- Uniform, parabolic liquid distribution
- Stable spray angle
- Compact design for narrow installation conditions

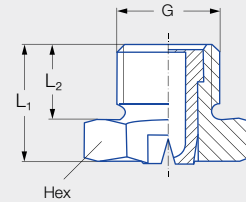

Applications:

- Spray cleaning
- Surface cleaning
- Strainer insert cleaning
- Coating processes
- Belt cleaning
- Lubrication processes

Series 610

G	Dimensions [mm]			Weight [g] Brass
	L ₁	L ₂	Hex	
1/8 BSPP	11.0	7.0	14	10.0

Spray angle	Ordering no.		Equivalent bore diameter A [mm]	Narrowest free cross section Ø [mm]	V̇ water [l/min]							Spray width B [mm] (at p = 5 bar)		
	Type	Mat. no.			p [bar]							H = 250 [mm]	H = 500 [mm]	
		16			30	0.5	1.0	2.0	3.0	5.0	7.0			10.0
20°	610.301	●	●	0.70	0.60	0.16*	0.23*	0.32	0.40	0.51	0.60	0.72	85	160
	610.361	●	●	1.00	0.80	0.32*	0.45*	0.63	0.77	1.00	1.18	1.41	85	160
	610.441	●	●	1.35	1.10	0.63*	0.89	1.25	1.53	1.98	2.34	2.80	85	160
	610.481	●	●	1.50	1.20	0.80*	1.13	1.60	1.96	2.53	2.99	3.58	85	160
30°	610.302	●	●	0.70	0.50	0.16*	0.23*	0.32	0.40	0.51	0.60	0.72	120	220
	610.362	●	●	1.00	0.70	0.32*	0.45*	0.63	0.77	1.00	1.18	1.41	120	220
	610.402	●	●	1.20	0.90	0.50*	0.71	1.00	1.22	1.58	1.87	2.23	120	230
	610.482	●	●	1.50	1.10	0.80*	1.13	1.60	1.96	2.53	2.99	3.58	130	230
	610.562	●	●	2.00	1.50	1.25	1.77	2.50	3.06	3.95	4.67	5.59	130	240
45°	610.303	●	●	0.70	0.50	0.16*	0.23*	0.32	0.40	0.51	0.60	0.72	170	330
	610.363	●	●	1.00	0.60	0.32*	0.45*	0.63	0.77	1.00	1.18	1.41	190	350
	610.403	●	●	1.20	0.90	0.50*	0.71	1.00	1.22	1.58	1.87	2.23	200	370
	610.483	●	●	1.50	1.10	0.80*	1.13	1.60	1.96	2.53	2.99	3.58	200	390
	610.563	●	●	2.00	1.40	1.25	1.77	2.50	3.06	3.95	4.67	5.59	210	410
	610.643	●	●	2.20	1.80	2.00	2.83	4.00	4.90	6.33	7.49	8.95	220	410





Spray angle	Ordering no.			Equivalent bore diameter A [mm]	Narrowest free cross section Ø [mm]	V̇ water [l/min]							Spray width B [mm] (at p = 5 bar)	
	Type	Mat. no.				p [bar]							H = 250 [mm]	H = 500 [mm]
		16	30			0.5	1.0	2.0	3.0	5.0	7.0	10.0		
		Stainless steel 303	Brass											
60°	610.304	●	●	0.70	0.40	0.16*	0.23*	0.32	0.40	0.51	0.60	0.72	260	480
	610.334	●	●	0.90	0.50	0.22*	0.32*	0.45	0.55	0.71	0.84	1.00	260	490
	610.364	●	●	1.00	0.60	0.32*	0.45*	0.63	0.77	1.00	1.18	1.41	260	500
	610.404	●	●	1.20	0.80	0.50*	0.71	1.00	1.22	1.58	1.87	2.23	260	510
	610.444	●	●	1.35	0.90	0.63*	0.89	1.25	1.53	1.98	2.34	2.80	260	510
	610.484	●	●	1.50	1.00	0.80*	1.13	1.60	1.96	2.53	2.99	3.58	260	520
	610.514	●	●	1.65	1.10	0.95*	1.34	1.90	2.32	3.00	3.55	4.24	270	520
	610.564	●	●	2.00	1.30	1.25	1.77	2.50	3.06	3.95	4.67	5.59	270	530
610.604	●	●	2.20	1.50	1.57	2.23	3.15	3.86	4.98	5.89	7.04	270	540	
75°	610.145	●	●	0.20	0.12	–	0.04*	0.05	0.06	0.08	0.09	0.11	380	690
	610.165	●	●	0.20	0.14	–	0.05*	0.06	0.08	0.10	0.12	0.14	380	690
	610.185	●	●	0.20	0.16	–	0.06*	0.08	0.10	0.13	0.15	0.18	380	690
	610.215	●	●	0.40	0.20	–	0.08*	0.11	0.14	0.18	0.21	0.25	380	690
	610.245	●	●	0.50	0.30	–	0.12*	0.16	0.20	0.26	0.31	0.37	380	690
	610.275	●	●	0.60	0.30	0.11*	0.16*	0.22	0.27	0.35	0.41	0.49	380	690
90°	610.216	●	●	0.40	0.20	–	0.08*	0.11	0.14	0.18	0.21	0.25	420	780
	610.276	●	●	0.60	0.30	0.11*	0.16*	0.22	0.27	0.35	0.41	0.49	430	790
	610.306	●	●	0.70	0.40	0.16*	0.23*	0.32	0.40	0.51	0.60	0.72	440	800
	610.336	●	●	0.90	0.50	0.22*	0.32*	0.45	0.55	0.71	0.84	1.00	440	820
	610.366	●	●	1.00	0.50	0.32*	0.45*	0.63	0.77	1.00	1.18	1.41	450	830
	610.406	●	●	1.20	0.70	0.50*	0.71	1.00	1.22	1.58	1.87	2.23	450	840
	610.446	●	●	1.35	0.80	0.63*	0.89	1.25	1.53	1.98	2.34	2.80	460	860
	610.486	●	●	1.50	0.80	0.80*	1.13	1.60	1.96	2.53	2.99	3.58	470	870
	610.516	●	●	1.65	0.90	0.95*	1.34	1.90	2.32	3.00	3.55	4.24	480	880
	610.566	●	●	2.00	1.10	1.25	1.77	2.50	3.06	3.95	4.67	5.59	490	900
	610.606	●	●	2.20	1.20	1.57	2.23	3.15	3.86	4.98	5.89	7.04	500	910
120°	610.187	●	●	0.35	0.20	–	0.06*	0.08	0.10	0.13	0.15	0.18	630	1,060
	610.217	●	●	0.40	0.20	–	0.08*	0.11	0.14	0.18	0.21	0.25	650	1,080
	610.247	●	●	0.50	0.20	–	0.12*	0.16	0.20	0.26	0.31	0.37	660	1,100
	610.277	●	●	0.60	0.30	–	0.16*	0.22	0.27	0.35	0.41	0.49	670	1,150
	610.307	●	●	0.70	0.30	0.16*	0.23*	0.32	0.40	0.51	0.60	0.72	710	1,240
	610.337	●	●	0.90	0.40	0.22*	0.32*	0.45	0.55	0.71	0.84	1.00	740	1,350
	610.367	●	●	1.00	0.50	0.32*	0.45*	0.63	0.77	1.00	1.18	1.41	800	1,430
	610.407	●	●	1.20	0.60	0.50*	0.71	1.00	1.22	1.58	1.87	2.23	830	1,480
	610.447	●	●	1.35	0.60	0.63*	0.89	1.25	1.53	1.98	2.34	2.80	840	1,520
	610.487	●	●	1.50	0.60	0.80*	1.13	1.60	1.96	2.53	2.99	3.58	850	1,540
	610.517	●	●	1.65	0.90	0.95*	1.34	1.90	2.32	3.00	3.55	4.24	850	1,560
	610.567	●	●	2.00	0.90	1.25	1.77	2.50	3.06	3.95	4.67	5.59	870	1,590
	610.607	●	●	2.20	1.10	1.57	2.23	3.15	3.86	4.98	5.89	7.04	870	1,620

* Differing spray pattern.

Conversion formula for this series: $\dot{V}_2 = \dot{V}_1 \cdot \sqrt{\frac{p_2}{p_1}}$

Ordering Type + Material no. = Ordering no.
example: 610.304 + 16 = 610.304.16

 Assembly accessories can be found in Chapter 9 "Accessories".

Low pressure flat fan nozzles Series 612

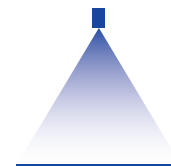

Features:

- Uniform, parabolic liquid distribution
- Stable spray angle
- Compact design for narrow installation conditions

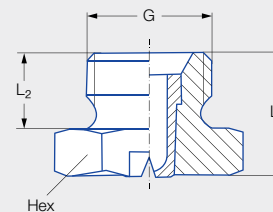

Applications:

- Spray cleaning
- Surface cleaning
- Strainer insert cleaning
- Coating processes
- Belt cleaning
- Lubrication processes

Series 612

G	Dimensions [mm]			Weight [g] Brass
	L ₁	L ₂	Hex	
1/4 BSPP	13.0	8.0	17	14.0

Spray angle	Ordering no.				Equivalent bore diameter A [mm]	Narrowest free cross section Ø [mm]	V̇ water [l/min]							Spray width B [mm] (at p = 5 bar)	
	Type	Mat. no.					p [bar]							H = 250 [mm]	H = 500 [mm]
		16	17 ¹	30			0.5	1.0	2.0	3.0	5.0	7.0	10.0		
20°	612.301	●	●	●	0.70	0.60	0.16*	0.23*	0.32	0.40	0.51	0.60	0.72	85	160
	612.361	●	●	●	1.00	0.80	0.32*	0.45*	0.63	0.77	1.00	1.18	1.41	85	160
	612.441	●	●	●	1.30	1.10	0.63*	0.89	1.25	1.53	1.98	2.34	2.80	85	160
	612.481	●	●	●	1.50	1.20	0.80*	1.13	1.60	1.96	2.53	2.99	3.58	85	160
30°	612.302	●	●	●	0.60	0.50	0.16*	0.23*	0.32	0.40	0.51	0.60	0.72	120	220
	612.362	●	●	●	1.00	0.70	0.32*	0.45*	0.63	0.77	1.00	1.18	1.41	120	220
	612.402	●	●	●	1.20	0.90	0.50*	0.71	1.00	1.22	1.58	1.87	2.23	120	230
	612.482	●	●	●	1.50	1.10	0.80*	1.13	1.60	1.96	2.53	2.99	3.58	130	230
	612.562	●	●	●	2.00	1.50	1.25	1.77	2.50	3.06	3.95	4.67	5.59	130	240
	612.642	●	●	●	2.50	1.80	2.00	2.83	4.00	4.90	6.33	7.49	8.95	140	250
	612.722	●	●	●	3.00	2.40	3.15	4.45	6.30	7.71	9.96	11.78	14.09	140	260
	612.762	●	●	●	3.50	2.70	4.00	5.66	8.00	9.80	12.65	14.97	17.89	140	260
45°	612.303	●	●	●	0.70	0.50	0.16*	0.23*	0.32	0.40	0.51	0.60	0.72	170	330
	612.363	●	●	●	1.00	0.60	0.32*	0.45*	0.63	0.77	1.00	1.18	1.41	190	350
	612.403	●	●	●	1.20	0.90	0.50*	0.71	1.00	1.22	1.58	1.87	2.23	200	370
	612.483	●	●	●	1.50	1.10	0.80*	1.13	1.60	1.96	2.53	2.99	3.58	200	390
	612.563	●	●	●	2.00	1.40	1.25	1.77	2.50	3.06	3.95	4.67	5.59	210	410
	612.643	●	●	●	2.50	1.80	2.00	2.83	4.00	4.90	6.33	7.49	8.95	220	410
	612.723	●	●	●	3.00	2.40	3.15	4.45	6.30	7.71	9.96	11.78	14.09	220	420
	612.763	●	●	●	3.50	2.60	4.00	5.66	8.00	9.80	12.65	14.97	17.89	220	420
612.803	●	●	●	4.00	3.00	5.00	7.07	10.00	12.25	15.81	18.71	22.36	220	420	



Spray angle	Ordering no.				Equivalent bore diameter A [mm]	Narrowest free cross section Ø [mm]	V̇ water [l/min]							Spray width B [mm] (at p = 5 bar)	
	Type	Mat. no.					p [bar]							H = 250 [mm]	H = 500 [mm]
		16	17 ¹	30			0.5	1.0	2.0	3.0	5.0	7.0	10.0		
		Stainless steel 303	Stainless steel 316Ti/ Stainless steel 316L	Brass											
60°	612.304	●	●	●	0.70	0.40	0.16*	0.23*	0.32	0.40	0.51	0.60	0.72	260	480
	612.334	●	●	●	0.90	0.50	0.22*	0.32*	0.45	0.55	0.71	0.84	1.00	260	490
	612.364	●	●	●	1.00	0.60	0.32*	0.45*	0.63	0.77	1.00	1.18	1.41	260	500
	612.404	●	●	●	1.20	0.80	0.50*	0.71	1.00	1.22	1.58	1.87	2.23	260	510
	612.444	●	●	●	1.35	0.90	0.63*	0.89	1.25	1.53	1.98	2.34	2.80	260	510
	612.484	●	●	●	1.50	1.00	0.80*	1.13	1.60	1.96	2.53	2.99	3.58	260	520
	612.514	●	●	●	1.65	1.10	0.95*	1.34	1.90	2.32	3.00	3.55	4.24	270	520
	612.564	●	●	●	2.00	1.30	1.25	1.77	2.50	3.06	3.95	4.67	5.59	270	530
	612.604	●	●	●	2.20	1.50	1.57	2.23	3.15	3.86	4.98	5.89	7.04	270	540
	612.644	●	●	●	2.50	1.60	2.00	2.83	4.00	4.90	6.33	7.49	8.95	270	540
	612.674	●	●	●	2.70	1.80	2.37	3.36	4.75	5.82	7.51	8.89	10.62	270	550
	612.724	●	●	●	3.00	2.10	3.15	4.45	6.30	7.71	9.96	11.78	14.09	280	560
	612.764	●	●	●	3.50	2.30	4.00	5.66	8.00	9.80	12.65	14.97	17.89	280	570
612.804	●	●	●	4.00	2.60	5.00	7.07	10.00	12.25	15.81	18.71	22.36	290	580	
612.884	●	●	●	5.00	3.40	8.00	11.31	16.00	19.60	25.30	29.94	35.78	290	580	
75°	612.145	●		●	0.20	0.12	–	0.04*	0.05	0.06	0.08	0.09	0.11	380	690
	612.165	●		●	0.20	0.14	–	0.05*	0.07	0.08	0.10	0.12	0.15	380	690
	612.185	●		●	0.20	0.16	–	0.06*	0.08	0.10	0.13	0.15	0.18	380	690
	612.215	●		●	0.40	0.20	–	0.08*	0.11	0.14	0.18	0.21	0.25	380	690
	612.245	●		●	0.50	0.30	–	0.12*	0.16	0.20	0.26	0.31	0.37	380	690
	612.275	●		●	0.60	0.30	0.11*	0.16	0.22	0.27	0.35	0.41	0.49	380	690
90°	612.216	●		●	0.40	0.20	–	0.08*	0.11	0.14	0.18	0.21	0.25	420	780
	612.276	●		●	0.60	0.30	0.11*	0.16*	0.22	0.27	0.35	0.41	0.49	430	790
	612.306	●	●	●	0.70	0.40	0.16*	0.23*	0.32	0.40	0.51	0.60	0.72	440	800
	612.336	●	●	●	0.90	0.50	0.22*	0.32*	0.45	0.55	0.71	0.84	1.00	440	820
	612.366	●	●	●	1.00	0.50	0.32*	0.45*	0.63	0.77	1.00	1.18	1.41	450	830
	612.406	●	●	●	1.20	0.70	0.50*	0.71	1.00	1.22	1.58	1.87	2.23	450	840
	612.446	●	●	●	1.35	0.80	0.63*	0.89	1.25	1.53	1.98	2.34	2.80	460	860
	612.486	●	●	●	1.50	0.80	0.80*	1.13	1.60	1.96	2.53	2.99	3.58	470	870
	612.516	●	●	●	1.65	0.90	0.95*	1.34	1.90	2.32	3.00	3.55	4.24	480	880
	612.566	●	●	●	2.00	1.10	1.25	1.77	2.50	3.06	3.95	4.67	5.59	490	900
	612.606	●	●	●	2.20	1.20	1.57	2.23	3.15	3.86	4.98	5.89	7.04	500	910
	612.646	●	●	●	2.50	1.30	2.00	2.83	4.00	4.90	6.33	7.49	8.95	510	930
	612.676	●	●	●	2.70	1.40	2.37	3.36	4.75	5.82	7.51	8.89	10.62	510	950
	612.726	●	●	●	3.00	1.70	3.15	4.45	6.30	7.71	9.96	11.78	14.09	520	980
	612.766	●	●	●	3.50	1.90	4.00	5.66	8.00	9.80	12.65	14.97	17.89	530	1,000
612.806	●	●	●	4.00	2.40	5.00	7.07	10.00	12.25	15.81	18.71	22.36	530	1,030	

Spray angle	Ordering no.				Equivalent bore diameter A [mm]	Narrowest free cross section Ø [mm]	V̇ water [l/min]						Spray width B [mm] (at p = 5 bar)		
	Type	Mat. no.					p [bar]								
		16	17 ¹	30											
		Stainless steel 303	Stainless steel 316Ti/ Stainless steel 316L	Brass			0.5	1.0	2.0	3.0	5.0	7.0	10.0	H = 250 [mm]	H = 500 [mm]
120°	612.187	●		●	0.35	0.20	–	0.06*	0.08	0.10	0.13	0.15	0.18	630	1,060
	612.217	●		●	0.40	0.20	–	0.08*	0.11	0.14	0.18	0.21	0.25	650	1,080
	612.247	●		●	0.50	0.20	–	0.12*	0.16	0.20	0.26	0.31	0.37	660	1,100
	612.277	●		●	0.60	0.30	0.11*	0.16*	0.22	0.27	0.35	0.41	0.49	670	1,150
	612.307	●		●	0.70	0.30	0.16*	0.23*	0.32	0.40	0.51	0.60	0.72	710	1,240
	612.337	●	●	●	0.90	0.40	0.22*	0.32*	0.45	0.55	0.71	0.84	1.00	740	1,350
	612.367	●	●	●	1.00	0.40	0.32*	0.45*	0.63	0.77	1.00	1.18	1.41	800	1,430
	612.407	●	●	●	1.20	0.60	0.50*	0.71	1.00	1.22	1.58	1.87	2.23	830	1,480
	612.447	●	●	●	1.35	0.60	0.63*	0.89	1.25	1.53	1.98	2.34	2.80	840	1,520
	612.487	●	●	●	1.50	0.60	0.80*	1.13	1.60	1.96	2.53	2.99	3.58	850	1,540
	612.517	●	●	●	1.65	0.90	0.95*	1.34	1.90	2.32	3.00	3.55	4.24	850	1,560
	612.567	●	●	●	2.00	0.90	1.25	1.77	2.50	3.06	3.95	4.67	5.59	870	1,590
	612.607	●	●	●	2.20	1.10	1.57	2.23	3.15	3.86	4.98	5.89	7.04	870	1,620
	612.647	●	●	●	2.50	1.30	2.00	2.83	4.00	4.90	6.33	7.49	8.95	880	1,640
	612.677	●	●	●	2.70	1.40	2.37	3.36	4.75	5.82	7.51	8.89	10.62	890	1,660
	612.727	●	●	●	3.00	1.60	3.15	4.45	6.30	7.71	9.96	11.78	14.09	890	1,680
612.767	●	●	●	3.50	1.70	4.00	5.66	8.00	9.80	12.65	14.97	17.89	900	1,700	
612.807	●		●	4.00	2.00	5.00	7.07	10.00	12.25	15.81	18.71	22.36	900	1,710	

* Differing spray pattern.

¹ We reserve the right to supply material 316Ti or 316L under material no. 17.

Conversion formula for this series: $\dot{V}_2 = \dot{V}_1 \cdot \sqrt{\frac{p_2}{p_1}}$

Ordering Type + Material no. = Ordering no.
example: 612.187 + 16 = 612.187.16



Assembly accessories can be found in Chapter 9 "Accessories".

Low pressure flat fan nozzles

Series 616/617

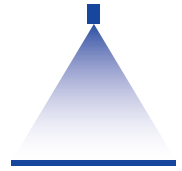

Features:

- Uniform, parabolic liquid distribution
- Stable spray angle
- Compact design for narrow installation conditions

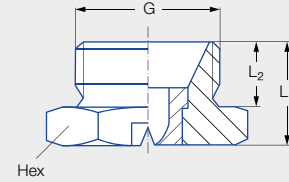

Applications:

- Spray cleaning
- Surface cleaning
- Filter cleaning
- Coating processes
- Belt cleaning
- Lubrication processes

Series 616/617

G	Dimensions [mm]			Weight [g] Brass
	L ₁	L ₂	Hex	
3/4 BSPP	19.0	12.0	32	75.0

Spray angle	Ordering no.				Equivalent bore diameter A [mm]	Narrowest free cross section Ø [mm]	V̇ water [l/min]						Spray width B [mm] (at p = 5 bar)		
	Type	Mat. no.					p [bar]						H = 250 [mm]	H = 500 [mm]	
		16	17'	30			0.5	1.0	2.0	3.0	5.0	7.0			10.0
20°	616.721	●	●	●	3.00	2.50	3.15	4.45	6.30	7.71	9.96	11.78	14.09	100	180
	616.801	●	●	●	4.00	3.20	5.00	7.07	10.00	12.25	15.81	18.71	22.36	100	180
	616.881	●	●	●	5.00	4.00	8.00	11.31	16.00	19.60	25.30	29.94	35.78	100	180
	616.921	●	●	●	5.50	4.40	10.00	14.14	20.00	24.49	31.62	37.41	44.72	100	180
	616.961	●	●	●	6.00	5.10	12.50	17.68	25.00	30.62	39.53	46.77	55.90	100	180
30°	616.722	●	●	●	3.00	2.50	3.15	4.45	6.30	7.71	9.96	11.78	14.09	140	260
	616.762	●	●	●	3.50	2.80	4.00	5.66	8.00	9.80	12.65	14.97	17.89	140	260
	616.802	●	●	●	4.00	3.10	5.00	7.07	10.00	12.25	15.81	18.71	22.36	140	260
	616.882	●	●	●	5.00	4.00	8.00	11.31	16.00	19.60	25.30	29.94	35.78	140	270
	616.922	●	●	●	5.50	4.40	10.00	14.14	20.00	24.49	31.62	37.41	44.72	140	270
616.962	●	●	●	6.00	5.00	12.50	17.68	25.00	30.62	39.53	46.77	55.90	140	270	
45°	616.723	●	●	●	3.00	2.40	3.15	4.45	6.30	7.71	9.96	11.78	14.09	220	420
	616.763	●	●	●	3.50	2.60	4.00	5.66	8.00	9.80	12.65	14.97	17.89	220	420
	616.803	●	●	●	4.00	3.00	5.00	7.07	10.00	12.25	15.81	18.71	22.36	220	420
	616.843	●	●	●	4.50	3.40	6.25	8.84	12.50	15.31	19.76	23.38	27.94	220	420
	616.883	●	●	●	5.00	3.80	8.00	11.31	16.00	19.60	25.30	29.94	35.78	220	420
	616.923	●	●	●	5.50	4.20	10.00	14.14	20.00	24.49	31.62	37.41	44.72	220	430
616.963	●	●	●	6.00	4.40	12.50	17.68	25.00	30.62	39.53	46.77	55.90	220	430	

Spray angle	Ordering no.				Equivalent bore diameter A [mm]	Narrowest free cross section Ø [mm]	V̇ water [l/min]							Spray width B [mm] (at p = 5 bar)	
	Type	Mat. no.					p [bar]							H = 250 [mm]	H = 500 [mm]
		16	17 ¹	30			0.5	1.0	2.0	3.0	5.0	7.0	10.0		
		Stainless steel 303	Stainless steel 316Ti/ Stainless steel 316L	Brass											
60°	616.724	●	●	●	3.00	2.10	3.15	4.45	6.30	7.71	9.96	11.78	14.09	280	560
	616.764	●	●	●	3.50	2.30	4.00	5.66	8.00	9.80	12.65	14.97	17.89	280	570
	616.804	●	●	●	4.00	2.60	5.00	7.07	10.00	12.25	15.81	18.71	22.36	290	580
	616.844	●	●	●	4.50	3.00	6.25	8.84	12.50	15.31	19.76	23.38	27.94	290	580
	616.884	●	●	●	5.00	3.40	8.00	11.31	16.00	19.60	25.30	29.94	35.78	290	580
	616.924	●	●	●	5.50	4.10	10.00	14.14	20.00	24.49	31.62	37.41	44.72	290	580
	616.964	●	●	●	6.00	4.20	12.50	17.68	25.00	30.62	39.53	46.77	55.90	290	580
	617.044	●		●	8.00	5.50	20.00	28.26	39.97	48.95	63.20	74.78	89.38	290	580
	617.124			●	10.00	7.40	31.50	44.54	62.99	77.15	99.60	117.85	140.86	290	580
90°	616.726	●	●	●	3.00	1.80	3.15	4.45	6.30	7.71	9.96	11.78	14.09	520	980
	616.766	●	●	●	3.50	1.90	4.00	5.66	8.00	9.80	12.65	14.97	17.89	530	1,000
	616.806	●	●	●	4.00	2.40	5.00	7.07	10.00	12.25	15.81	18.71	22.36	530	1,030
	616.846	●	●	●	4.50	2.40	6.25	8.84	12.50	15.31	19.76	23.38	27.94	540	1,050
	616.886	●	●	●	5.00	3.10	8.00	11.31	16.00	19.60	25.30	29.94	35.78	540	1,060
	616.926	●	●	●	5.50	3.60	10.00	14.14	20.00	24.49	31.62	37.41	44.72	540	1,070
	616.966	●	●	●	6.00	3.90	12.50	17.68	25.00	30.62	39.53	46.77	55.90	540	1,070
120°	616.727	●	●	●	3.00	1.60	3.15	4.45	6.30	7.71	9.96	11.78	14.09	890	1,680
	616.767	●	●	●	3.50	1.70	4.00	5.66	8.00	9.80	12.65	14.97	17.89	900	1,700
	616.807	●	●	●	4.00	2.00	5.00	7.07	10.00	12.25	15.81	18.71	22.36	900	1,710
	616.887	●	●	●	5.00	2.60	8.00	11.31	16.00	19.60	25.30	29.94	35.78	910	1,710
	616.927	●	●	●	5.50	2.90	10.00	14.14	20.00	24.49	31.62	37.41	44.72	910	1,710
	616.967			●	6.00	3.20	12.50	17.68	25.00	30.62	39.53	46.77	55.90	910	1,710
	617.047			●	8.00	4.40	20.00	28.26	39.97	48.95	63.20	74.78	89.38	910	1,710

¹ We reserve the right to supply material 316Ti or 316L under material no. 17.

Conversion formula for this series: $\dot{V}_2 = \dot{V}_1 \cdot \sqrt{\frac{p_2}{p_1}}$

Ordering Type + Material no. = Ordering no.
example: 616.724 + 16 = 616.724.16



Assembly accessories can be found in Chapter 9 "Accessories".

Low pressure flat fan nozzles for retaining nut Series 652

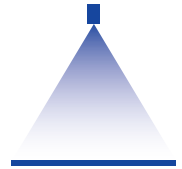

Features:

- Uniform, parabolic liquid distribution
- Stable spray angle
- Assembly with retaining nut

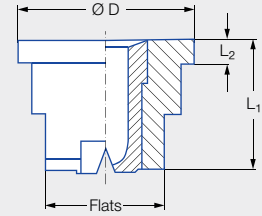

Applications:

- Spray cleaning
- Surface cleaning
- Filter cleaning
- Coating processes
- Belt cleaning
- Lubrication processes

Series 652

Code	Dimensions [mm]				Weight [g] Brass
	L ₁	L ₂	Ø D	Flats	
Assembly with retaining nut 3/8 BSPP	11.0	2.0	14.8	10	9.0

Spray angle	Ordering no.	Mat. no.					Equivalent bore diameter A [mm]	Narrowest free cross section Ø [mm]	V̇ water [l/min]						Spray width B [mm] (at p = 5 bar)	
		16	17'	30	5E	p [bar]						H = 250 [mm]	H = 500 [mm]			
						0.5			1.0	2.0	3.0			5.0	10.0	
20°	652.301	●	●	●	●	0.70	0.60	0.16*	0.23*	0.32	0.40	0.51	0.72	85	160	
	652.361	●	●	●	●	1.00	0.80	0.32*	0.45*	0.63	0.77	1.00	1.41	85	160	
	652.441	●	●	●	●	1.35	1.10	0.63*	0.89	1.25	1.53	1.98	2.80	85	160	
	652.481	●	●	●	●	1.50	1.20	0.80*	1.13	1.60	1.96	2.53	3.58	85	160	
30°	652.302	●	●	●	●	0.60	0.50	0.16*	0.23*	0.32	0.40	0.51	0.72	120	220	
	652.362	●	●	●	●	1.00	0.70	0.32*	0.45*	0.63	0.77	1.00	1.41	120	220	
	652.402	●	●	●	●	1.20	0.90	0.50*	0.71	1.00	1.22	1.58	2.23	120	230	
	652.482	●	●	●	●	1.50	1.10	0.80*	1.13	1.60	1.96	2.53	3.58	130	230	
	652.562	●	●	●	●	2.00	1.50	1.25	1.77	2.50	3.06	3.95	5.59	130	240	
	652.642	●	●	●	●	2.50	1.80	2.00	2.83	4.00	4.90	6.33	8.95	140	250	
	652.722	●	●	●	●	3.00	2.40	3.15	4.45	6.30	7.71	9.96	14.09	140	260	
	652.762	●	●	●	●	3.50	2.70	4.00	5.66	8.00	9.80	12.65	17.89	140	260	
652.802	●	●	●	●	4.00	3.10	5.00	7.07	10.00	12.25	15.81	22.36	140	260		
45°	652.303	●	●	●	●	0.70	0.50	0.16*	0.23*	0.32	0.40	0.51	0.72	170	330	
	652.363	●	●	●	●	1.00	0.60	0.32*	0.45*	0.63	0.77	1.00	1.41	190	350	
	652.403	●	●	●	●	1.20	0.90	0.50*	0.71	1.00	1.22	1.58	2.23	200	370	
	652.483	●	●	●	●	1.50	1.10	0.80*	1.13	1.60	1.96	2.53	3.58	200	390	
	652.563	●	●	●	●	2.00	1.40	1.25	1.77	2.50	3.06	3.95	5.59	210	410	
	652.643	●	●	●	●	2.50	1.80	2.00	2.83	4.00	4.90	6.33	8.95	220	410	
	652.723	●	●	●	●	3.00	2.40	3.15	4.45	6.30	7.71	9.96	14.09	220	420	
	652.763	●	●	●	●	3.50	2.60	4.00	5.66	8.00	9.80	12.65	17.89	220	420	
652.803	●	●	●	●	4.00	3.00	5.00	7.07	10.00	12.25	15.81	22.36	220	420		

Spray angle	Ordering no.					Equivalent bore diameter A [mm]	Narrowest free cross section Ø [mm]	V̇ water [l/min]						Spray width B [mm] (at p = 5 bar)	
	Type	Mat. no.						p [bar]						H = 250 [mm]	H = 500 [mm]
		16	17 ¹	30	5E			0.5	1.0	2.0	3.0	5.0	10.0		
		Stainless steel 303	Stainless steel 316Ti/ Stainless steel 316L	Brass	PVDF										
60°	652.304	●	●	●	●	0.70	0.40	0.16*	0.23*	0.32	0.40	0.51	0.72	260	480
	652.334	●	●	●	●	0.90	0.50	0.22*	0.32*	0.45	0.55	0.71	1.00	260	490
	652.364	●	●	●	●	1.00	0.60	0.32*	0.45*	0.63	0.77	1.00	1.41	260	500
	652.404	●	●	●	●	1.20	0.80	0.50*	0.71	1.00	1.22	1.58	2.23	260	510
	652.444	●	●	●	●	1.35	0.90	0.63*	0.89	1.25	1.53	1.98	2.80	260	510
	652.484	●	●	●	●	1.50	1.00	0.80*	1.13	1.60	1.96	2.53	3.58	260	520
	652.514	●	●	●	●	1.65	1.10	0.95*	1.34	1.90	2.32	3.00	4.24	270	520
	652.564	●	●	●	●	2.00	1.30	1.25	1.77	2.50	3.06	3.95	5.59	270	530
	652.604	●	●	●	●	2.20	1.50	1.57	2.23	3.15	3.86	4.98	7.04	270	540
	652.644	●	●	●	●	2.50	1.60	2.00	2.83	4.00	4.90	6.33	8.95	270	540
	652.674	●	●	●	●	2.70	1.80	2.37	3.36	4.75	5.82	7.51	10.62	270	550
	652.724	●	●	●	●	3.00	2.10	3.15	4.45	6.30	7.71	9.96	14.09	280	560
	652.764	●	●	●	●	3.50	2.30	4.00	5.66	8.00	9.80	12.65	17.89	280	570
	652.804	●	●	●	●	4.00	2.60	5.00	7.07	10.00	12.25	15.81	22.36	290	580
	652.844	●	●	●	●	4.50	3.00	6.25	8.84	12.50	15.31	19.76	27.94	290	580
652.884	●	●	●	●	5.00	3.40	8.00	11.31	16.00	19.60	25.30	35.78	290	580	
75°	652.145	●	●	●	●	0.20	0.12	–	0.04*	0.05	0.06	0.08	0.11	380	690
	652.165	●	●	●	●	0.20	0.14	–	0.05*	0.07	0.08	0.10	0.14	380	690
	652.185	●	●	●	●	0.20	0.16	–	0.06*	0.08	0.10	0.13	0.18	380	690
	652.215	●	●	●	●	0.40	0.20	–	0.08*	0.11	0.14	0.18	0.25	380	690
	652.245	●	●	●	●	0.50	0.30	–	0.12*	0.16	0.20	0.26	0.37	380	690
	652.275	●	●	●	●	0.60	0.30	0.11*	0.16*	0.22	0.27	0.35	0.49	380	690
90°	652.216	●	●	●	●	0.40	0.20	0.06*	0.08*	0.11	0.14	0.18	0.25	420	780
	652.246	●	●	●	●	0.50	0.30	0.08*	0.12*	0.16	0.20	0.26	0.37	420	780
	652.276	●	●	●	●	0.60	0.30	0.11*	0.16*	0.22	0.27	0.35	0.49	430	790
	652.306	●	●	●	●	0.70	0.40	0.16*	0.23*	0.32	0.40	0.51	0.72	440	800
	652.336	●	●	●	●	0.90	0.50	0.22*	0.32*	0.45	0.55	0.71	1.00	440	820
	652.366	●	●	●	●	1.00	0.50	0.32*	0.45*	0.63	0.77	1.00	1.41	450	830
	652.406	●	●	●	●	1.20	0.70	0.50*	0.71	1.00	1.22	1.58	2.23	450	840
	652.446	●	●	●	●	1.35	0.80	0.63*	0.89	1.25	1.53	1.98	2.80	460	860
	652.486	●	●	●	●	1.50	0.80	0.80*	1.13	1.60	1.96	2.53	3.58	470	870
	652.516	●	●	●	●	1.65	0.90	0.95*	1.34	1.90	2.32	3.00	4.24	480	880
	652.566	●	●	●	●	2.00	1.10	1.25	1.77	2.50	3.06	3.95	5.59	490	900
	652.606	●	●	●	●	2.20	1.20	1.57	2.23	3.15	3.86	4.98	7.04	500	910
	652.646	●	●	●	●	2.50	1.30	2.00	2.83	4.00	4.90	6.33	8.95	510	930
	652.676	●	●	●	●	2.70	1.40	2.37	3.36	4.75	5.82	7.51	10.62	510	950
	652.726	●	●	●	●	3.00	1.70	3.15	4.45	6.30	7.71	9.96	14.09	520	980
	652.766	●	●	●	●	3.50	1.90	4.00	5.66	8.00	9.80	12.65	17.89	530	1,000
	652.806	●	●	●	●	4.00	2.40	5.00	7.07	10.00	12.25	15.81	22.36	530	1,030
	652.846	●	●	●	●	4.50	2.40	6.25	8.84	12.50	15.31	19.76	27.94	540	1,050
652.886	●	●	●	●	5.00	3.10	8.00	11.31	16.00	19.60	25.30	35.78	540	1,060	





Spray angle	Ordering no.					Equivalent bore diameter A [mm]	Narrowest free cross section Ø [mm]	V̇ water [l/min]						Spray width B [mm] (at p = 5 bar)	
	Type	Mat. no.						p [bar]						H = 250 [mm]	H = 500 [mm]
		16	17 ¹	30	5E			0.5	1.0	2.0	3.0	5.0	10.0		
		Stainless steel 303	Stainless steel 316Ti/ Stainless steel 316L	Brass	PVDF										
120°	652.187	●		●		0.35	0.20	–	0.06*	0.08	0.10	0.13	0.18	630	1,060
	652.217	●		●		0.40	0.20	–	0.08*	0.11	0.14	0.18	0.25	650	1,080
	652.247	●		●		0.50	0.20	–	0.12*	0.16	0.20	0.26	0.37	660	1,100
	652.277	●		●		0.60	0.30	–	0.16*	0.22	0.27	0.35	0.49	670	1,150
	652.307	●		●	●	0.70	0.30	0.16*	0.23*	0.32	0.40	0.51	0.72	710	1,240
	652.337	●	●	●	●	0.90	0.40	0.22*	0.32*	0.45	0.55	0.71	1.00	740	1,350
	652.367	●	●	●	●	1.00	0.50	0.32*	0.45*	0.63	0.77	1.00	1.41	800	1,430
	652.407	●	●	●	●	1.20	0.60	0.50*	0.71	1.00	1.22	1.58	2.23	830	1,480
	652.447	●	●	●	●	1.35	0.60	0.63*	0.89	1.25	1.53	1.98	2.80	840	1,520
	652.487	●	●	●	●	1.50	0.60	0.80*	1.13	1.60	1.96	2.53	3.58	850	1,540
	652.517	●	●	●	●	1.65	0.90	0.95*	1.34	1.90	2.32	3.00	4.24	850	1,560
	652.567	●	●	●	●	2.00	0.90	1.25	1.77	2.50	3.06	3.95	5.59	870	1,590
	652.607	●	●	●	●	2.20	1.10	1.57	2.23	3.15	3.86	4.98	7.04	870	1,620
	652.647	●	●	●		2.50	1.30	2.00	2.83	4.00	4.90	6.33	8.95	880	1,640
	652.677	●	●	●		2.70	1.40	2.37	3.36	4.75	5.82	7.51	10.62	890	1,660
	652.727	●	●	●	●	3.00	1.60	3.15	4.45	6.30	7.71	9.96	14.09	890	1,680
	652.767	●	●	●		3.50	1.70	4.00	5.66	8.00	9.80	12.65	17.89	900	1,700
	652.807	●		●		4.00	2.00	5.00	7.07	10.00	12.25	15.81	22.36	900	1,710
652.847				●	4.50	2.30	6.25	8.84	12.50	15.31	19.76	27.94	900	1,710	
652.887				●	5.00	2.60	8.00	11.31	16.00	19.60	25.30	35.78	910	1,710	

* Differing spray pattern.

¹ We reserve the right to supply material 316Ti or 316L under material no. 17.

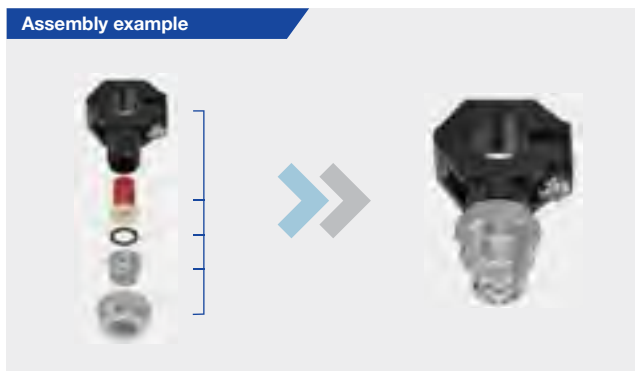

Conversion formula for this series: $\dot{V}_2 = \dot{V}_1 \cdot \sqrt{\frac{p_2}{p_1}}$

Ordering Type + Material no. = Ordering no.
example: 652.187 + 16 = 652.187.16

Assembly accessories can be found in Chapter 9 "Accessories".

Low pressure flat fan nozzles

Belt lubrication

Series 652

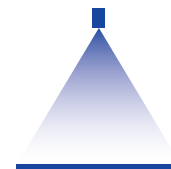

Features:

- Particularly low flow rate
- Parabolic liquid distribution
- Assembly with retaining nut

Applications:

- Belt lubrication
- Spraying on food products
- Moistening of rollers
- Oiling of metal sheets



Series 652.xxx.56.03

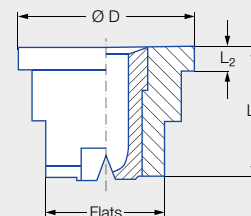



Code	Material	Dimensions [mm]				Weight [g]
		L ₁	L ₂	Ø D	Flats	
Assembly with retaining nut 3/8 BSPP	Stainless steel 303	11.0	2.0	14.8	10	10.0
	POM/Stainless steel	12.0	2.0	14.8	8	3.0
	POM	11.0	2.0	15.0	8	2.0

Spray angle	Ordering no.				Color	Narrowest free cross section Ø [mm]	V̇ water [l/min]			
	Type	Mat. no.					p [bar]			
		16	8H.03	56.03						
		Stainless steel 303	Housing: POM Insert: 303 SS	POM			1.0	2.0	3.0	5.0
75°	652.145	●	●	●	Green	0.12	0.04*	0.05	0.06	0.08
	652.165	●	●		Black	0.14	0.05*	0.07	0.08	0.10
	652.185	●	●	●	Red	0.16	0.06*	0.08	0.10	0.13
	652.215	●	●	●	Blue	0.20	0.08*	0.11	0.14	0.18
	652.245	●	●	●	Orange	0.30	0.12*	0.16	0.20	0.26
120°	652.275	●	●		Brown	0.30	0.16*	0.22	0.27	0.35
	652.187	●	●		Grey	0.20	0.06*	0.08	0.10	0.13
	652.247	●	●		Black	0.20	0.12*	0.16	0.20	0.26
	652.277	●	●		Black	0.30	0.16*	0.22	0.27	0.35

* Differing spray pattern.

Accessories:

Designation	Ordering no.	Material	Color	Pressure [bar]		G BSPP	Dimensions [mm]						Mesh size [mm]
				Opening	Closing		H ₁	H ₂	Ø D	Ø D ₁	Ø D ₂	Hex	
 Filter with non-return valve	095.016.53.11.00	PP	Blue	0.50	0.30	-	21.00	1.60	-	15.00	11.00	-	0.08
	095.016.53.14.63	PP	Green	2.80	1.60	-	21.00	1.50	-	15.00	11.00	-	0.08
 Flat gas-gasket	065.240.55	PTFE	-	-	-	-	-	-	-	-	-	-	-
	065.240.72	EWP 210	-	-	-	-	-	-	-	-	-	-	-
 Retaining nut	065.200.16	Stainless steel 303	-	-	-	3/8	13.00	10.00	12.80	-	-	22	-
	065.200.56	POM	Black	-	-	3/8	14.50	11.50	13.00	-	-	22	-

Conversion formula for this series: $\dot{V}_2 = \dot{V}_1 \cdot \sqrt{\frac{p_2}{p_1}}$

Ordering Type + Material no. = Ordering no.
 example: 652.145 + 16 = 652.145.16

Assembly accessories can be found in Chapter 9 "Accessories".

Low pressure flat fan nozzles

Press-in nozzle

Series 612.xxx.5E.03

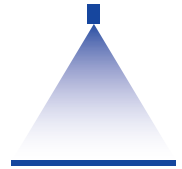

Features:

- Uniform, parabolic liquid distribution
- For pressing into pipes

Applications:

- Cleaning and rinsing procedures
- Industrial dish washers

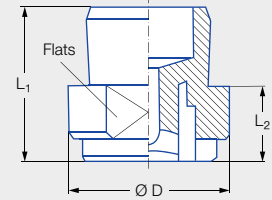

Series 612.xxx.5E.03

Dimensions [mm]				Weight [g]
L ₁	L ₂	Ø D	Flats	
12.5	5.5	14.0	12	2.0

Spray angle	Ordering no.		Equivalent bore diameter A [mm]	Narrowest free cross section Ø [mm]	V̇ water [l/min]						Spray width B [mm] (at p = 2 bar)	
	Type	Mat. no.			p [bar]						H = 250 [mm]	H = 500 [mm]
		5E.03			0.3	0.5	0.7	1.0	1.5	2.0		
90°	612.366	●	1.00	0.50	0.24	0.31	0.37	0.44	0.55	0.63	360	730
	612.486	●	1.50	0.60	0.62	0.80	0.95	1.13	1.39	1.60	360	730
120°	612.487	●	1.50	0.60	0.62	0.80	0.95	1.13	1.39	1.60	720	1,280
	612.647	●	2.50	1.20	1.55	2.00	2.37	2.83	3.46	4.00	720	1,280

Assembly :

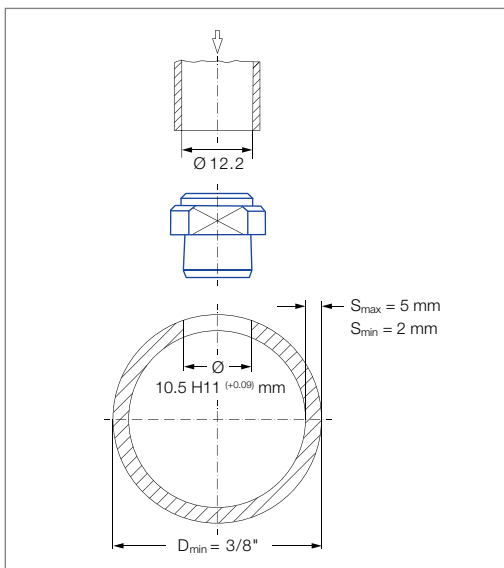

Drill pipe (Ø 10 mm), ream to Ø 10.5 H11 (+0.09) mm, adjust nozzle, place press-in pipe (inner diameter 12.2 mm) on nozzle and tap in using a rubber mallet. Max. flow velocity in the pipe 2–3 m/s.

Conversion formula for this series: $\dot{V}_2 = \dot{V}_1 \cdot \sqrt{\frac{p_2}{p_1}}$

Ordering Type + Material no. = Ordering no.
example: 612.366 + 5E.03 = 612.366.5E.03

Assembly accessories can be found in Chapter 9 "Accessories".

Low pressure flat fan nozzles for retaining nut

Series 656/657

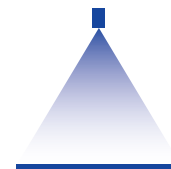

Features:

- Uniform, parabolic liquid distribution
- Stable spray angle
- High spray energy
- Assembly with retaining nut
- Non-clogging

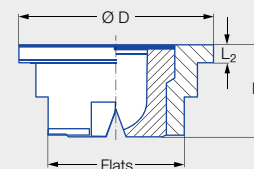

Applications:

- Cleaning installations
- Gravel washing
- Roll cooling
- Cooling of rolled stock
- Cooling pipes

Series 656/657

Code	Dimensions [mm]				Weight [g] Brass
	L ₁	L ₂	Ø D	Flats	
Assembly with retaining nut 3/4 BSPP	11.0	2.0	24.0	17	23.0

Spray angle	Ordering no.				Equivalent bore diameter A [mm]	Narrowest free cross section Ø [mm]	V̇ water [l/min]							Spray width B [mm] (at p = 5 bar)	
	Type	Mat. no.					p [bar]							H = 250 [mm]	H = 500 [mm]
		16	17 ¹	30			0.5	1.0	2.0	3.0	5.0	7.0	10.0		
20°	656.721	●	●	●	3.00	2.50	3.15	4.45	6.30	7.71	9.96	11.78	14.09	100	180
	656.801	●	●	●	4.00	3.20	5.00	7.07	10.00	12.25	15.81	18.71	22.36	100	180
	656.881	●	●	●	5.00	4.00	8.00	11.31	16.00	19.60	25.30	29.94	35.78	100	180
	656.921	●	●	●	5.50	4.40	10.00	14.14	20.00	24.49	31.62	37.41	44.72	100	180
	656.961	●	●	●	6.00	5.30	12.50	17.68	25.00	30.62	39.53	46.77	55.90	100	180
30°	656.722	●	●	●	3.00	2.40	3.15	4.45	6.30	7.71	9.96	11.78	14.09	140	260
	656.762	●	●	●	3.50	2.70	4.00	5.66	8.00	9.80	12.65	14.97	17.89	140	260
	656.802	●	●	●	4.00	3.10	5.00	7.07	10.00	12.25	15.81	18.71	22.36	140	260
	656.882	●	●	●	5.00	4.00	8.00	11.31	16.00	19.60	25.30	29.94	35.78	140	270
	656.922	●	●	●	5.50	4.40	10.00	14.14	20.00	24.49	31.62	37.41	44.72	140	270
656.962	●	●	●	6.00	5.00	12.50	17.68	25.00	30.62	39.53	46.77	55.90	140	270	
45°	656.723	●	●	●	3.00	2.40	3.15	4.45	6.30	7.71	9.96	11.78	14.09	220	420
	656.763	●	●	●	3.50	2.60	4.00	5.66	8.00	9.80	12.65	14.97	17.89	220	420
	656.803	●	●	●	4.00	3.00	5.00	7.07	10.00	12.25	15.81	18.71	22.36	220	420
	656.843	●	●	●	4.50	3.40	6.25	8.84	12.50	15.31	19.76	23.38	27.94	220	420
	656.883	●	●	●	5.00	3.80	8.00	11.31	16.00	19.60	25.30	29.94	35.78	220	420
	656.923	●	●	●	5.50	4.20	10.00	14.14	20.00	24.49	31.62	37.41	44.72	220	430
	656.963	●	●	●	6.00	4.40	12.50	17.68	25.00	30.62	39.53	46.77	55.90	220	430



Spray angle	Ordering no.				Equivalent bore diameter A [mm]	Narrowest free cross section Ø [mm]	V̇ water [l/min]							Spray width B [mm] (at p = 5 bar)	
	Type	Mat. no.					p [bar]							 H = 250 [mm] H = 500 [mm]	
		16	17 ¹	30			0.5	1.0	2.0	3.0	5.0	7.0	10.0		
		Stainless steel 303	Stainless steel 316Ti/ Stainless steel 316L	Brass											
60°	656.724	●	●	●	3.00	2.10	3.15	4.45	6.30	7.71	9.96	11.78	14.09	280	560
	656.764	●	●	●	3.50	2.30	4.00	5.66	8.00	9.80	12.65	14.97	17.89	280	570
	656.804	●	●	●	4.00	2.60	5.00	7.07	10.00	12.25	15.81	18.71	22.36	290	580
	656.844	●	●	●	4.50	3.00	6.25	8.84	12.50	15.31	19.76	23.38	27.94	290	580
	656.884	●	●	●	5.00	3.40	8.00	11.31	16.00	19.60	25.30	29.94	35.78	290	580
	656.924	●	●	●	5.50	4.10	10.00	14.14	20.00	24.49	31.62	37.41	44.72	290	580
	656.964	●	●	●	6.00	4.20	12.50	17.68	25.00	30.62	39.53	46.77	55.90	290	580
	657.044		●	●	8.00	5.50	20.00	28.29	40.00	48.99	63.25	74.84	89.45	290	580
90°	656.726	●	●	●	3.00	1.70	3.15	4.45	6.30	7.71	9.96	11.78	14.09	520	980
	656.766	●	●	●	3.50	1.90	4.00	5.66	8.00	9.80	12.65	14.97	17.89	530	1,000
	656.806	●	●	●	4.00	2.40	5.00	7.07	10.00	12.25	15.81	18.71	22.36	530	1,030
	656.846	●	●	●	4.50	2.40	6.25	8.84	12.50	15.31	19.76	23.38	27.94	540	1,050
	656.886	●	●	●	5.00	3.10	8.00	11.31	16.00	19.60	25.30	29.94	35.78	540	1,060
	656.926	●	●	●	5.50	3.60	10.00	14.14	20.00	24.49	31.62	37.41	44.72	540	1,070
	656.966	●	●	●	6.00	3.90	12.50	17.68	25.00	30.62	39.53	46.77	55.90	540	1,070
	657.046			●	8.00	4.90	20.00	28.29	40.00	48.99	63.25	74.84	89.45	540	1,070
120°	656.727	●	●	●	3.00	1.60	3.15	4.45	6.30	7.71	9.96	11.78	14.09	890	1,680
	656.767	●	●	●	3.50	1.70	4.00	5.66	8.00	9.80	12.65	14.97	17.89	900	1,700
	656.807	●	●	●	4.00	2.00	5.00	7.07	10.00	12.25	15.81	18.71	22.36	900	1,710
	656.887	●	●	●	5.00	2.60	8.00	11.31	16.00	19.60	25.30	29.94	35.78	910	1,710
	656.927	●	●	●	5.50	2.90	10.00	14.14	20.00	24.49	31.62	37.41	44.72	910	1,710

¹ We reserve the right to supply material 316Ti or 316L under material no. 17.

Conversion formula for this series: $\dot{V}_2 = \dot{V}_1 \cdot \sqrt{\frac{p_2}{p_1}}$

Ordering Type + Material no. = Ordering no.
 example: 656.724 + 16 = 656.724.16

 Assembly accessories can be found in Chapter 9 "Accessories".

Low pressure flat fan nozzles with dovetail guide

Series 660

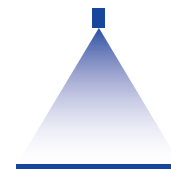

Features:

- Uniform, parabolic liquid distribution
- Stable spray angle
- Spray automatically aligned approx. 5° to the longitudinal axis of the pipe due to dovetail guide
- Assembly with retaining nut
- Non-clogging
- High spray energy

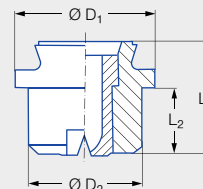

Series 660

Applications:

- Cleaning installations
- Spray pipes
- Cooling pipes

Code	Dimensions [mm]				Weight [g] Brass
	L ₁	L ₂	Ø D ₁	Ø D ₂	
Assembly with retaining nut 3/8 BSPP and dovetail guide	12.0	7.0	14.8	12.0	10.0

Spray angle	Ordering no.				Equivalent bore diameter A [mm]	Narrowest free cross section Ø [mm]	V̇ water [l/min]						Spray width B [mm] (at p = 5 bar)	
	Type	Mat. no.					p [bar]							
		16	17 ¹	30										
		Stainless steel 303	Stainless steel 316Ti/ Stainless steel 316L	Brass			0.5	1.0	2.0	3.0	5.0	10.0	H = 250 [mm]	H = 500 [mm]
20°	660.301	●	●	●	0.70	0.60	0.16*	0.23*	0.32	0.40	0.51	0.72	85	160
	660.361	●	●	●	1.00	0.80	0.32*	0.45*	0.63	0.77	1.00	1.41	85	160
	660.441	●	●	●	1.35	1.10	0.63*	0.89	1.25	1.53	1.98	2.80	85	160
	660.481	●	●	●	1.50	1.20	0.80*	1.13	1.60	1.96	2.53	3.58	85	160
30°	660.302	●	●	●	0.60	0.50	0.16*	0.23*	0.32	0.40	0.51	0.72	120	220
	660.362	●	●	●	1.00	0.70	0.32*	0.45*	0.63	0.77	1.00	1.41	120	220
	660.402	●	●	●	1.20	0.90	0.50*	0.71	1.00	1.22	1.58	2.23	120	230
	660.482	●	●	●	1.50	1.10	0.80*	1.13	1.60	1.96	2.53	3.58	130	230
	660.562	●	●	●	2.00	1.50	1.25	1.77	2.50	3.06	3.95	5.59	130	240
45°	660.303	●	●	●	0.70	0.50	0.16*	0.23*	0.32	0.40	0.51	0.72	170	330
	660.363	●	●	●	1.00	0.60	0.32*	0.45*	0.63	0.77	1.00	1.41	190	350
	660.403	●	●	●	1.20	0.90	0.50*	0.71	1.00	1.22	1.58	2.23	200	370
	660.483	●	●	●	1.50	1.10	0.80*	1.13	1.60	1.96	2.53	3.58	200	390
	660.563	●	●	●	2.00	1.40	1.25	1.77	2.50	3.06	3.95	5.59	210	410
	660.643	●	●	●	2.50	1.80	2.00	2.83	4.00	4.90	6.33	8.95	220	410
60°	660.304	●	●	●	0.70	0.40	0.16*	0.23*	0.32	0.40	0.51	0.72	260	480
	660.334	●	●	●	0.90	0.50	0.22*	0.32*	0.45	0.55	0.71	1.00	260	490
	660.364	●	●	●	1.00	0.60	0.32*	0.45*	0.63	0.77	1.00	1.41	260	500
	660.404	●	●	●	1.20	0.80	0.50*	0.71	1.00	1.22	1.58	2.23	260	510
	660.444	●	●	●	1.35	0.90	0.63*	0.89	1.25	1.53	1.98	2.80	260	510



Spray angle	Ordering no.				Equivalent bore diameter A [mm]	Narrowest free cross section Ø [mm]	V̇ water [l/min]						Spray width B [mm] (at p = 5 bar)	
	Type	Mat. no.					p [bar]						H = 250 [mm]	H = 500 [mm]
		16	17 ¹	30			0.5	1.0	2.0	3.0	5.0	10.0		
		Stainless steel 303	Stainless steel 316Ti/ Stainless steel 316L	Brass										
60°	660.484	●	●	●	1.50	1.00	0.80*	1.13	1.60	1.96	2.53	3.58	260	520
	660.514	●	●	●	1.65	1.10	0.95*	1.34	1.90	2.32	3.00	4.24	270	520
	660.564	●	●	●	2.00	1.30	1.25	1.77	2.50	3.06	3.95	5.59	270	530
	660.604	●	●	●	2.20	1.50	1.57	2.23	3.15	3.86	4.98	7.04	270	540
	660.644	●	●	●	2.50	1.60	2.00	2.83	4.00	4.90	6.33	8.95	270	540
	660.724	●	●	●	3.00	2.10	3.15	4.45	6.30	7.71	9.96	14.09	280	560
660.804	●		●	4.00	2.60	5.00	7.07	10.00	12.25	15.81	22.36	290	580	
75°	660.145	●		●	0.20	0.14	–	0.04*	0.05	0.06	0.08	0.11	380	690
	660.165	●		●	0.20	0.14	–	0.05*	0.07	0.08	0.10	0.15	380	690
	660.185	●		●	0.20	0.16	–	0.06*	0.08	0.10	0.13	0.18	380	690
	660.215	●		●	0.50	0.20	–	0.08*	0.11	0.14	0.18	0.25	380	690
	660.245	●		●	0.50	0.30	–	0.12*	0.16	0.20	0.26	0.37	380	690
	660.275	●		●	0.60	0.30	0.11*	0.16*	0.22	0.27	0.35	0.49	380	690
90°	660.216	●		●	0.40	0.20	–	0.08*	0.11	0.14	0.18	0.25	420	780
	660.276	●		●	0.60	0.30	0.11*	0.16*	0.22	0.27	0.35	0.49	430	790
	660.306	●	●	●	0.70	0.40	0.16*	0.23*	0.32	0.40	0.51	0.72	440	800
	660.336	●	●	●	0.90	0.50	0.22*	0.32*	0.45	0.55	0.71	1.00	440	820
	660.366	●	●	●	1.00	0.50	0.32*	0.45*	0.63	0.77	1.00	1.41	450	830
	660.406	●	●	●	1.20	0.70	0.50*	0.71	1.00	1.22	1.58	2.23	450	840
	660.446	●	●	●	1.35	0.80	0.63*	0.89	1.25	1.53	1.98	2.80	460	860
	660.486	●	●	●	1.50	0.80	0.80*	1.13	1.60	1.96	2.53	3.58	470	870
	660.516	●	●	●	1.65	0.90	0.95*	1.34	1.90	2.32	3.00	4.24	480	880
	660.566	●	●	●	2.00	1.10	1.25	1.77	2.50	3.06	3.95	5.59	490	900
	660.606	●	●	●	2.20	1.20	1.57	2.23	3.15	3.86	4.98	7.04	500	910
	660.646	●	●	●	2.50	1.30	2.00	2.83	4.00	4.90	6.33	8.95	510	930
	660.676	●	●	●	2.70	1.40	2.37	3.36	4.75	5.82	7.51	10.62	510	950
	660.726	●	●	●	3.00	1.70	3.15	4.45	6.30	7.71	9.96	14.09	520	980
660.806		●	●	4.00	2.40	5.00	7.07	10.00	12.25	15.81	22.36	530	1,030	
120°	660.187	●		●	0.35	0.20	–	0.06*	0.08	0.10	0.13	0.18	630	1,060
	660.217	●		●	0.40	0.20	–	0.08*	0.11	0.14	0.18	0.25	650	1,080
	660.247	●		●	0.50	0.30	–	0.12*	0.16	0.20	0.26	0.37	660	1,100
	660.277	●		●	0.60	0.30	–	0.16*	0.22	0.27	0.35	0.49	670	1,150
	660.307	●		●	0.70	0.30	0.16*	0.23*	0.32	0.40	0.51	0.72	710	1,240
	660.337	●	●	●	0.90	0.40	0.22*	0.32*	0.45	0.55	0.71	1.00	740	1,350
	660.367	●	●	●	1.00	0.40	0.32*	0.45*	0.63	0.77	1.00	1.41	800	1,430
	660.407	●	●	●	1.20	0.60	0.50*	0.71	1.00	1.22	1.58	2.23	830	1,480
	660.447	●	●	●	1.35	0.60	0.63*	0.88	1.25	1.53	1.98	2.80	840	1,520
	660.487	●	●	●	1.50	0.60	0.80*	1.13	1.60	1.96	2.53	3.58	850	1,540
	660.517	●	●	●	1.65	0.90	0.95*	1.34	1.90	2.32	3.00	4.24	850	1,560
	660.567	●	●	●	2.00	0.90	1.25	1.77	2.50	3.06	3.95	5.59	870	1,590
	660.607	●	●	●	2.20	1.10	1.57	2.23	3.15	3.86	4.98	7.04	870	1,620
	660.647	●	●	●	2.50	1.30	2.00	2.83	4.00	4.90	6.33	8.95	880	1,640
	660.727	●	●	●	3.00	1.60	3.15	4.45	6.30	7.71	9.96	14.09	890	1,680
	660.807	●		●	4.00	2.00	5.00	7.07	10.00	12.25	15.81	22.36	900	1,710

* Differing spray pattern.

¹ We reserve the right to supply material 316Ti or 316L under material no. 17.

Conversion formula for this series: $\dot{V}_2 = \dot{V}_1 \cdot \sqrt{\frac{P_2}{P_1}}$

Ordering Type + Material no. = Ordering no.
example: 660.484 + 16 = 660.484.16



Assembly accessories can be found in Chapter 9 "Accessories".

Low pressure flat fan nozzles with dovetail guide

Series 664/665



Features:

- Uniform, parabolic liquid distribution
- Stable spray angle
- Spray automatically aligned approx. 15° to the longitudinal axis of the pipe via dovetail guide
- Assembly with retaining nut
- Non-clogging
- High spray energy



Series 664/665

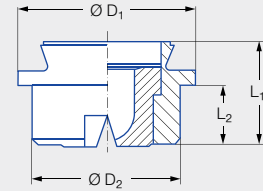

Applications:

- Cleaning installations
- Spray pipes
- Roll cooling
- Cooling pipes
- Cooling of rolled stock

Code	Dimensions [mm]				Weight [g]
	L ₁	L ₂	Ø D ₁	Ø D ₂	
Assembly with retaining nut 3/4 BSPP and dovetail guide	14.0	8.0	24.0	20.0	35.0

Spray angle	Ordering no.				Equivalent bore diameter A [mm]	Narrowest free cross section Ø [mm]	V̇ water [l/min]						Spray width B [mm] (at p = 5 bar)	
	Type	Mat. no.					p [bar]							
		16	17 ¹	30										
		Stainless steel 303	Stainless steel 316/TI	Stainless steel 316L			Brass	0.5	1.0	2.0	3.0	5.0	10.0	H = 250 [mm]
20°	664.721	●	●	●	3.00	2.50	3.15	4.45	6.30	7.71	9.96	14.09	100	180
	664.801	●	●	●	4.00	3.20	5.00	7.07	10.00	12.25	15.81	22.36	100	180
	664.881	●	●	●	5.00	4.00	8.00	11.31	16.00	19.60	25.30	35.78	100	180
	664.921	●	●	●	5.50	4.40	10.00	14.14	20.00	24.49	31.62	44.72	100	180
	664.961	●	●	●	6.00	5.10	12.50	17.68	25.00	30.62	39.53	55.90	100	180
30°	664.722	●	●	●	3.00	2.40	3.15	4.45	6.30	7.71	9.96	14.09	140	260
	664.762	●	●	●	3.50	2.70	4.00	5.66	8.00	9.80	12.65	17.89	140	260
	664.802	●	●	●	4.00	3.10	5.00	7.07	10.00	12.25	15.81	22.36	140	260
	664.882	●	●	●	5.00	4.00	8.00	11.31	16.00	19.60	25.30	35.78	140	270
	664.922	●	●	●	5.50	4.40	10.00	14.14	20.00	24.49	31.62	44.72	140	270
	664.962	●	●	●	6.00	5.00	12.50	17.68	25.00	30.62	39.53	55.90	140	270
	665.042	●		●	8.00	6.40	20.00	28.29	40.00	48.99	63.25	89.45	140	270
	665.122			●	10.00	8.20	31.50	44.55	63.00	77.16	99.61	140.87	140	270





Spray angle	Ordering no.				Equivalent bore diameter A [mm]	Narrowest free cross section Ø [mm]	V̇ water [l/min]						Spray width B [mm] (at p = 5 bar)	
	Type	Mat. no.					p [bar]						H = 250 [mm]	H = 500 [mm]
		16	17 ¹	30			0.5	1.0	2.0	3.0	5.0	10.0		
		Stainless steel 303	Stainless steel 316Ti/ Stainless steel 316L	Brass										
45°	664.723	●	●	●	3.00	2.40	3.15	4.45	6.30	7.71	9.96	14.09	220	420
	664.763	●	●	●	3.50	2.60	4.00	5.66	8.00	9.80	12.65	17.89	220	420
	664.803	●	●	●	4.00	3.00	5.00	7.07	10.00	12.25	15.81	22.36	220	420
	664.843	●	●	●	4.50	3.40	6.25	8.84	12.50	15.31	19.76	27.94	220	420
	664.883	●	●	●	5.00	3.80	8.00	11.31	16.00	19.60	25.30	35.78	220	420
	664.923	●	●	●	5.50	4.20	10.00	14.14	20.00	24.49	31.62	44.72	220	430
	664.963	●	●	●	6.00	4.40	12.50	17.68	25.00	30.62	39.53	55.90	220	430
	665.043			●	8.00	5.90	20.00	28.29	40.00	48.99	63.25	89.45	220	430
60°	664.724	●	●	●	3.00	2.10	3.15	4.45	6.30	7.71	9.96	14.09	280	560
	664.764	●	●	●	3.50	2.30	4.00	5.66	8.00	9.80	12.65	17.89	280	570
	664.804	●	●	●	4.00	2.60	5.00	7.07	10.00	12.25	15.81	22.36	290	580
	664.844	●	●	●	4.50	3.00	6.25	8.84	12.50	15.31	19.76	27.94	290	580
	664.884	●	●	●	5.00	3.40	8.00	11.31	16.00	19.60	25.30	35.78	290	580
	664.924	●	●	●	5.50	4.10	10.00	14.14	20.00	24.49	31.62	44.72	290	580
	664.964	●	●	●	6.00	4.20	12.50	17.68	25.00	30.62	39.53	55.90	290	580
	665.044	●	●	●	8.00	5.50	20.00	28.29	40.00	48.99	63.25	89.45	290	580
	665.084		●	●	9.00	6.20	25.00	35.36	50.00	61.24	79.06	111.81	290	580
	665.124			●	10.00	7.40	31.50	44.55	63.00	77.16	99.61	140.87	290	580
90°	664.726	●	●	●	3.00	1.70	3.15	4.45	6.30	7.71	9.96	14.09	520	980
	664.766	●	●	●	3.50	1.90	4.00	5.66	8.00	9.80	12.65	17.89	530	1,000
	664.806	●	●	●	4.00	2.40	5.00	7.07	10.00	12.25	15.81	22.36	530	1,030
	664.846	●	●	●	4.50	2.40	6.25	8.84	12.50	15.31	19.76	27.94	540	1,050
	664.886	●	●	●	5.00	3.10	8.00	11.31	16.00	19.60	25.30	35.78	540	1,060
	664.926	●	●	●	5.50	3.60	10.00	14.14	20.00	24.49	31.62	44.72	540	1,070
	664.966	●	●	●	6.00	3.90	12.50	17.68	25.00	30.62	39.53	55.90	540	1,070
	665.046			●	8.00	4.90	20.00	28.29	40.00	48.99	63.25	89.45	540	1,070
	665.126			●	10.00	6.40	31.50	44.55	63.00	77.16	99.61	140.87	540	1,070
120°	664.727	●	●	●	3.00	1.60	3.15	4.45	6.30	7.71	9.96	14.09	890	1,680
	664.767	●	●	●	3.50	1.70	4.00	5.66	8.00	9.80	12.65	17.89	900	1,700
	664.807	●	●	●	4.00	2.00	5.00	7.07	10.00	12.25	15.81	22.36	900	1,710
	664.887	●	●	●	5.00	2.60	8.00	11.31	16.00	19.60	25.30	35.78	910	1,710
	664.927	●	●	●	5.50	2.90	10.00	14.14	20.00	24.49	31.62	44.72	910	1,710
	664.967			●	6.00	3.20	12.50	17.68	25.00	30.62	39.53	55.90	910	1,710
	665.047			●	8.00	4.40	20.00	28.29	40.00	48.99	63.25	89.45	910	1,710

¹ We reserve the right to supply material 316Ti or 316L under material no. 17.

Conversion formula for this series: $\dot{V}_2 = \dot{V}_1 \cdot \sqrt{\frac{P_2}{P_1}}$

Ordering Type + Material no. = Ordering no.
example: 664.723 + 16 = 664.723.16



Assembly accessories can be found in Chapter 9 "Accessories".

Low pressure flat fan nozzles

Series 646

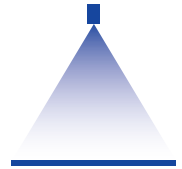

Features:

- Uniform, parabolic liquid distribution
- Adjusted spray direction
- Simple, fast manual assembly due to bayonet quick-release system

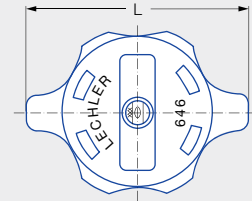

Applications:

- Belt cleaning
- Surface treatment
- Spray cleaning
- Coating processes

Series 646

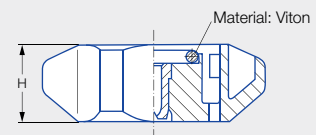

Dimensions [mm]		Weight [g]
H	L	
15.0	44.0	12.0

Spray angle	Ordering no.		Equivalent bore diameter A [mm]	Narrowest free cross section Ø [mm]	V̇ water [l/min]						Spray width B [mm] (at p = 5 bar)	
	Type	Mat. no.			p [bar]						 H = 250 [mm] H = 500 [mm]	
		5E			0.5	1.0	2.0	3.0	5.0	10.0		
		PVDF										
20°	646.301	●	0.70	0.60	0.16*	0.23*	0.32	0.39	0.51	0.72	85	160
	646.361	●	1.00	0.80	0.31*	0.44*	0.63	0.77	1.00	1.41	85	160
	646.441	●	1.35	1.10	0.63*	0.88	1.25	1.53	1.98	2.80	85	160
	646.481	●	1.50	1.20	0.80*	1.13	1.60	1.96	2.53	3.58	85	160
30°	646.302	●	0.70	0.50	0.16*	0.23*	0.32	0.39	0.51	0.72	120	220
	646.362	●	1.00	0.70	0.31*	0.44*	0.63	0.77	1.00	1.40	120	220
	646.402	●	1.20	0.90	0.50*	0.71	1.00	1.22	1.58	2.24	120	230
	646.482	●	1.50	1.10	0.80*	1.13	1.60	1.96	2.53	3.58	130	230
	646.562	●	2.00	1.50	1.25	1.77	2.50	3.06	3.95	5.59	130	240
45°	646.363	●	1.00	0.60	0.31*	0.44*	0.63	0.77	1.00	1.40	190	350
	646.403	●	1.20	0.90	0.50*	0.71	1.00	1.23	1.58	2.24	200	370
	646.483	●	1.50	1.10	0.80*	1.13	1.60	1.96	2.53	3.58	200	390
	646.563	●	2.00	1.40	1.20	1.77	2.50	3.06	3.95	5.59	210	410
	646.643	●	2.50	1.80	2.00	2.83	4.00	4.90	6.32	8.94	210	410
60°	646.304	●	0.70	0.40	0.16*	0.23*	0.32	0.39	0.51	0.72	260	480
	646.334	●	0.90	0.50	0.23*	0.32*	0.45	0.55	0.71	1.01	260	490
	646.364	●	1.00	0.60	0.32*	0.45*	0.63	0.77	1.00	1.41	260	500
	646.404	●	1.20	0.80	0.50*	0.71	1.00	1.22	1.58	2.24	260	510
	646.444	●	1.35	0.90	0.63*	0.88	1.25	1.53	1.98	2.80	260	510
	646.484	●	1.50	1.00	0.80*	1.13	1.60	1.96	2.53	3.58	260	520
	646.514	●	1.65	1.10	0.95*	1.34	1.90	2.33	3.00	4.25	270	520
	646.564	●	2.00	1.30	1.25	1.77	2.50	3.06	3.95	5.59	270	530
646.604	●	2.20	1.50	1.58	2.23	3.15	3.86	4.98	7.04	270	540	



Spray angle	Ordering no.		Equivalent bore diameter A [mm]	Narrowest free cross section Ø [mm]	V̇ water [l/min]						Spray width B [mm] (at p = 5 bar)	
	Type	Mat. no.			p [bar]						H = 250 [mm]	H = 500 [mm]
		5E			0.5	1.0	2.0	3.0	5.0	10.0		
90°		PVDF										
	646.306	●	0.70	0.40	0.16*	0.23*	0.32	0.39	0.51	0.72	440	800
	646.336	●	0.90	0.50	0.23*	0.32*	0.45	0.55	0.71	1.01	440	820
	646.366	●	1.00	0.50	0.32*	0.45*	0.63	0.77	1.00	1.41	450	830
	646.406	●	1.20	0.70	0.50*	0.71	1.00	1.22	1.58	2.24	450	840
	646.446	●	1.35	0.80	0.63*	0.88	1.25	1.53	1.98	2.80	460	860
	646.486	●	1.50	0.80	0.80*	1.13	1.60	1.96	2.53	3.58	470	870
	646.516	●	1.65	0.90	0.95*	1.34	1.90	2.33	3.00	4.25	480	880
646.566	●	2.00	1.10	1.25	1.77	2.50	3.06	3.95	5.59	490	900	
646.606	●	2.20	1.20	1.58	2.23	3.15	3.86	4.98	7.04	500	910	
120°	646.307	●	0.70	0.30	0.16*	0.23*	0.32	0.39	0.51	0.72	710	1,240
	646.337	●	0.90	0.40	0.23*	0.32*	0.45	0.55	0.71	1.01	740	1,310
	646.367	●	1.00	0.50	0.32*	0.45*	0.63	0.77	1.00	1.41	800	1,350
	646.407	●	1.20	0.60	0.50*	0.71	1.00	1.22	1.58	2.24	830	1,390
	646.447	●	1.35	0.60	0.63*	0.88	1.25	1.53	1.98	2.80	840	1,410
	646.487	●	1.50	0.60	0.80*	1.13	1.60	1.96	2.53	3.58	850	1,420
	646.517	●	1.65	0.90	0.95*	1.34	1.90	2.33	3.00	4.25	850	1,430
	646.567	●	2.00	0.90	1.25	1.77	2.50	3.06	3.95	5.59	870	1,440
646.607	●	2.20	1.10	1.58	2.23	3.15	3.86	4.98	7.04	870	1,450	

* Differing spray pattern.



Conversion formula for this series: $\dot{V}_2 = \dot{V}_1 \cdot \sqrt{\frac{p_2}{p_1}}$

Ordering Type + Material no. = Ordering no.
example: 646.306 + 5E = 646.306*

 Assembly accessories can be found in Chapter 9 "Accessories".

Low pressure tongue-type nozzles

Series 688/689

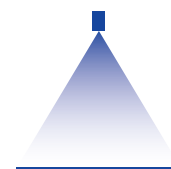

Features:

- Narrowly delimited, powerful flat fan spray
- Non-clogging

Applications:

- Cleaning processes
- Washing processes
- Degreasing installations
- Phosphating installations
- Preparation techniques

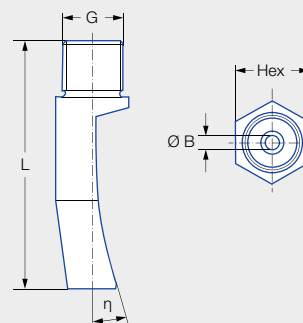

Series 688/689

Type	Code	G	Dimensions [mm]		Weight [g]
			L	Hex	
688.763	CE	3/8 BSPT	43.0	19	114.0 (Stainless steel 303)
688.843	CE	3/8 BSPT	50.0	19	133.0 (Stainless steel 303)
688.923	CE	3/8 BSPT	59.0	22	247.0 (Stainless steel 303)
689.003	90	3/4 BSPP	80.0	32/24	306.0/33.0 (Stainless steel 303/PVDF)

Spray angle	η	Ordering no.				Bore diameter B [mm]	V̇ water [l/min]				Spray width B [mm] (at p = 2 bar)				
		Mat. no.		Code			p [bar]								
		16	5E								H = 250 [mm]	H = 500 [mm]			
		Stainless steel 303	PVDF	3/8 BSPT	3/4 BSPP		0.5	1.0	2.0	5.0					
45°	35°	688.763	●		CE				3.00	4.00	5.66	8.00	12.65	220	420
	30°	688.843	●		CE				3.80	6.25	8.84	12.50	19.76	220	420
	29°	688.923	●		CE				4.80	10.00	14.14	20.00	31.62	220	430
	35°	689.003	●	●		90			6.00	15.75	22.27	31.50	49.81	220	430

Conversion formula for this series: $\dot{V}_2 = \dot{V}_1 \cdot \sqrt{\frac{p_2}{p_1}}$

Ordering Type + Material no. + Code = Ordering no.
 example: 688.763 + 16 + CE = 688.763.16.CE

Assembly accessories can be found in Chapter 9 "Accessories".

Low pressure tongue-type nozzles

Series 686

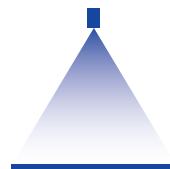

Features:

- Sharply delimited, powerful flat fan spray
- Large spray angle
- Non-clogging

Applications:

- Foam control
- Cleaning processes
- Washing processes



Series 686

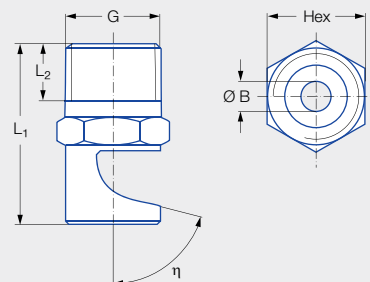

Type	BSP BSPT	Code	Dimensions [mm]			Weight [g] Brass
			L ₁	L ₂	Hex	
686.366	1/8	CA	23.0	6.5	11	13.0
686.406	1/8	CA	23.0	6.5	11	13.0
686.686	1/4	CC	29.5	9.7	14	23.0
686.726	1/8	CA	25.0	6.5	11	13.0
686.806	1/4	CC	33.0	9.7	14	24.0
686.886	1/4	CC	35.0	9.7	17	30.0
686.926	3/8	CE	38.5	10.1	17	32.0
686.368	1/8	CA	20.0	6.5	11	13.0
686.408	1/8	CA	23.0	6.5	11	13.0
686.448	1/4	CC	24.0	9.7	14	21.0
686.488	1/8	CA	23.0	6.5	11	13.0
686.488	1/4	CC	24.0	9.7	14	21.0
686.528	1/8	CA	23.0	6.5	11	13.0
686.528	1/4	CC	24.0	9.7	14	21.0
686.568	1/8	CA	23.0	6.5	11	13.0
686.568	1/4	CC	24.0	9.7	14	21.0
686.608	1/8	CA	23.0	6.5	11	13.0
686.608	1/4	CC	24.0	9.7	14	21.0
686.648	1/4	CC	24.0	9.7	14	21.0
686.688	1/8	CA	23.0	6.5	11	13.0
686.688	1/4	CC	27.0	9.7	14	22.0
686.728	1/8	CA	23.0	6.5	11	13.0
686.728	1/4	CC	27.0	9.7	14	22.0
686.768	1/4	CC	27.0	9.7	14	22.0
686.808	1/8	CA	23.0	6.5	11	13.0
686.808	1/4	CC	27.0	9.7	14	22.0
686.828	1/4	CC	27.0	9.7	14	22.0
686.848	1/4	CC	27.0	9.7	14	22.0
686.868	1/4	CC	28.0	9.7	14	23.0
686.888	1/4	CC	28.0	9.7	14	23.0
686.908	1/4	CC	28.0	9.7	14	23.0
686.928	3/8	CE	30.0	10.1	17	32.0
686.968	1/2	CG	37.0	13.2	22	60.0
686.988	3/8	CE	32.0	10.1	17	32.0
686.988	1/2	CG	37.0	13.2	22	60.0

Also suitable for air or saturated steam
(see Page 172).

Spray angle	η	Ordering no.								Bore diameter B [mm]	V water [l/min]			Spray width B [mm] (at p = 2 bar)
		Mat. no.			Code				p [bar]					
		16	30	5E							1.0	2.0	5.0	H = 250 [mm]
		Stainless steel 303	Brass	PVDF	1/8 BSPT	1/4 BSPT	3/8 BSPT	1/2 BSPT						
90°	75°	686.366		●		CA				0.80	0.45	0.63	1.00	450
		686.406	●	●		CA				1.00	0.71	1.00	1.58	450
	40°	686.686	●	●			CC			2.40	3.54	5.00	7.91	510
		686.726		●		CA				2.70	4.45	6.30	9.96	530
		686.806	●	●			CC			3.40	7.07	10.00	15.81	540
		686.886	●				CC			4.20	11.31	16.00	25.30	540
686.926	●					CE		4.70	14.14	20.00	31.62	540		
140°	75°	686.368	●	●		CA				0.80	0.45	0.63	1.00	1,250
		686.408	●	●		CA				1.00	0.71	1.00	1.58	1,260
		686.448	●	●			CC			1.20	0.88	1.25	1.98	1,260
		686.488	●	●		CA	CC			1.30	1.13	1.60	2.53	1,270
		686.528	●	●		CA	CC			1.50	1.41	2.00	3.16	1,280
		686.568	●	●	● ¹	CA	CC			1.70	1.77	2.50	3.95	1,290
		686.608	●	●		CA	CC			1.90	2.23	3.15	4.98	1,300
		686.648	●	●			CC			2.20	2.83	4.00	6.32	1,320
		686.688	●	●		CA	CC			2.40	3.54	5.00	7.91	1,330
		686.728	●	●		CA	CC			2.70	4.45	6.30	9.96	1,340
		686.768	●	●			CC			3.00	5.66	8.00	12.65	1,350
		686.808	●	●		CA	CC			3.40	7.07	10.00	15.81	1,360
		686.828	●	●			CC			3.60	7.92	11.20	17.71	1,360
		686.848	●	●			CC			3.80	8.84	12.50	19.76	1,360
		686.868	●	●			CC			4.00	9.90	14.00	22.14	1,360
		686.888	●	●			CC			4.20	11.31	16.00	25.30	1,360
		686.908	●	●			CC			4.50	12.73	18.00	28.46	1,360
		686.928	●					CE		4.70	14.14	20.00	31.62	1,360
686.968		●					CG	5.30	17.68	25.00	39.53	1,360		
686.988	●					CE	CG	5.60	19.80	28.00	44.27	1,360		

¹ Only available with code CA.

Conversion formula for this series: $\dot{V}_2 = \dot{V}_1 \cdot \sqrt{\frac{p_2}{p_1}}$

Ordering Type + Material no. + Code = Ordering no.
example: 686.366 + 30 + CA = 686.366.30.CA



Assembly accessories can be found in Chapter 9 "Accessories".

Low pressure tongue-type nozzles Series 684

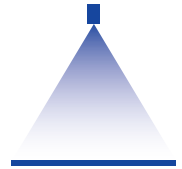

Features:

- Sharply delimited, powerful flat fan spray
- Large spray angle
- Assembly with retaining nut
- Non-clogging

Applications:

- Foam control
- Cleaning processes
- Washing processes



Series 684

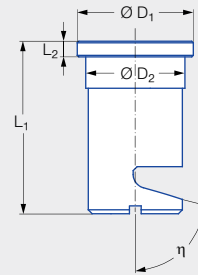

G	Dimensions [mm]			Weight [g]
	L ₂	Ø D ₁	Ø D ₂	
Assembly with retaining nut 3/8 BSPP	2.00	14.80	12.65	3.00

Spray angle	η	Ordering no.		Color ¹	Bore diameter B [mm]	L ₁ [mm]	V̇ water [l/min]			Spray width B [mm] (at p = 2 bar)	
		Type	Mat. no.				p [bar]				
			56				5E	1.0	2.0	5.0	H = 250 [mm]
140°	75°	684.348	●		Green	0.70	20.00	0.35*	0.50	0.79	1,240
		684.368	●	●	Yellow	0.80	20.00	0.45*	0.63	1.00	1,250
		684.408	●		Blue	1.00	20.00	0.71	1.00	1.58	1,260
		684.448	●		Red	1.20	20.00	0.88	1.25	1.98	1,260
		684.488	●	●	Brown	1.30	20.00	1.13	1.60	2.53	1,270
		684.528	●		Grey	1.50	20.00	1.41	2.00	3.16	1,280
		684.568	●	●	White	1.70	19.00	1.77	2.50	3.95	1,290
		684.608	●		Light blue	1.90	19.00	2.23	3.15	4.98	1,300
		684.688	●		Green	2.40	17.00	3.54	5.00	7.91	1,330
		684.728	●	●	Black	2.70	17.00	4.45	6.30	9.96	1,340
684.808	●		Beige	3.40	16.00	7.07	10.00	15.81	1,340		

* Differing spray pattern.

¹ PVDF material is always blue.

Assembly example

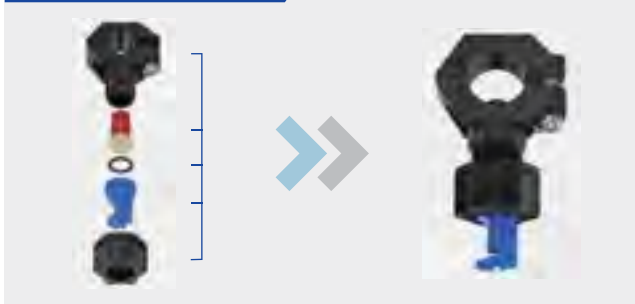

Conversion formula for this series: $\dot{V}_2 = \dot{V}_1 \cdot \sqrt{\frac{p_2}{p_1}}$

Ordering Type + Material no. = Ordering no.
example: 684.348 + 56 = 684.348.56

Assembly accessories can be found in Chapter 9 "Accessories".

High pressure flat fan nozzles

Series 602

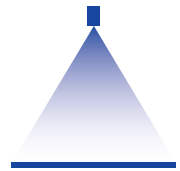

Features:

- Sharp, uniform flat fan spray
- Extremely narrow spray depth
- Housing: Stainless steel 303,
Insert: Hardened stainless steel 420F

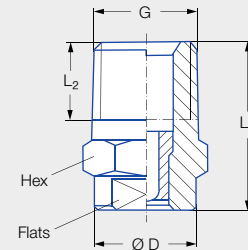

Applications:

- High pressure cleaning

Series 602

G	Dimensions [mm]					Weight [g]	p _{max} ¹ [bar]
	L ₁	L ₂	Ø D	Hex	Flats		
1/4 BSPT	22.0	10.0	13.0	14	10	18.0	approx. 700
1/4 NPT	22.0	10.2	13.0	14	10	18.0	approx. 700

¹ Applies only to operation at constant pressure.

US gal/min at 40 psi	Ordering no.								Equivalent bore diameter A [mm]	V̇ water [l/min]						
	Series	Flow rate code				Mat. no. A3 Stainless steel 303/420F	Code			p [bar]						
		Spray angle					1/4 BSPT	1/4 NPT								
		20°	30°	45°	60°					40	60	80	100	120	150	200
02	602	361	362	363	364	●	00	07	1.00	2.88	3.53	4.08	4.56	5.00	5.58	6.45
021	602	371	372	373	374	●	00	07	1.02	3.03	3.71	4.28	4.79	5.25	5.87	6.77
025	602	381	382	383	384	●	00	07	1.10	3.60	4.42	5.10	5.70	6.24	6.98	8.06
028	602	391	392	393	394	●	00	07	1.16	4.04	4.94	5.71	6.38	6.99	7.81	9.02
03	602	401	402	403	404	●	00	07	1.18	4.32	5.29	6.11	6.83	7.48	8.37	9.66
034	602	411	412	413	414	●	00	07	1.30	4.90	6.00	6.93	7.75	8.49	9.49	10.96
038	602	441	442	443		●	00	07	1.33	5.48	6.72	7.75	8.67	9.50	10.62	12.26
04	602	451	452	453	454	●	00	07	1.35	5.77	7.06	8.16	9.12	9.99	11.17	12.90
043	602	461	462			●	00	07	1.38	6.20	7.59	8.77	9.80	10.74	12.00	13.86
045	602	471	472	473	474	●	00	07	1.40	6.49	7.95	9.18	10.26	11.24	12.57	14.51
05	602	481	482	483	484	●	00	07	1.55	7.21	8.83	10.20	11.40	12.49	13.96	16.12
055	602	501	502	503	504	●	00	07	1.60	7.93	9.71	11.22	12.54	13.74	15.36	17.73
06	602	521	522	523	524	●	00	07	1.72	8.65	10.60	12.24	13.68	14.99	16.75	19.35
065	602	531	532	533	534	●	00	07	1.75	9.37	11.48	13.26	14.82	16.23	18.15	20.96
07	602	541	542	543	544	●	00	07	1.80	10.09	12.36	14.28	15.96	17.48	19.55	22.57
075	602	551	552	553	554	●	00	07	1.90	10.81	13.25	15.29	17.10	18.73	20.94	24.18
08	602	571	572	573	574	●	00	07	2.05	11.54	14.13	16.31	18.24	19.98	22.34	25.80
087	602	581	582	583	584	●	00	07	2.06	12.54	15.36	17.74	19.83	21.72	24.29	28.04
09	602	591	592	593	594	●	00	07	2.10	12.98	15.89	18.35	20.52	22.48	25.13	29.02
10	602	601	602	603	604	●	00	07	2.30	14.41	17.65	20.38	22.79	24.97	27.91	32.23
11	602	621	622	623	624	●	00	07	2.40	15.86	19.42	22.42	25.07	27.46	30.70	35.45
125	602	641	642	643	644	●	00	07	2.50	18.02	22.07	25.48	28.49	31.21	34.89	40.29
131	602	651	652	653	654	●	00	07	2.55	18.89	23.13	26.71	29.86	32.71	36.57	42.23
139	602	661	662	663	664	●	00	07	2.65	20.04	24.54	28.34	31.68	34.70	38.80	44.80
15	602	671	672	673	674	●	00	07	2.70	21.62	26.48	30.58	34.19	37.45	41.87	48.35
175	602	701	702	703	704	●	00	07	3.00	25.23	30.90	35.68	39.89	43.70	48.86	56.41
20	602			723	724	●	00	07	3.05	28.83	35.31	40.78	45.59	49.94	55.84	64.47
25	602			763	764	●	00	07	3.50	36.04	44.14	50.97	56.99	62.43	69.80	80.60
30	602			793		●	00	07	3.90	43.25	52.97	61.16	68.38	74.91	83.75	96.70

Conversion formula for this series: $\dot{V}_2 = \dot{V}_1 \cdot \sqrt{\frac{P_2}{P_1}}$

Assembly accessories can be found in Chapter 9 "Accessories".

Ordering Series + Flow rate code + Material no. + Code = Ordering no.
example: 602 + 361 + A3 + 00 = 602.361.A3.00

High pressure flat fan nozzles

Series 608

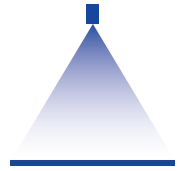

Features:

- Sharp, uniform flat fan spray
- Extremely narrow spray depth
- Housing: Stainless steel 303,
Insert: Hardened stainless steel 420F

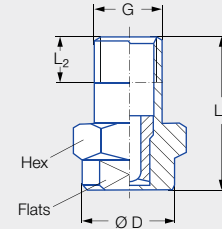

Applications:

- High pressure cleaning

Series 608

G	Dimensions [mm]					Weight [g]	p _{max} ¹ [bar]
	L ₁	L ₂	Ø D	Hex	Flats		
1/8 BSPT	22.0	6.5	13.0	14	10	13.0	approx. 700
1/8 NPT	22.0	6.7	13.0	14	10	13.0	approx. 700

¹ Applies only to operation at constant pressure.

US gal/min at 40 psi	Ordering no.								Equivalent bore diameter A [mm]	V̇ water [l/min]						
	Series	Flow rate code				Mat. no. A3 Stainless steel 303/420F	Code			p [bar]						
		Spray angle					1/8 BSPT	1/8 NPT		40	60	80	100	120	150	200
		20°	30°	45°	60°											
02	608	361	362	363	364	●	00	07	1.00	2.88	3.53	4.08	4.56	5.00	5.58	6.45
021	608	371	372	373	374	●	00	07	1.02	3.03	3.71	4.28	4.79	5.25	5.87	6.77
025	608	381	382	383	384	●	00	07	1.10	3.60	4.42	5.10	5.70	6.24	6.98	8.06
028	608	391	392	393	394	●	00	07	1.16	4.04	4.94	5.71	6.38	6.99	7.81	9.02
03	608	401	402	403	404	●	00	07	1.18	4.32	5.29	6.11	6.83	7.48	8.37	9.66
034	608	411	412	413	414	●	00	07	1.30	4.90	6.00	6.93	7.75	8.49	9.49	10.96
038	608	441	442	443		●	00	07	1.33	5.48	6.72	7.75	8.67	9.50	10.62	12.26
04	608	451	452	453	454	●	00	07	1.35	5.77	7.06	8.16	9.12	9.99	11.17	12.90
043	608	461	462			●	00	07	1.38	6.20	7.59	8.77	9.80	10.74	12.00	13.86
045	608	471	472	473	474	●	00	07	1.40	6.49	7.95	9.18	10.26	11.24	12.57	14.51
05	608	481	482	483	484	●	00	07	1.55	7.21	8.83	10.20	11.40	12.49	13.96	16.12
055	608	501	502	503	504	●	00	07	1.60	7.93	9.71	11.22	12.54	13.74	15.36	17.73
06	608	521	522	523	524	●	00	07	1.72	8.65	10.60	12.24	13.68	14.99	16.75	19.35
065	608	531	532	533	534	●	00	07	1.75	9.37	11.48	13.26	14.82	16.23	18.15	20.96
07	608	541	542	543	544	●	00	07	1.80	10.09	12.36	14.28	15.96	17.48	19.55	22.57
075	608	551	552	553	554	●	00	07	1.90	10.81	13.25	15.29	17.10	18.73	20.94	24.18
08	608	571	572	573	574	●	00	07	2.05	11.54	14.13	16.31	18.24	19.98	22.34	25.80
087	608	581	582	583	584	●	00	07	2.06	12.54	15.36	17.74	19.83	21.72	24.29	28.04
09	608	591	592	593	594	●	00	07	2.10	12.98	15.89	18.35	20.52	22.48	25.13	29.02
10	608	601	602	603	604	●	00	07	2.30	14.41	17.65	20.38	22.79	24.97	27.91	32.23

Conversion formula for this series: $\dot{V}_2 = \dot{V}_1 \cdot \sqrt{\frac{P_2}{P_1}}$



Assembly accessories can be found in Chapter 9 "Accessories".

Ordering Series + Flow rate code + Material no. + Code = Ordering no.
example: 608 + 361 + A3 + 00 = 608.361.A3.00

High pressure flat fan nozzles

Series 652

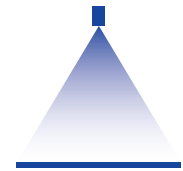

Features:

- Sharp, uniform flat fan spray
- Extremely narrow spray depth
- Assembly with retaining nut
- Housing: Stainless steel 303, Insert: Hardened stainless steel 420F

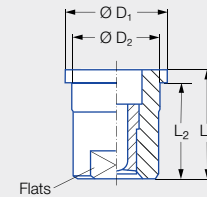

Applications:

- High pressure cleaning

Series 652

G	Dimensions [mm]					Weight [g]	p _{max} ¹ [bar]
	L ₁	L ₂	Ø D ₁	Ø D ₂	Flats		
Assembly with retaining nut 3/8 BSPP	16.00	14.00	14.80	12.65	10	13.00	approx. 300

¹ Applies only to operation at constant pressure.

US gal/min at 40 psi	Ordering no.							Equivalent bore diameter A [mm]	V̇ water [l/min]						
	Series	Flow rate code				Mat. no. Stainless steel 303/420F	Code For retaining nut		p [bar]						
		Spray angle													
		20°	30°	45°	60°				40	60	80	100	120	150	200
02	652	361	362	363	364	●	29	1.00	2.88	3.53	4.08	4.56	5.00	5.58	6.45
021	652	371	372	373	374	●	29	1.02	3.03	3.71	4.28	4.79	5.25	5.87	6.77
025	652	381	382	383	384	●	29	1.10	3.60	4.42	5.10	5.70	6.24	6.98	8.06
028	652	391	392	393	394	●	29	1.16	4.04	4.94	5.71	6.38	6.99	7.81	9.02
03	652	401	402	403	404	●	29	1.18	4.32	5.29	6.11	6.83	7.48	8.37	9.66
034	652	411	412	413	414	●	29	1.30	4.90	6.00	6.93	7.75	8.49	9.49	10.96
038	652	441	442	443		●	29	1.33	5.48	6.72	7.75	8.67	9.50	10.62	12.26
04	652	451	452	453	454	●	29	1.35	5.77	7.06	8.16	9.12	9.99	11.17	12.90
043	652	461	462			●	29	1.38	6.20	7.59	8.77	9.80	10.74	12.00	13.86
045	652	471	472	473	474	●	29	1.40	6.49	7.95	9.18	10.26	11.24	12.57	14.51
05	652	481	482	483	484	●	29	1.55	7.21	8.83	10.20	11.40	12.49	13.96	16.12
055	652	501	502	503	504	●	29	1.60	7.93	9.71	11.22	12.54	13.74	15.36	17.73
06	652	521	522	523	524	●	29	1.72	8.65	10.60	12.24	13.68	14.99	16.75	19.35
065	652	531	532	533	534	●	29	1.75	9.37	11.48	13.26	14.82	16.23	18.15	20.96
07	652	541	542	543	544	●	29	1.80	10.09	12.36	14.28	15.96	17.48	19.55	22.57
075	652	551	552	553	554	●	29	1.90	10.81	13.25	15.29	17.10	18.73	20.94	24.18
08	652	571	572	573	574	●	29	2.05	11.54	14.13	16.31	18.24	19.98	22.34	25.80
087	652	581	582	583	584	●	29	2.06	12.54	15.36	17.74	19.83	21.72	24.29	28.04
09	652	591	592	593	594	●	29	2.10	12.98	15.89	18.35	20.52	22.48	25.13	29.02
10	652	601	602	603	604	●	29	2.30	14.41	17.65	20.38	22.79	24.97	27.91	32.23
11	652	621	622	623	624	●	29	2.40	15.86	19.42	22.42	25.07	27.46	30.70	35.45
125	652	641	642	643	644	●	29	2.50	18.02	22.07	25.48	28.49	31.21	34.89	40.29
131	652	651	652	653	654	●	29	2.55	18.89	23.13	26.71	29.86	32.71	36.57	42.23
139	652	661	662	663	664	●	29	2.65	20.04	24.54	28.34	31.68	34.70	38.80	44.80
15	652	671	672	673	674	●	29	2.70	21.62	26.48	30.58	34.19	37.45	41.87	48.35
175	652	701	702	703	704	●	29	3.00	25.23	30.90	35.68	39.89	43.70	48.86	56.41
20	652			723	724	●	29	3.05	28.83	35.31	40.78	45.59	49.94	55.84	64.47
25	652			763	764	●	29	3.50	36.04	44.14	50.97	56.99	62.43	69.80	80.60
30	652			793		●	29	3.90	43.25	52.97	61.16	68.38	74.91	83.75	96.70

Conversion formula for this series: $\dot{V}_2 = \dot{V}_1 \cdot \sqrt{\frac{P_2}{P_1}}$

Assembly accessories can be found in Chapter 9 "Accessories".

Ordering Series + Flow rate code + Material no. + Code = Ordering no.
example: 652 + 361 + A3 + 29 = 652.361.A3.29

High pressure flat fan nozzles

Series 6FH with spray stabiliser

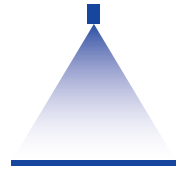

Features:

- Sharp, uniform flat fan spray
- Extremely narrow spray depth
- Nozzle with spray stabilizer
- Housing: Stainless steel 303,
Insert: Hardened stainless steel 420F,
spray stabiliser: Stainless steel 301

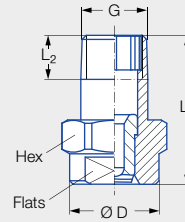

Figure 1

Applications:

- High pressure cleaning

Series 6FH

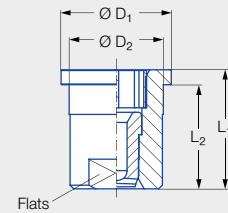

Figure 2

Code	Figure	G	Dimensions [mm]							Weight [g]	p _{max} ¹ [bar]
			L ₁	L ₂	Ø D	Ø D ₁	Ø D ₂	Hex	Flats		
CA	1	1/8 BSPT	22.00	6.50	13.00	–	–	14	10	13.00	approx. 700
BA	1	1/8 NPT	22.00	6.70	13.00	–	–	14	10	13.00	approx. 700
CC	1	1/4 BSPT	22.00	10.00	13.00	–	–	14	10	18.00	approx. 700
BC	1	1/4 NPT	22.00	10.20	13.00	–	–	14	10	18.00	approx. 700
Assembly with retaining nut 3/8 BSPP	2	–	16.00	14.00	–	14.80	12.65	–	10	13.00	approx. 300

¹ Applies only to operation at constant pressure.

US gal/min at 40 psi	Series	Ordering no.					Equivalent bore diameter A [mm]	V̇ water [l/min]							
		Flow rate code				Mat. no. Stainless steel 303/420F/301		p [bar]							
		Spray angle						A3	40	60	80	100	120	150	200
		20°	30°	45°	60°										
02	6FH	361	362	363	364	●	1.00	2.88	3.53	4.08	4.56	5.00	5.58	6.45	
021	6FH	371	372	373	374	●	1.02	3.03	3.71	4.28	4.79	5.25	5.87	6.77	
025	6FH	381	382	383	384	●	1.10	3.60	4.42	5.10	5.70	6.24	6.98	8.06	
028	6FH	391	392	393	394	●	1.16	4.04	4.94	5.71	6.38	6.99	7.81	9.02	
03	6FH	401	402	403	404	●	1.18	4.32	5.29	6.11	6.83	7.48	8.37	9.66	
034	6FH	411	412	413	414	●	1.30	4.90	6.00	6.93	7.75	8.49	9.49	10.96	
038	6FH	441	442	443		●	1.33	5.48	6.72	7.75	8.67	9.50	10.62	12.26	
04	6FH	451	452	453	454	●	1.35	5.77	7.06	8.16	9.12	9.99	11.17	12.90	
043	6FH	461	462			●	1.38	6.20	7.59	8.77	9.80	10.74	12.00	13.86	
045	6FH	471	472	473	474	●	1.40	6.49	7.95	9.18	10.26	11.24	12.57	14.51	
05	6FH	481	482	483	484	●	1.55	7.21	8.83	10.20	11.40	12.49	13.96	16.12	
055	6FH	501	502	503	504	●	1.60	7.93	9.71	11.22	12.54	13.74	15.36	17.73	
06	6FH	521	522	523	524	●	1.72	8.65	10.60	12.24	13.68	14.99	16.75	19.35	
065	6FH	531	532	533	534	●	1.75	9.37	11.48	13.26	14.82	16.23	18.15	20.96	

US gal/min at 40 psi	Ordering no.						Equivalent bore diameter A [mm]	V̇ water [l/min]						
	Series	Flow rate code				Mat. no. A3 Stainless steel 303/420F/301		p [bar]						
		Spray angle						40	60	80	100	120	150	200
		20°	30°	45°	60°									
07	6FH	541	542	543	544	●	1.80	10.09	12.36	14.28	15.96	17.48	19.55	22.57
075	6FH	551	552	553	554	●	1.90	10.81	13.25	15.29	17.10	18.73	20.94	24.18
008	6FH	571	572	573	574	●	2.05	11.54	14.13	16.31	18.24	19.98	22.34	25.80
087	6FH	581	582	583	584	●	2.06	12.54	15.36	17.74	19.83	21.72	24.29	28.04
09	6FH	591	592	593	594	●	2.10	12.98	15.89	18.35	20.52	22.48	25.13	29.02
10	6FH	601	602	603	604	●	2.30	14.41	17.65	20.38	22.79	24.97	27.91	32.23
11	6FH	621*	622*	623*	624*	●	2.40	15.86	19.42	22.42	25.07	27.46	30.70	35.45
125	6FH	641*	642*	643*	644*	●	2.50	18.02	22.07	25.48	28.49	31.21	34.89	40.29
131	6FH	651*	652*	653*	654*	●	2.55	18.89	23.13	26.71	29.86	32.71	36.57	42.23
139	6FH	661*	662*	663*	664*	●	2.65	20.04	24.54	28.34	31.68	34.70	38.80	44.80
15	6FH	671*	672*	673*	674*	●	2.70	21.62	26.48	30.58	34.19	37.45	41.87	48.35
175	6FH	701*	702*	703*	704*	●	3.00	25.23	30.9	35.68	39.89	43.70	48.86	56.41
20	6FH			723*	724*	●	3.05	28.83	35.31	40.78	45.59	49.94	55.84	64.47
25	6FH			763*	764*	●	3.50	36.04	44.14	50.97	56.99	62.43	69.80	80.60
30	6FH			793*		●	3.90	43.25	52.97	61.16	68.38	74.91	83.75	96.70

* Only available with code CC, BC or 29.

Code	Type of connection
CA	1/8 BSPT
BA	1/8 NPT
CC	1/4 BSPT
BC	1/4 NPT
29	Assembly with retaining nut 3/8 BSPP

Conversion formula for this series: $\dot{V}_2 = \dot{V}_1 \cdot \sqrt{\frac{p_2}{p_1}}$



Assembly accessories can be found in Chapter 9 "Accessories".

Ordering Series + Flow rate code + Material no. + Code = Ordering no.
example: 6FH + 541 + A3 + CA = 6FH.541.A3.CA

Low pressure flat fan nozzles with ball joint

Series 676

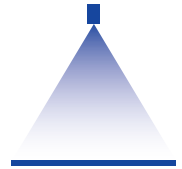

Features:

- Swivelling nozzle
- Precise spray alignment according to requirements
- Assembly with retaining nut, threaded socket, threaded nipple, welded nipple

Applications:

- Cleaning
- Cooling
- Lubrication



Series 676

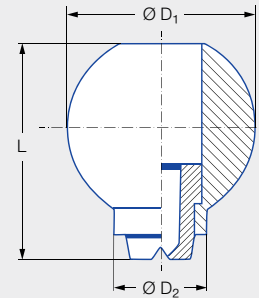

Dimensions [mm]			Weight [g] Brass	P _{max} [bar]
L	Ø D ₁	Ø D ₂		
25.0	22.0	11.0	45.0	30.0

Spray angle	Ordering no.	Mat. no.		Equivalent bore diameter A [mm]	Narrowest free cross section Ø [mm]	V̇ water [l/min]						Spray width B [mm] (at p = 5 bar)	
		16	30			p [bar]						H = 250 [mm]	H = 500 [mm]
						0.5	1.0	2.0	3.0	5.0	10.0		
20°	676.301	●	●	0.70	0.60	0.16*	0.23*	0.32	0.40	0.51	0.72	85	160
	676.361	●	●	1.00	0.80	0.32*	0.45*	0.63	0.77	1.00	1.41	85	160
	676.441	●	●	1.35	1.10	0.63*	0.89	1.25	1.53	1.98	2.80	85	160
	676.481	●	●	1.50	1.30	0.80*	1.13	1.60	1.96	2.53	3.58	85	160
30°	676.302	●	●	0.70	0.50	0.16*	0.23*	0.32	0.40	0.51	0.72	120	220
	676.362	●	●	1.00	0.80	0.32*	0.45*	0.63	0.77	1.00	1.41	120	220
	676.402	●	●	1.20	1.00	0.50*	0.71	1.00	1.22	1.58	2.23	120	230
	676.482	●	●	1.50	1.10	0.80*	1.13	1.60	1.96	2.53	3.58	130	230
	676.562	●	●	2.00	1.50	1.25	1.77	2.50	3.06	3.95	5.59	130	240
	676.642	●	●	2.50	1.80	2.00	2.83	4.00	4.90	6.33	8.95	140	250
	676.722	●	●	3.00	2.40	3.15	4.45	6.30	7.71	9.96	14.09	140	260
	676.762	●	●	3.50	2.70	4.00	5.66	8.00	9.80	12.65	17.89	140	260
676.802	●	●	4.00	3.10	5.00	7.07	10.00	12.25	15.81	22.36	140	260	
45°	676.303	●	●	0.70	0.50	0.16*	0.23*	0.32	0.40	0.51	0.72	170	330
	676.363	●	●	1.00	0.70	0.32*	0.45*	0.63	0.77	1.00	1.41	190	350
	676.403	●	●	1.20	0.90	0.50*	0.71	1.00	1.22	1.58	2.23	200	370
	676.483	●	●	1.50	1.10	0.80*	1.13	1.60	1.96	2.53	3.58	200	390
	676.563	●	●	2.00	1.40	1.25	1.77	2.50	3.06	3.95	5.59	210	410
	676.643	●	●	2.50	1.80	2.00	2.83	4.00	4.90	6.33	8.95	220	410
	676.723	●	●	3.00	2.40	3.15	4.45	6.30	7.71	9.96	14.09	220	420
	676.763	●	●	3.50	2.70	4.00	5.66	8.00	9.80	12.65	17.89	220	420
676.803	●	●	4.00	3.00	5.00	7.07	10.00	12.25	15.81	22.36	220	420	
60°	676.304	●	●	0.70	0.40	0.16*	0.23*	0.32	0.40	0.51	0.72	260	480
	676.334	●	●	0.90	0.50	0.22*	0.32*	0.45	0.55	0.71	1.00	260	490
	676.364	●	●	1.00	0.60	0.32*	0.45*	0.63	0.77	1.00	1.41	260	500
	676.404	●	●	1.20	0.80	0.50*	0.71	1.00	1.22	1.58	2.23	260	510
	676.444	●	●	1.35	1.00	0.63*	0.89	1.25	1.53	1.98	2.80	260	510
	676.484	●	●	1.50	1.00	0.80*	1.13	1.60	1.96	2.53	3.58	260	520

Spray angle	Ordering no.			Equivalent bore diameter A [mm]	Narrowest free cross section Ø [mm]	V̇ water [l/min]						Spray width B [mm] (at p = 5 bar)	
	Type	Mat. no.				p [bar]						H = 250 [mm]	H = 500 [mm]
		16	30			0.5	1.0	2.0	3.0	5.0	10.0		
		Stainless steel 303	Brass										
60°	676.514	●	●	1.65	1.10	0.95*	1.34	1.90	2.32	3.00	4.24	270	520
	676.564	●	●	2.00	1.30	1.25	1.77	2.50	3.06	3.95	5.59	270	530
	676.604	●	●	2.20	1.50	1.57	2.23	3.15	3.86	4.98	7.04	270	540
	676.644	●	●	2.50	1.60	2.00	2.83	4.00	4.90	6.33	8.95	270	540
	676.674	●	●	2.70	1.80	2.37	3.36	4.75	5.82	7.51	10.62	270	550
	676.724	●	●	3.00	2.10	3.15	4.45	6.30	7.71	9.96	14.09	280	560
676.764	●	●	3.50	2.30	4.00	5.66	8.00	9.80	12.65	17.89	280	570	
75°	676.145	●	●	0.20	0.12	–	0.04*	0.05	0.06	0.08	0.11	380	690
	676.165	●	●	0.20	0.08	–	0.05*	0.06	0.08	0.10	0.14	380	690
	676.185	●	●	0.20	0.15	–	0.06*	0.08	0.09	0.12	0.17	380	690
	676.215	●	●	0.40	0.20	–	0.08*	0.11	0.14	0.18	0.25	380	690
	676.245	●	●	0.50	0.30	–	0.12*	0.16	0.20	0.26	0.37	380	690
	676.275	●	●	0.60	0.30	0.11*	0.16*	0.22	0.27	0.35	0.49	380	690
90°	676.216	●	●	0.40	0.20	–	0.08*	0.11	0.14	0.18	0.25	420	780
	676.276	●	●	0.60	0.30	0.11*	0.16*	0.22	0.27	0.35	0.49	430	790
	676.306	●	●	0.70	0.40	0.16*	0.23*	0.32	0.40	0.51	0.72	440	800
	676.336	●	●	0.90	0.50	0.22*	0.32*	0.45	0.55	0.71	1.00	440	820
	676.366	●	●	1.00	0.50	0.32*	0.45*	0.63	0.77	1.00	1.41	450	830
	676.406	●	●	1.20	0.70	0.50*	0.71	1.00	1.22	1.58	2.23	450	840
	676.446	●	●	1.35	0.80	0.63*	0.89	1.25	1.53	1.98	2.80	460	860
	676.486	●	●	1.50	0.80	0.80*	1.13	1.60	1.96	2.53	3.58	470	870
	676.516	●	●	1.65	0.90	0.95*	1.34	1.90	2.32	3.00	4.24	480	880
	676.566	●	●	2.00	1.10	1.25	1.77	2.50	3.06	3.95	5.59	490	900
	676.606	●	●	2.20	1.20	1.57	2.23	3.15	3.86	4.98	7.04	500	910
	676.646	●	●	2.50	1.30	2.00	2.83	4.00	4.90	6.33	8.95	510	930
	676.676	●	●	2.70	1.40	2.37	3.36	4.75	5.82	7.51	10.62	510	950
	676.726	●	●	3.00	1.70	3.15	4.45	6.30	7.71	9.96	14.09	520	980
120°	676.187	●	●	0.35	0.20	–	0.06*	0.08	0.10	0.13	0.18	630	1,060
	676.217	●	●	0.40	0.20	–	0.08*	0.11	0.14	0.18	0.25	650	1,080
	676.247	●	●	0.50	0.20	–	0.12*	0.16	0.20	0.26	0.37	660	1,100
	676.277	●	●	0.60	0.30	–	0.16*	0.22	0.27	0.35	0.49	670	1,150
	676.307	●	●	0.70	0.30	0.16*	0.23*	0.32	0.40	0.51	0.72	710	1,240
	676.337	●	●	0.90	0.40	0.22*	0.32*	0.45	0.55	0.71	1.00	740	1,350
	676.367	●	●	1.00	0.50	0.32*	0.45*	0.63	0.77	1.00	1.41	800	1,430
	676.407	●	●	1.20	0.60	0.50*	0.71	1.00	1.22	1.58	2.23	830	1,480
	676.447	●	●	1.35	0.70	0.63*	0.89	1.25	1.53	1.98	2.80	840	1,520
	676.487	●	●	1.50	0.60	0.80*	1.13	1.60	1.96	2.53	3.58	850	1,540
	676.517	●	●	1.65	0.90	0.95*	1.34	1.90	2.32	3.00	4.24	850	1,560
	676.567	●	●	2.00	0.90	1.25	1.77	2.50	3.06	3.95	5.59	870	1,590
	676.607	●	●	2.20	1.10	1.57	2.23	3.15	3.86	4.98	7.04	870	1,620
	676.647	●	●	2.50	1.30	2.00	2.83	4.00	4.90	6.33	8.95	880	1,640
	676.677	●	●	2.70	1.40	2.37	3.36	4.75	5.82	7.51	10.62	890	1,660
	676.727	●	●	3.00	1.60	3.15	4.45	6.30	7.71	9.96	14.09	890	1,680
	676.767	●	●	3.50	1.70	4.00	5.66	8.00	9.80	12.65	17.89	900	1,700

* Differing spray pattern.

Conversion formula for this series: $\dot{V}_2 = \dot{V}_1 \cdot \sqrt{\frac{p_2}{p_1}}$ Ordering Type + Material no. = Ordering no.
example: 676.514 + 16 = 676.514.16

Assembly accessories can be found in Chapter 9 "Accessories".

➤ Nozzle systems for surface treatment

Series 676/677 MEMOSPRAY

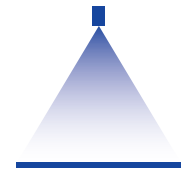

Features:

- Retention of the adjusted spray direction when changing nozzles
- Simple, quick nozzle assembly without the need for tools
- Many combination options
- Large range of flow rates, spray angles and materials



Applications:

- Degreasing
- Phosphating in surface treatment
- Industrial cleaning
- Container washers

Assembly example



① a Flat fan nozzle

Incl. gasket 095.015.7A.05.65
(Material: Viton)

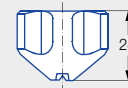

Designation	Spray angle	Ordering no.				Narrowest free cross section Ø [mm]	V̇ [l/min]					Weight [g]				
		Mat. no.					p [bar]					PP/Stainless steel 303	PP/Stainless steel 316L	PP/Ceramic	Polypropylene (PP)	
		Type	8F Housing: PP Insert: 303 SS	8R Housing: PP Insert: 316L SS	E8 Housing: PP Insert: Ceramic		53 Polypropylene (PP)	1.0	1.5	2.0	2.5					5.0
① a Flat fan nozzle	30°	676.642.xx.40	●	●			1.60	2.83	3.46	4.00	4.47	6.33	15.00	15.00	-	-
		676.722.xx.40	●	●			2.10	4.46	5.46	6.30	7.04	9.96	15.00	15.00	-	-
		676.762.xx.40	●	●			2.30	5.66	6.93	8.00	8.94	12.65	15.00	15.00	-	-
		676.802.xx.40	●	●			2.60	7.07	8.66	10.00	11.18	15.81	15.00	15.00	-	-
		676.842.xx.40	●	●			3.00	8.84	10.82	12.50	13.97	19.76	15.00	15.00	-	-
		676.882.xx.40	●	●			3.40	11.31	13.86	16.00	17.89	25.30	15.00	15.00	-	-
		676.922.xx.40	●	●			4.10	14.14	17.32	20.00	22.36	31.62	15.00	15.00	-	-
		676.962.xx.40	●	●			4.20	17.68	21.65	25.00	27.95	39.53	15.00	15.00	-	-
	677.002.xx.40	●				4.70	22.27	27.28	31.50	35.22	49.81	15.00	-	-	-	
	60°	676.644.xx.40	●	●			1.60	2.83	3.46	4.00	4.47	6.33	15.00	15.00	-	-
		676.724.xx.40	●	●			2.10	4.46	5.46	6.30	7.04	9.96	15.00	15.00	-	-
		676.764.xx.40	●	●			2.30	5.66	6.93	8.00	8.94	12.65	15.00	15.00	-	-
		676.804.xx.40	●	●			2.60	7.07	8.66	10.00	11.18	15.81	15.00	15.00	-	-
		676.844.xx.40	●	●			3.00	8.84	10.82	12.50	13.97	19.76	15.00	15.00	-	-
		676.884.xx.40	●	●	●	●	3.40	11.31	13.86	16.00	17.89	25.30	15.00	15.00	10.00	8.00
		676.924.xx.40	●	●	●	●	4.10	14.14	17.32	20.00	22.36	31.62	15.00	15.00	10.00	8.00
676.964.xx.40		●	●	●	●	4.20	17.68	21.65	25.00	27.95	39.53	15.00	15.00	10.00	8.00	
677.004.xx.40	●	●	●	●	4.70	22.27	27.28	31.50	35.22	49.81	15.00	15.00	10.00	8.00		
677.044.xx.40	●	●			5.50	28.28	34.64	40.00	44.72	63.25	15.00	15.00	-	-		
677.084.xx.40	●	●			6.20	35.36	43.30	50.00	55.90	79.06	15.00	15.00	-	-		

Designation	Spray angle	Ordering no.					Narrowest free cross section \varnothing [mm]	\dot{V} [l/min]					Weight [g]			
		Type	Mat. no.					p [bar]					PP/Stainless steel 303	PP/Stainless steel 316L	PP/Ceramic	Polypropylene (PP)
			8F	8R	E8	53		1.0	1.5	2.0	2.5	5.0				
① a Flat fan nozzle	90°	676.646.xx.40	●	●			1.60	2.83	3.46	4.00	4.47	6.33	15.00	15.00	-	-
		676.726.xx.40	●	●			2.10	4.46	5.46	6.30	7.04	9.96	15.00	15.00	-	-
		676.766.xx.40	●	●			2.30	5.66	6.93	8.00	8.94	12.65	15.00	15.00	-	-
		676.806.xx.40	●	●			2.60	7.07	8.66	10.00	11.18	15.81	15.00	15.00	-	-
		676.846.xx.40	●	●			3.00	8.84	10.82	12.50	13.97	19.76	15.00	15.00	-	-
		676.886.xx.40	●	●			3.40	11.31	13.86	16.00	17.89	25.30	15.00	15.00	-	-
		676.926.xx.40	●	●			4.10	14.14	17.32	20.00	22.36	31.62	15.00	15.00	-	-
	676.966.xx.40	●	●			4.20	17.68	21.65	25.00	27.95	39.53	15.00	15.00	-	-	
	120°	676.647.xx.40	●	●			1.60	2.83	3.46	4.00	4.47	6.33	15.00	15.00	-	-
		676.727.xx.40	●	●			2.10	4.46	5.46	6.30	7.04	9.96	15.00	15.00	-	-
		676.767.xx.40	●	●			2.30	5.66	6.93	8.00	8.94	12.65	15.00	15.00	-	-
		676.807.xx.40	●	●			2.60	7.07	8.66	10.00	11.18	15.81	15.00	15.00	-	-
		676.847.xx.40	●	●			3.00	8.84	10.82	12.50	13.97	19.76	15.00	15.00	-	-
		676.887.xx.40	●	●			3.40	11.31	13.86	16.00	17.89	25.30	15.00	15.00	-	-
676.927.xx.40		●	●			4.10	14.14	17.32	20.00	22.36	31.62	15.00	15.00	-	-	
Blind nozzle	-	067.630.8F.40.01	●			-	-	-	-	-	-	15.00	-	-	-	

① b Tongue-type nozzle

Incl. gasket 095.015.7A.05.65
(Material: Viton)

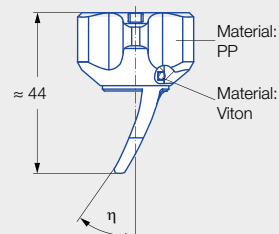

Designation	Spray angle	η	Ordering no.			Narrowest free cross section \varnothing [mm]	\dot{V} [l/min]					Weight [g]	
			Type	Mat. no.			p [bar]					PP/Stainless steel 316L	PVDF
				8R	5E		1.0	1.5	2.0	2.5	5.0		
① b Tongue-type nozzle	45°	35°	676.803.xx.41	●		3.40	7.07	8.66	10.00	11.18	15.81	25.00	-
	60°	35°	676.874.xx.41	●		4.20	10.61	12.99	15.00	16.77	23.72	25.00	-
	60°	35°	676.924.xx.41	●		4.70	14.14	17.32	20.00	22.36	31.62	25.00	-
	70°	40°	677.005.xx.41	●	●	6.00	22.27	27.28	31.50	35.22	49.81	25.00	11.00



Ordering Type + Material no. = Ordering no.
example: 676.646.xx.40 + 8F = 676.646.8F.40

Conversion formula for this series: $\dot{V}_2 = \dot{V}_1 \cdot \sqrt{\frac{p_2}{p_1}}$



② a Retaining nut

092.080.xx.00.02

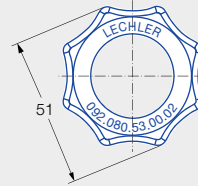

② b Retaining nut

067.600.xx.40

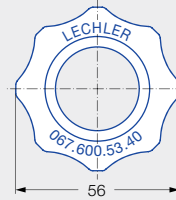

③ Ball bayonet base

067.630.xx.40

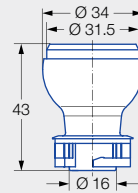

④ a Ball seat

067.631.xx.40.x2

For eyelet clamp
067.631.xx.40.00

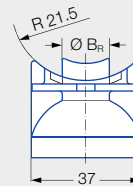

④ b Ball seat

067.631.xx.50.x2

For eyelet clamp
067.631.xx.50.00

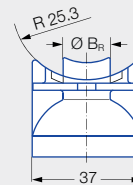

Designation	Ordering no.			Ø B _R ¹ [mm]	Recommended bore diameter [mm]	Pipe Ø [mm]	Weight [g]
	Type	Mat. no.					
		53	6M				
② a Retaining nut	092.080.xx.00.02	●		-	-	-	18.0
② b Retaining nut	067.600.xx.40	●		-	-	-	18.0
③ Ball bayonet base	067.630.xx.40	●		-	-	-	12.0
④ a Ball seat for eyelet clamp no. 067.631.xx.40.00	067.631.xx.40.22		●	13.8	14.0–14.3	1 1/4" (40.0–43.0)	9.0
	067.631.xx.40.02		●	16.0	16.5–17.0	1 1/4" (40.0–43.0)	11.0
	067.631.xx.40.12		●	19.8	20.3–20.8	1 1/4" (40.0–43.0)	13.0
④ b Ball seat for eyelet clamp no. 067.631.xx.50.00	067.631.xx.50.22		●	13.8	14.0–14.3	1 1/2" (46.0–49.0)	9.0
	067.631.xx.50.02		●	16.0	16.5–17.0	1 1/2" (46.0–49.0)	11.0
	067.631.xx.50.12		●	19.8	20.3–20.8	1 1/2" (46.0–49.0)	13.0

¹ Ø B_R = spigot diameter.

⑤ a Eyelet clamp

067.631.xx.x0.00

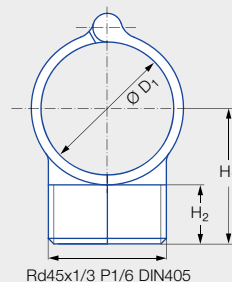
⑤ b Eyelet clamp

090.0x3.xx.4x.10

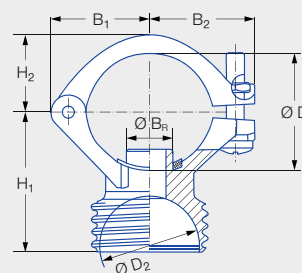
⑤ c Single clamp

092.08x.xx.00

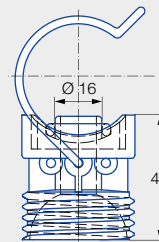

Designation	Ordering no.		Dimensions [mm]						Ø B _R ¹ [mm]	Recommend- ed bore diameter [mm]	Pipe Ø (Ø D) [mm]	Weight [g]
	Type	Mat. no.	B ₁	B ₂	H ₁	H ₂	Ø D ₁	Ø D ₂				
		Polypropyl- ene (PP) 53										
⑤ a Eyelet clamp	067.631.xx.40.00	●	-	-	47.7	22.0	43.0	-	-	-	1 1/4" (40.0-43.0)	31.0
	067.631.xx.50.00	●	-	-	51.5	22.0	50.6	-	-	-	1 1/2" (46.0-49.0)	33.0
⑤ b Eyelet clamp	090.023.xx.44.10	●	30.0	32.0	44.5	23.0	-	34.0	13.8	14.0-14.3	1" (32.0-34.5)	48.0
	090.023.xx.43.10	●	30.0	32.0	44.5	23.0	-	34.0	16.0	16.5-17.0	1" (32.0-34.5)	48.0
	090.033.xx.44.10	●	33.0	36.0	48.0	27.0	-	34.0	13.8	14.0-14.3	1 1/4" (40.0-43.0)	50.0
	090.033.xx.43.10	●	33.0	36.0	48.0	27.0	-	34.0	16.0	16.5-17.0	1 1/4" (40.0-43.0)	50.0
	090.033.xx.40.10	●	33.0	36.0	48.0	27.0	-	34.0	20.0	20.5-21.0	1 1/4" (40.0-43.0)	50.0
	090.043.xx.44.10	●	36.0	35.0	52.0	30.0	-	34.0	13.8	14.0-14.3	1 1/2" (46.0-49.0)	52.0
	090.043.xx.43.10	●	36.0	35.0	52.0	30.0	-	34.0	16.0	16.5-17.0	1 1/2" (46.0-49.0)	52.0
	090.043.xx.40.10	●	36.0	35.0	52.0	30.0	-	34.0	20.0	20.5-21.0	1 1/2" (46.0-49.0)	52.0
⑤ c Single clamp	092.080.xx.00	●	-	-	-	-	-	-	16.3*	16.5-17.0	1" (32.0-34.5)	36.0
	092.081.xx.00	●	-	-	-	-	-	-	16.3*	16.5-17.0	1 1/4" (40.0-43.0)	38.0
	092.082.xx.00	●	-	-	-	-	-	-	16.3*	16.5-17.0	1 1/2" (46.0-49.0)	40.0
	092.083.xx.00	●	-	-	-	-	-	-	16.3*	16.5-17.0	2" (58.0-62.0)	42.0

* Other spigot diameters available on request.

¹ Ø B_R = spigot diameter.

Ordering Type + Material no. = Ordering no.
 example: 067.631.xx.40.00 + 53 = 067.631.53.40.00

Conversion formula for this series: $\dot{V}_2 = \dot{V}_1 \cdot \sqrt{\frac{P_2}{P_1}}$

➤ Nozzle systems for surface treatment

Series 676 Easy-Clip

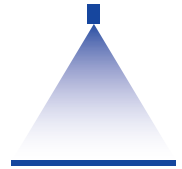

Features:

- Simple, quick nozzle assembly without the need for tools
- All-round 30° swivelling
- Easy adjustment and cleaning



Applications:

- Degreasing
- Phosphating in surface treatment
- Industrial cleaning
- Container washers

Materials:

- Clamp: Stainless steel 301
- Gasket: EPDM
- Cylinder pin, screw, screw unit: Stainless steel 316L
- Body, retaining nut: Polypropylene, glass fibre reinforced
- Ball nozzle, ball joint: Polypropylene

Assembly example

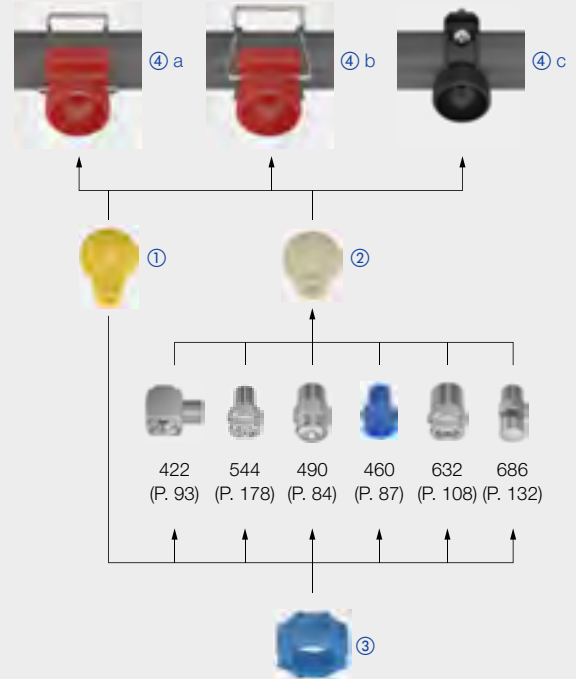

Sets – series 676 Easy-Clip

Designation	Spray angle	Ordering no.	Nozzle Color	V̇ [l/min]				
				p [bar]				
				0.5	1.0	1.5	2.0	2.5
Set 1 consisting of: Ball nozzle Single clamp for 1 1/4" pipe Retaining nut	60°	676.724.53.31	Grey	3.15	4.45	5.45	6.30	7.04
		676.764.53.31	Brown	4.00	5.66	6.93	8.00	8.94
		676.804.53.31	Purple	5.00	7.07	8.66	10.00	11.18
		676.844.53.31	Yellow	6.25	8.84	10.83	12.50	13.98
		676.884.53.31	Red	8.00	11.31	13.85	16.00	17.89
		676.904.53.31	Blue	9.10	12.87	15.76	18.20	20.35
		676.924.53.31	Green	10.00	14.14	17.32	20.00	22.36

Designation	Ordering no.	Ball Color	BSPP	Matches series
Set 2 consisting of: Ball joint Single clamp for 1 1/4" pipe Retaining nut	092.081.53.AB	Beige	1/8	460, 490, 632, 686, 610, 544
	092.081.53.AD	Beige	1/4	422, 460, 490, 544, 612, 632, 686
	092.081.53.AF	Beige	3/8	422, 460, 490, 632, 686, 688
	092.081.53.AH	Beige	1/2	422, 460, 490, 632, 686

Individual parts – series 676 Easy-Clip

① Ball nozzle

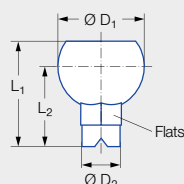

Dimensions [mm]				
L ₁	L ₂	Ø D ₁	Ø D ₂	Flats
41.5	31.5	34.0	15.0	16.0

Designation	Spray angle	Ordering no. Type	Nozzle Color	V̇ [l/min]				
				p [bar]				
				0.5	1.0	1.5	2.0	2.5
① Ball nozzle	60°	676.724.53.30.01	Grey	3.15	4.45	5.45	6.30	7.04
		676.764.53.30.01	Brown	4.00	5.66	6.93	8.00	8.94
		676.804.53.30.01	Purple	5.00	7.07	8.66	10.00	11.18
		676.844.53.30.01	Yellow	6.25	8.84	10.83	12.50	13.98
		676.884.53.30.01	Red	8.00	11.31	13.85	16.00	17.89
		676.904.53.30.01	Blue	9.10	12.87	15.67	18.20	20.35
		676.924.53.30.01	Green	10.00	14.14	17.32	20.00	22.36
Blind nozzle	–	092.080.53.00.01	Grey	–	–	–	–	–

② Ball joint

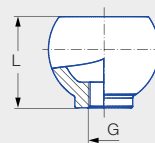

Designation	Ordering no.	Ball Color	BSPB	L [mm]	Matches series
	Type				
② Ball joint	092.080.53.AB.01	Beige	1/8	28.4	460, 490, 632, 686, 610, 544
	092.080.53.AD.01	Beige	1/4	32.4	422, 460, 490, 544, 612, 632, 686
	092.080.53.AF.01	Beige	3/8	31.4	422, 460, 490, 632, 686, 688
	092.080.53.AH.01	Beige	1/2	33.0	422, 460, 490, 632, 686

③ Retaining nut

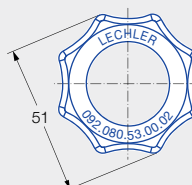

Designation	Ordering no.
	Type
③ Retaining nut	092.080.53.00.02



➤ Nozzle systems for surface treatment

Series 676 Easy-Clip

④ a Single clamp

092.08x.53.00

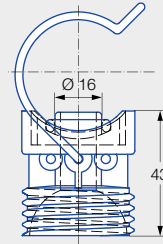

④ b Double clamp

092.09x.53.00

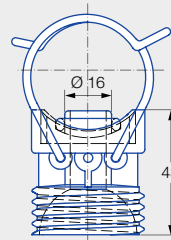

④ c Eyelet clamp

090.0x3.53.43.10

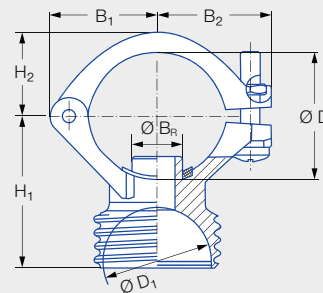

Designation	Ordering no.	Dimensions [mm]					Ø B _R ¹ [mm]	Recommend- ed bore diameter [mm]	Pipe Ø (Ø D) [mm]	Weight [g]
		B ₁	B ₂	H ₁	H ₂	Ø D ₁				
④ a Single clamp	092.080.53.00	-	-	-	-	-	16.3*	16.5-17.0	1" (32.0-34.5)	36.0
	092.081.53.00	-	-	-	-	-	16.3*	16.5-17.0	1 1/4" (40.0-43.0)	38.0
	092.082.53.00	-	-	-	-	-	16.3*	16.5-17.0	1 1/2" (46.0-49.0)	40.0
	092.083.53.00	-	-	-	-	-	16.3*	16.5-17.0	2" (58.0-62.0)	42.0
④ b Double clamp	092.090.53.00	-	-	-	-	-	16.3*	16.5-17.0	1" (32.0-34.5)	46.0
	092.091.53.00	-	-	-	-	-	16.3*	16.5-17.0	1 1/4" (40.0-43.0)	48.0
	092.092.53.00	-	-	-	-	-	16.3*	16.5-17.0	1 1/2" (46.0-49.0)	50.0
	092.093.53.00	-	-	-	-	-	16.3*	16.5-17.0	2" (58.0-62.0)	52.0
④ c Eyelet clamp	090.023.53.43.10	30.0	32.0	44.5	23.0	34.0	16.3**	16.5-17.0	1" (32.0-34.5)	48.0
	090.033.53.43.10	33.0	36.0	48.0	27.0	34.0	16.3**	16.5-17.0	1 1/4" (40.0-43.0)	50.0
	090.043.53.43.10	36.0	35.0	52.0	30.0	34.0	16.3**	16.5-17.0	1 1/2" (46.0-49.0)	52.0

* Other spigot diameters (13.8/19.0 mm) available on request.

** Other spigot diameters (13.8/20.0 mm) available on request.

¹ Ø B_R = spigot diameter.





➤➤ SOLID STREAM NOZZLES

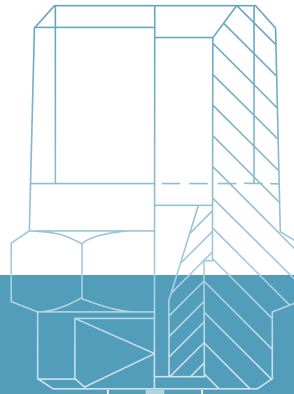

» SOLID STREAM NOZZLES OVERVIEW OF TYPES



Lechler solid stream nozzles are characterized by a stable and powerful jet stream, with low pressure and high pressure variants available. When concentrated spray power is required, e.g. in cleaning processes, the precision of Lechler solid stream nozzles enhances the productivity and performance for every installation.

Low pressure and high pressure solid stream nozzles



- Concentrated solid jet stream, minimal atomization
- High impact
- Suitable for cleaning and washing processes
- Injection
- Targeted cooling
- Pasteurization

International nozzle code





High pressure solid stream nozzle designations are governed by international standards. The two digits specify the flow rate in US gallons per minute at 40 psi. Our high pressure solid stream nozzles (series 546/548/550) are specified with this international nozzle code.

02

Flow rate in US gal/min at 40 psi
Conversion: Value · 3.22 = flow rate in l/min at 2 bar
example: 0.2 gal/min at 40 psi = 0.644 l/min at 2 bar

SOLID STREAM NOZZLES OVERVIEW OF SERIES



		Solid stream nozzles			
					
Series		544	546	548	550
Information on page		154	155	156	157
Pressure range	Low pressure	•			
	High pressure		•	•	•
Flow rate	Low ≤ 20 l/min	• (at p = 5 bar)	• (at p = 80 bar)	• (at p = 80 bar)	• (at p = 80 bar)
	High > 20 l/min		• (at p = 80 bar)	• (at p = 80 bar)	• (at p = 80 bar)
Nozzle material	Stainless steel	•	•	•	•
	Brass	•			
Nozzle connection		1/8 BSPT 1/4 BSPT	1/4 BSPT 1/4 NPT	Assembly with retaining nut 3/8 BSPP	1/8 BSPT 1/8 NPT

Low pressure solid stream nozzles

Series 544

Properties:

- Concentrated solid stream jet
- High impact

Applications:

- Cleaning and washing processes
- Injection
- Targeted cooling
- Pasteurization



Series 544

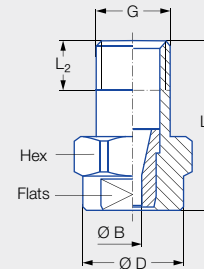

Code	G	Dimensions [mm]					Weight [g] (Brass)
		L ₁	L ₂	Ø D	Hex	Flats	
CA	1/8 BSPT	22.0	6.5	13.0	14	10	14.0
CC	1/4 BSPT	22.0	10.0	13.0	14	10	16.0

Type	Ordering no.		Code		Bore diameter B [mm]	V̇ water [l/min]								
	Mat. no.		1/8 BSPT	1/4 BSPT		p [bar]								
	16	30				0.5	1.0	2.0	3.0	5.0	10.0	15.0	20.0	30.0
	Stainless steel 303	Brass												
544.110	●	●	CA	CC	0.23	0.02	0.03	0.04	0.05	0.06	0.08	0.10	0.12	0.15
544.160	●		CA	CC	0.33	0.03	0.04	0.06	0.07	0.09	0.13	0.16	0.18	0.22
544.200	●	●	CA	CC	0.39	0.05	0.07	0.10	0.12	0.16	0.23	0.28	0.32	0.39
544.240	●		CA	CC	0.50	0.08	0.11	0.16	0.19	0.25	0.35	0.43	0.50	0.61
544.280	●		CA	CC	0.63	0.13	0.18	0.25	0.31	0.40	0.57	0.69	0.80	0.98
544.320	●	●	CA	CC	0.80	0.20	0.28	0.40	0.49	0.63	0.89	1.09	1.26	1.54
544.360	●	●	CA	CC	1.05	0.32	0.45	0.63	0.77	1.00	1.41	1.73	2.00	2.45
544.400	●	●	CA	CC	1.30	0.50	0.71	1.00	1.22	1.58	2.23	2.74	3.16	3.87
544.480	●	●	CA	CC	1.33	0.80	1.13	1.60	1.96	2.53	3.58	4.38	5.06	6.20
544.560	●	●	CA	CC	1.65	1.25	1.77	2.50	3.06	3.95	5.59	6.84	7.90	9.68
544.640	●	●	CA	CC	2.09	2.00	2.83	4.00	4.90	6.32	8.94	10.95	12.64	15.48
544.720	●	●	CA	CC	2.66	3.15	4.45	6.30	7.71	9.96	14.09	17.25	19.92	24.40
544.800	●	●	CA	CC	3.30	5.00	7.07	10.00	12.25	15.81	22.36	27.38	31.62	38.73

Conversion formula for this series: $\dot{V}_2 = \dot{V}_1 \cdot \sqrt{\frac{p_2}{p_1}}$

Ordering Type + Material no. + Code = Ordering no.
example: 544.110 + 16 + CA = 544.110.16.CA

 Assembly accessories can be found in Chapter 9 "Accessories".

High pressure solid stream nozzles

Series 546

Properties:

- Concentrated solid stream jet
- High impact
- Housing 303 SS, insert: Hardened stainless steel 420F

Applications:

- Cleaning and washing processes

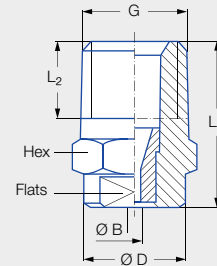

Series 546

G	Dimensions [mm]					Weight [g]	p _{max} ¹ [bar]
	L ₁	L ₂	Ø D	Hex	Flats		
1/4 BSPT	22.0	10.0	13.0	14	10	18.0	approx. 700
1/4 NPT	22.0	10.0	13.0	14	10	18.0	approx. 700

¹ Applies only to operation at constant pressure.

US gal/min at 40 psi	Ordering no.			Bore diameter B [mm]	V̇ water [l/min]							
	Type	Code			p [bar]							
		1/4 BSPT	1/4 NPT		40	60	80	100	120	150	200	300
01	546.300.A3	00	07	0.60	1.44	1.77	2.04	2.28	2.50	2.79	3.22	3.95
02	546.360.A3	00	07	0.84	2.88	3.53	4.08	4.56	5.00	5.58	6.45	7.90
025	546.380.A3	00	07	0.94	3.60	4.42	5.10	5.70	6.24	6.98	8.06	9.87
027	546.390.A3	00	07	0.99	3.89	4.76	5.50	6.15	6.74	7.53	8.70	10.65
03	546.400.A3	00	07	1.03	4.33	5.30	6.12	6.84	7.49	8.38	9.67	11.85
034	546.410.A3	00	07	1.07	4.90	6.00	6.93	7.75	8.49	9.49	10.96	13.42
035	546.420.A3	00	07	1.11	5.05	6.18	7.14	7.98	8.74	9.77	11.29	13.82
038	546.440.A3	00	07	1.15	5.48	6.71	7.75	8.66	9.49	10.61	12.25	15.00
04	546.450.A3	00	07	1.19	5.77	7.06	8.16	9.12	9.99	11.17	12.90	15.80
045	546.470.A3	00	07	1.26	6.49	7.95	9.18	10.26	11.24	12.57	14.51	17.77
05	546.480.A3	00	07	1.33	7.21	8.83	10.20	11.40	12.49	13.96	16.12	19.75
055	546.500.A3	00	07	1.39	7.93	9.71	11.22	12.54	13.74	15.36	17.73	21.72
06	546.520.A3	00	07	1.46	8.65	10.60	12.24	13.68	14.99	16.75	19.35	23.69
065	546.530.A3	00	07	1.51	9.37	11.48	13.26	14.82	16.23	18.15	20.96	25.67
070	546.540.A3	00	07	1.58	10.09	12.36	14.28	15.96	17.48	19.55	22.57	27.64
074	546.550.A3	00	07	1.62	10.67	13.07	15.09	16.87	18.48	20.66	23.86	29.22
08	546.570.A3	00	07	1.69	11.54	14.13	16.31	18.24	19.98	22.34	25.80	31.59
087	546.580.A3	00	07	1.76	12.54	15.36	17.74	19.83	21.72	24.29	28.04	34.35
089	546.590.A3	00	07	1.78	12.83	15.72	18.15	20.29	22.23	24.85	28.69	35.14
10	546.600.A3	00	07	1.88	14.41	17.65	20.38	22.79	24.97	27.91	32.23	39.47
11	546.620.A3	00	07	1.97	15.86	19.42	22.42	25.07	27.46	30.70	35.45	43.42
124	546.640.A3	00	07	2.09	17.87	21.89	25.28	28.26	30.96	34.61	39.97	48.95
131	546.650.A3	00	07	2.15	18.89	23.13	26.71	29.86	32.71	36.57	42.23	51.72
139	546.660.A3	00	07	2.22	20.04	24.54	28.34	31.68	34.70	38.80	44.80	54.87
15	546.670.A3	00	07	2.30	21.62	26.48	30.58	34.19	37.45	41.87	48.35	59.22
165	546.690.A3	00	07	2.41	23.79	29.13	33.64	37.61	41.20	46.06	53.19	65.14
174	546.700.A3	00	07	2.48	25.08	30.72	35.47	39.66	43.45	48.57	56.09	68.69
183	546.710.A3	00	07	2.55	26.38	32.31	37.31	41.71	45.69	51.08	58.99	72.24
20	546.720.A3	00	07	2.66	28.83	35.31	40.78	45.59	49.94	55.84	64.47	78.96
218	546.740.A3	00	07	2.77	31.43	38.49	44.44	49.69	54.43	60.86	70.27	86.07
25	546.760.A3	00	07	2.96	36.04	44.14	50.97	56.99	62.43	69.80	80.60	98.71
294	546.790.A3	00	07	3.22	42.38	51.91	59.94	67.01	73.41	82.07	94.77	116.06
310	546.800.A3	00	07	3.30	44.69	54.73	63.20	70.66	77.40	86.54	99.93	122.39

Conversion formula for this series: $\dot{V}_2 = \dot{V}_1 \cdot \sqrt{\frac{p_2}{p_1}}$

Ordering Type + Code = Ordering no.
example: 546.300.A3 + 00 = 546.300.A3.00

Assembly accessories can be found in Chapter 9 "Accessories".

High pressure solid stream nozzles

Series 548

Properties:

- Concentrated solid stream jet
- High impact
- Housing 303 SS, insert: Hardened stainless steel 420F
- Assembly with retaining nut

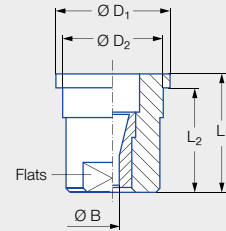

Applications:

- Cleaning and washing processes

Series 548

Code	Dimensions [mm]					Weight [g]	p _{max} ¹ [bar]
	L ₁	L ₂	Ø D ₁	Ø D ₂	Flats		
Assembly with retaining nut 3/8 BSPP	16.00	14.00	14.80	12.65	10	13.00	approx. 300

¹ Applies only to operation at constant pressure.

US gal/min at 40 psi	Ordering no. Type	Bore diameter B [mm]	V̇ water [l/min]							
			p [bar]							
			40	60	80	100	120	150	200	300
01	548.300.A3.29	0.60	1.44	1.77	2.04	2.28	2.50	2.79	3.22	3.95
02	548.360.A3.29	0.84	2.88	3.53	4.08	4.56	5.00	5.58	6.45	7.90
025	548.380.A3.29	0.94	3.60	4.42	5.10	5.70	6.24	6.98	8.06	9.87
027	548.390.A3.29	0.99	3.89	4.76	5.50	6.15	6.74	7.53	8.70	10.65
03	548.400.A3.29	1.03	4.33	5.30	6.12	6.84	7.49	8.38	9.67	11.85
034	548.410.A3.29	1.07	4.90	6.00	6.93	7.75	8.49	9.49	10.96	13.42
035	548.420.A3.29	1.11	5.05	6.18	7.14	7.98	8.74	9.77	11.29	13.82
038	548.440.A3.29	1.15	5.48	6.71	7.75	8.66	9.49	10.61	12.25	15.00
04	548.450.A3.29	1.19	5.77	7.06	8.16	9.12	9.99	11.17	12.90	15.80
045	548.470.A3.29	1.26	6.49	7.95	9.18	10.26	11.24	12.57	14.51	17.77
05	548.480.A3.29	1.33	7.21	8.83	10.20	11.40	12.49	13.96	16.12	19.75
055	548.500.A3.29	1.39	7.93	9.71	11.22	12.54	13.74	15.36	17.73	21.72
06	548.520.A3.29	1.46	8.65	10.60	12.24	13.68	14.99	16.75	19.35	23.69
065	548.530.A3.29	1.51	9.37	11.48	13.26	14.82	16.23	18.15	20.96	25.67
070	548.540.A3.29	1.58	10.09	12.36	14.28	15.96	17.48	19.55	22.57	27.64
074	548.550.A3.29	1.62	10.67	13.07	15.09	16.87	18.48	20.66	23.86	29.22
08	548.570.A3.29	1.69	11.54	14.13	16.31	18.24	19.98	22.34	25.80	31.59
087	548.580.A3.29	1.76	12.54	15.36	17.74	19.83	21.72	24.29	28.04	34.35
089	548.590.A3.29	1.78	12.83	15.72	18.15	20.29	22.23	24.85	28.69	35.14
10	548.600.A3.29	1.88	14.41	17.65	20.38	22.79	24.97	27.91	32.23	39.47
11	548.620.A3.29	1.97	15.86	19.42	22.42	25.07	27.46	30.70	35.45	43.42
124	548.640.A3.29	2.09	17.87	21.89	25.28	28.26	30.96	34.61	39.97	48.95
131	548.650.A3.29	2.15	18.89	23.13	26.71	29.86	32.71	36.57	42.23	51.72
139	548.660.A3.29	2.22	20.04	24.54	28.34	31.68	34.70	38.80	44.80	54.87
15	548.670.A3.29	2.30	21.62	26.48	30.58	34.19	37.45	41.87	48.35	59.22
165	548.690.A3.29	2.41	23.79	29.13	33.64	37.61	41.20	46.06	53.19	65.14
174	548.700.A3.29	2.48	25.08	30.72	35.47	39.66	43.45	48.57	56.09	68.69
183	548.710.A3.29	2.55	26.38	32.31	37.31	41.71	45.69	51.08	58.99	72.24
20	548.720.A3.29	2.66	28.83	35.31	40.78	45.59	49.94	55.84	64.47	78.96
218	548.740.A3.29	2.77	31.43	38.49	44.44	49.69	54.43	60.86	70.27	86.07
25	548.760.A3.29	2.96	36.04	44.14	50.97	56.99	62.43	69.80	80.60	98.71
294	548.790.A3.29	3.22	42.38	51.91	59.94	67.01	73.41	82.07	94.77	116.06
310	548.800.A3.29	3.30	44.69	54.73	63.20	70.66	77.40	86.54	99.93	122.39

Conversion formula for this series: $\dot{V}_2 = \dot{V}_1 \cdot \sqrt{\frac{P_2}{P_1}}$

Assembly accessories can be found in Chapter 9 "Accessories".

High pressure solid stream nozzles

Series 550

Properties:

- Concentrated solid stream jet
- High impact
- Housing 303, insert: Hardened stainless steel 1.4034 S

Applications:

- Cleaning and washing processes



Series 550

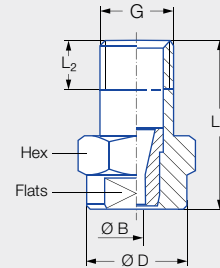

G	Dimensions [mm]					Weight [g]	p _{max} ¹ [bar]
	L ₁	L ₂	Ø D	Hex	Flats		
1/8 BSPT	22.0	6.5	13.0	14	10	13.0	approx. 700
1/8 NPT	22.0	6.5	13.0	14	10	13.0	approx. 700

¹ Applies only to operation at constant pressure.

US gal/min at 40 psi	Ordering no.			Bore diameter B [mm]	V̇ water [l/min]							
	Type	Code			p [bar]							
		1/8 BSPT	1/8 NPT		40	60	80	100	120	150	200	300
01	550.300.A3	00	07	0.60	1.44	1.77	2.04	2.28	2.50	2.79	3.22	3.95
02	550.360.A3	00	07	0.84	2.88	3.53	4.08	4.56	5.00	5.58	6.45	7.90
025	550.380.A3	00	07	0.94	3.60	4.42	5.10	5.70	6.24	6.98	8.06	9.87
027	550.390.A3	00	07	0.99	3.89	4.76	5.50	6.15	6.74	7.53	8.70	10.65
03	550.400.A3	00	07	1.03	4.33	5.30	6.12	6.84	7.49	8.38	9.67	11.85
034	550.410.A3	00	07	1.07	4.90	6.00	6.93	7.75	8.49	9.49	10.96	13.42
035	550.420.A3	00	07	1.11	5.05	6.18	7.14	7.98	8.74	9.77	11.29	13.82
038	550.440.A3	00	07	1.15	5.48	6.71	7.75	8.66	9.49	10.61	12.25	15.00
04	550.450.A3	00	07	1.19	5.77	7.06	8.16	9.12	9.99	11.17	12.90	15.80
045	550.470.A3	00	07	1.26	6.49	7.95	9.18	10.26	11.24	12.57	14.51	17.77
05	550.480.A3	00	07	1.33	7.21	8.83	10.20	11.40	12.49	13.96	16.12	19.75
055	550.500.A3	00	07	1.39	7.93	9.71	11.22	12.54	13.74	15.36	17.73	21.72
06	550.520.A3	00	07	1.46	8.65	10.60	12.24	13.68	14.99	16.75	19.35	23.69
065	550.530.A3	00	07	1.51	9.37	11.48	13.26	14.82	16.23	18.15	20.96	25.67
070	550.540.A3	00	07	1.58	10.09	12.36	14.28	15.96	17.48	19.55	22.57	27.64
074	550.550.A3	00	07	1.62	10.67	13.07	15.09	16.87	18.48	20.66	23.86	29.22
08	550.570.A3	00	07	1.69	11.54	14.13	16.31	18.24	19.98	22.34	25.80	31.59
087	550.580.A3	00	07	1.76	12.54	15.36	17.74	19.83	21.72	24.29	28.04	34.35
089	550.590.A3	00	07	1.78	12.83	15.72	18.15	20.29	22.23	24.85	28.69	35.14
10	550.600.A3	00	07	1.88	14.41	17.65	20.38	22.79	24.97	27.91	32.23	39.47
11	550.620.A3	00	07	1.97	15.86	19.42	22.42	25.07	27.46	30.70	35.45	43.42
124	550.640.A3	00	07	2.09	17.87	21.89	25.28	28.26	30.96	34.61	39.97	48.95
131	550.650.A3	00	07	2.15	18.89	23.13	26.71	29.86	32.71	36.57	42.23	51.72
139	550.660.A3	00	07	2.22	20.04	24.54	28.34	31.68	34.70	38.80	44.80	54.87
15	550.670.A3	00	07	2.30	21.62	26.48	30.58	34.19	37.45	41.87	48.35	59.22
165	550.690.A3	00	07	2.41	23.79	29.13	33.64	37.61	41.20	46.06	53.19	65.14
174	550.700.A3	00	07	2.48	25.08	30.72	35.47	39.66	43.45	48.57	56.09	68.69
183	550.710.A3	00	07	2.55	26.38	32.31	37.31	41.71	45.69	51.08	58.99	72.24
20	550.720.A3	00	07	2.66	28.83	35.31	40.78	45.59	49.94	55.84	64.47	78.96
218	550.740.A3	00	07	2.77	31.43	38.49	44.44	49.69	54.43	60.86	70.27	86.07
25	550.760.A3	00	07	2.96	36.04	44.14	50.97	56.99	62.43	69.80	80.60	98.71
294	550.790.A3	00	07	3.22	42.38	51.91	59.94	67.01	73.41	82.07	94.77	116.06
310	550.800.A3	00	07	3.30	44.69	54.73	63.20	70.66	77.40	86.54	99.93	122.39

Conversion formula for this series: $\dot{V}_2 = \dot{V}_1 \cdot \sqrt{\frac{p_2}{p_1}}$

Ordering Type + Code = Ordering no.
example: 550.300.A3 + 00 = 550.300.A3.00



Assembly accessories can be found in Chapter 9 "Accessories".



➤➤ AIR NOZZLES

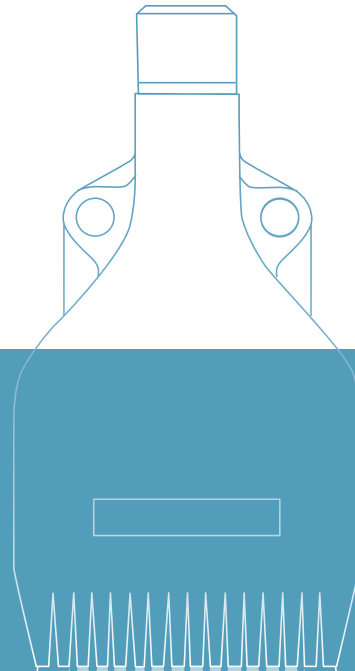

AIR NOZZLES

GENERAL INFORMATION

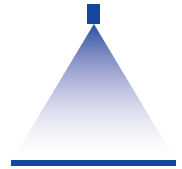

Compressed air is an indispensable tool in many areas for drying, cooling, cleaning, conveying, blowing off and much more. Lechler air nozzles make all this possible – with the highest level of precision at extraordinarily favourable conditions.

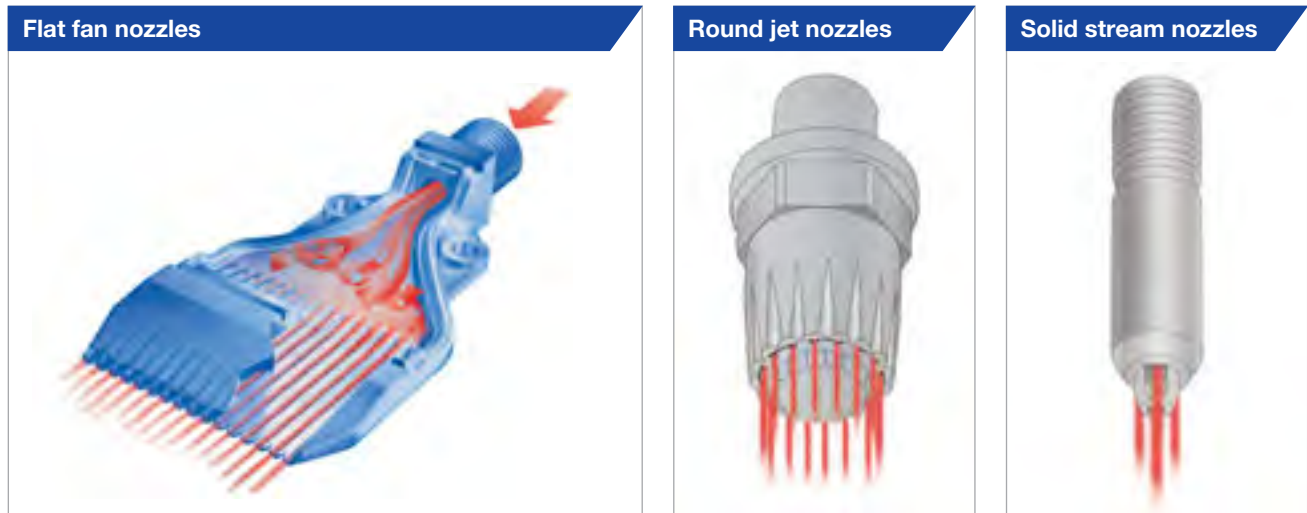

The three advantages of Lechler air nozzles for you

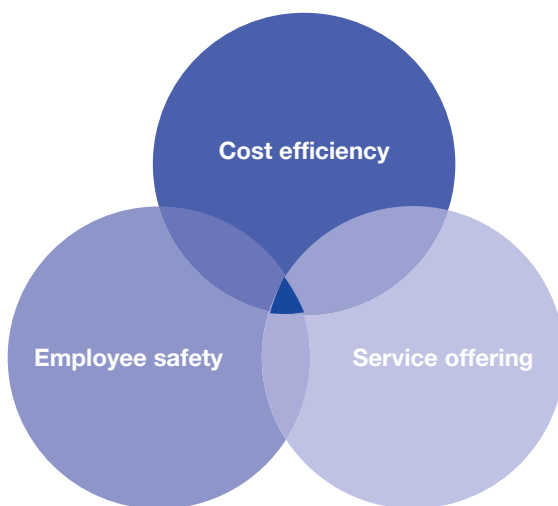

Cost efficiency

Lechler nozzles make it possible to reduce compressed air consumption by up to 45% compared to open pipes. In view of increasing energy costs and the growing range of compressed air applications, it is not surprising that there are extremely high potential savings in this area. An advantage that will have direct positive impact on your business.

Employee safety

The unique design of our nozzles allows noise levels to be verifiably reduced by up to 25% compared to conventional solutions – thus also reducing noise-related stress for your employees. Noise levels have been confirmed to reduce concentration resulting in increased levels of stress. The use of low-noise nozzles has a positive effect on production quality.

Service offering







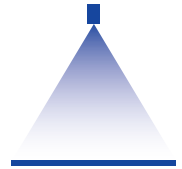

A perfect solution must be optimally tailored to the local requirements. We will, therefore, gladly advise you in person about the use of air nozzles and introduce you to new possibilities. Contact us and let us come up with the best possible solution together for improved quality and optimized process reliability.

Good to know

Detailed information can be found in our brochure "Air nozzles" as well as at www.lechler.com/de-en/airnozzles.

AIR NOZZLES OVERVIEW OF SERIES

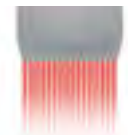























		Flat fan nozzles				
						
Series		600.130.56/S2	600.484.56	600.130.1Y	600.283.42	600.606.42
Information on page		164	165	166	167	167
Spray pattern		Multi-channel flat fan	Multi-channel flat fan	Multi-channel flat fan	Multi-channel flat fan	Multi-channel flat fan
						
Nozzle material	Plastic	•	•			
	Stainless steel			•		
	Brass					
	Zinc					
	Aluminum				•	•
Air consumption	At 2 bar	16 m ³ /h	8 m ³ /h	12 m ³ /h	18 m ³ /h	12 m ³ /h
Nozzle connection		1/4 BSPP 1/4 NPT	1/4 BSPP 1/4 NPT M12 x 1.25 Quick-release coupling size 5	1/4 BSPP 1/4 NPT	1/4 BSPP 1/4 NPT	1/4 BSPP 1/4 NPT
Maximum pressure		6 bar	6 bar	10 bar	10 bar	10 bar
Maximum temperature		PP natural: 60°C POM: 50°C	50°C	550°C	200°C	200°C
Noise level	At 2 bar	70 dB(A)	65 dB(A)	70 dB(A)	76 dB(A)	68.5 dB(A)
Blowing force	At 2 bar	2 N	0.8 N	2 N	2.4 N	1.4 N





Flat fan nozzles

		Flat fan nozzles			
					
Series		600.493.1Y	600.562.1Y	679	686
Information on page		168	169	170	172
Spray pattern					
Nozzle material	Plastic				
	Stainless steel	•	•	•	•
	Brass			•	•
	Zinc				
	Aluminum				
Air consumption	At 2 bar	30 m ³ /h	9 m ³ /h	3–31 m ³ /h	2–16 m ³ /h
Nozzle connection		1/4 BSPP 1/4 NPT	1/8 BSPP 1/8 NPT	Assembly with retaining nut 3/8 BSPP	1/8 BSPT
Maximum pressure		30 bar	30 bar	10 bar	30 bar
Maximum temperature		550°C	550°C	550°C (stainless steel) 240°C (brass)	550°C (stainless steel) 240°C (brass)
Noise level	At 2 bar	78 dB(A)	71 dB(A)	67–92 dB(A)	73–84 dB(A)
Blowing force	At 2 bar	4.2 N	1.2 N		

Round jet nozzles					Solid stream nozzle/Multiple solid stream nozzle	
						
600.326.5K	600.725.5K	600.326.3W	600.388.30	600.625.1Y	544	540/541
174	174	175	176	177	178	179
Multi-channel round jet	Multi-channel round jet	Multi-channel round jet	Multi-channel round jet	Multi-channel round jet	Solid stream	Multiple solid stream
						
•	•		•			
			•	•	•	•
		•				
15 m³/h	32 m³/h	15 m³/h	8 m³/h	2–4 m³/h	1-16 m³/h	34-251 m³/h
1/8 BSPP 1/4 BSPP 1/8 NPT 1/4 NPT M12 x 1.25	1/4 BSPP 1/4 NPT	1/4 BSPP 1/4 NPT M12 x 1.25	1/8 BSPP 1/8 NPT M12 x 1.25	M4 x 0.5 M5 x 0.5	1/8 BSPT 1/4 BSPT	1/2 BSPP
6 bar	6 bar	10 bar	10 bar	5 bar	30 bar	10 bar
50°C	50°C	90°C	50°C	550°C	550°C	550°C
74 dB(A)	96 dB(A)	79 dB(A)	77 dB(A)	63–70 dB(A)	65–90 dB(A)	
2.2 N	3.9 N	2.1 N	1.1 N	0.4–0.7 N	0.25–2.9 N	

Multi-channel flat fan nozzles for air “Whisperblast”, plastic version Series 600.130.56/S2

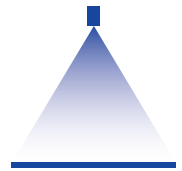

Features:

- Laminar, powerful air stream
- Low noise level
(also at higher levels of pressure)

Applications:

- Blowing off and out
- Cleaning
- Drying
- Cooling
- Transporting



Series 600.130.56/S2

OSHA^{®1}

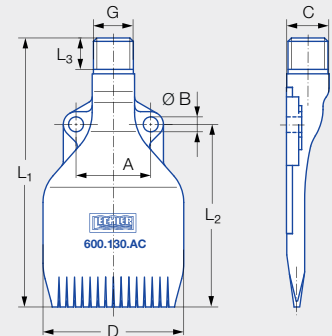

¹ Meets OSHA specifications in terms of noise level.

Cost savings and noise reduction



Cost savings

21%



Noise reduction

24%

Technical data

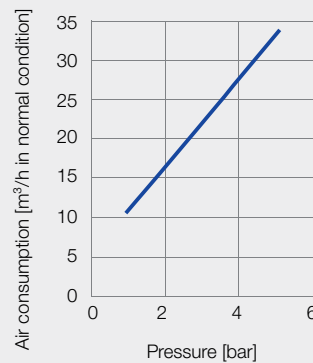
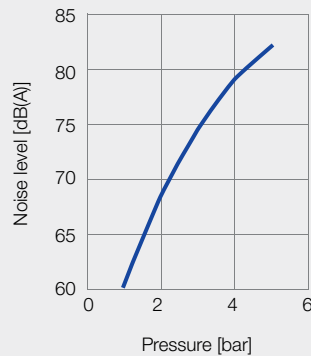
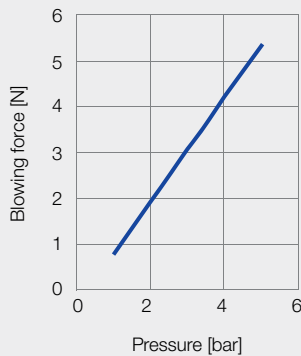

Code	G	Dimensions [mm]							Weight [g]
		A	C	D	L ₁	L ₂	L ₃	ØB	
AC	1/4 BSPP	25.0	14.2	47.0	90.0	61.0	10.5	5.0	20.0
BC	1/4 NPT	25.0	14.2	47.0	90.0	61.0	10.5	5.0	20.0

Ordering no.

Type	Mat. no.		Code	
	56	S2	1/4 BSPP	1/4 NPT
	POM	PP natural		
600.130	●	●	AC	BC

Ordering Type + Material no. + Code = Ordering no.
example: 600.130 + 56 + AC = 600.130.56.AC



Assembly accessories can be found in Chapter 9 “Accessories”.

Multi-channel flat fan nozzles for air "Whisperblast", plastic version Series 600.484.56

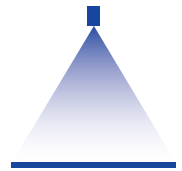

Features:

- Compact, powerful air stream
- Low noise level (also at higher levels of pressure)
- Narrow design

Applications:

- Blowing off and out
- Cleaning
- Drying
- Cooling
- Transporting



Series 600.484.56

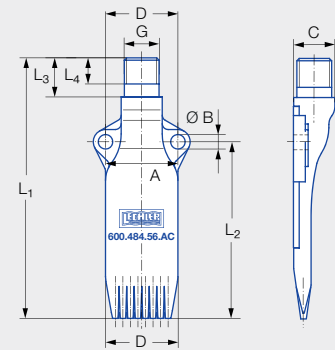

¹ Meets OSHA specifications in terms of noise level.

Cost savings and noise reduction



Cost savings

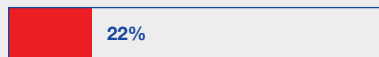

Noise reduction

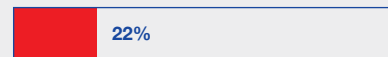

Technical data

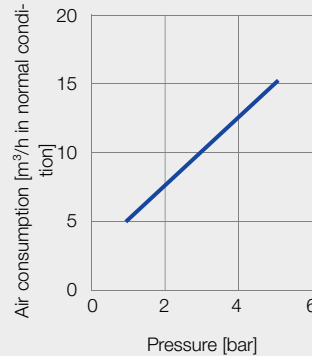
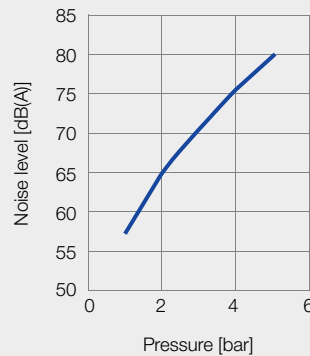
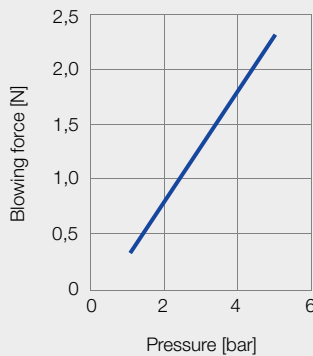

Code	G	Dimensions [mm]								Weight [g]
		A	C	D	L ₁	L ₂	L ₃	L ₄	Ø B	
AC	1/4 BSPP	25.0	14.2	25.0	90.0	61.0	13.5	9.0	5.0	16.0
BC	1/4 NPT	25.0	14.2	25.0	90.0	61.0	13.5	9.0	5.0	16.0
HG	M12 x 1.25	25.0	14.2	25.0	90.0	61.0	13.5	9.0	5.0	16.0
00	Quick-release coupling size 5	25.0	14.2	25.0	90.0	61.0	13.5	-	5.0	16.0

Ordering no.					
Type	Mat. no.	Code			
	56	1/4 BSPP	1/4 NPT	M12 x 1.25	Quick-release coupling size 5
POM					
600.484	●	AC	BC	HG	00

Ordering Type + Material no. + Code = Ordering no.
example: 600.484 + 56 + AC = 600.484.56.AC



Assembly accessories can be found in Chapter 9 "Accessories".

Multi-channel flat fan nozzles for air "Whisperblast", stainless steel version Series 600.130.1Y

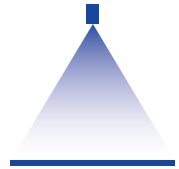

Features:

- Laminar, powerful air stream
- Low noise level (also at higher levels of pressure)
- For the highest demands

Applications:

- Blowing off and out
- Cleaning
- Drying
- Cooling
- Transporting



OSHA^{®1}

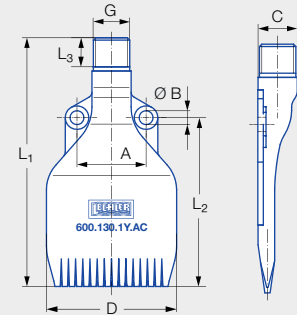

Series 600.130.1Y

¹ Meets OSHA specifications in terms of noise level.

Cost savings and noise reduction



Cost savings

24%



Noise reduction

22%

Technical data

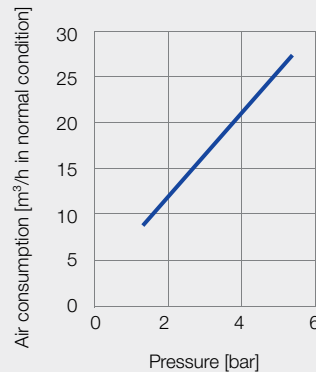
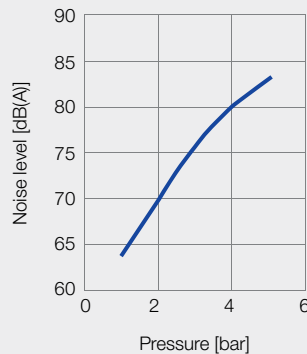
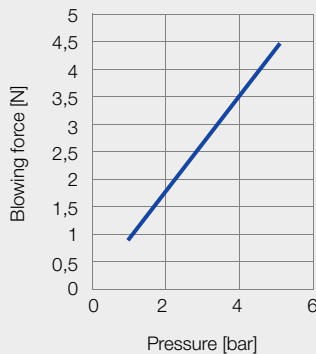

Code	G	Dimensions [mm]							Weight [g]
		A	C	D	L ₁	L ₂	L ₃	ØB	
AC	1/4 BSPP	22.0	13.0	42.0	81.0	53.0	10.5	4.0	100.0
BC	1/4 NPT	22.0	13.0	42.0	81.0	53.0	10.5	4.0	100.0

Ordering no.

Type	Mat. no.	Code	
	1Y	1/4 BSPP	1/4 NPT
	Stainless steel 316L		
600.130	●	AC	BC

Ordering Type + Material no. + Code = Ordering no.
example: 600.130 + 1Y + AC = 600.130.1Y.AC



Assembly accessories can be found in Chapter 9 "Accessories".

Multi-channel flat fan nozzles for air “Whisperblast”, metal version Series 600.283.42/600.606.42



Features:

- Laminar, powerful air stream
- High blowing force
- For high thermal and mechanical requirements

Applications:

- Blowing off and out
- Cleaning
- Drying
- Cooling
- Transporting

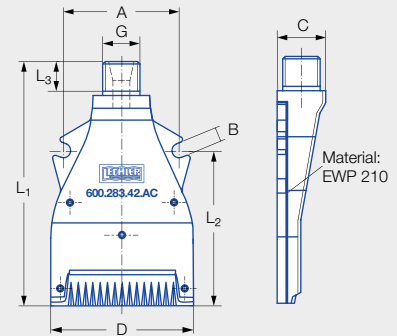

Series
600.283.42/600.606.42

¹ Meets OSHA specifications in terms of noise level.

Cost savings and noise reduction

Series 600.283/
Series 600.606



Cost savings

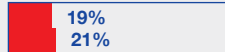

Noise reduction



Technical data

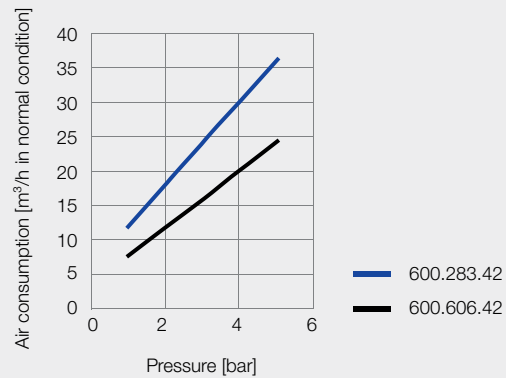
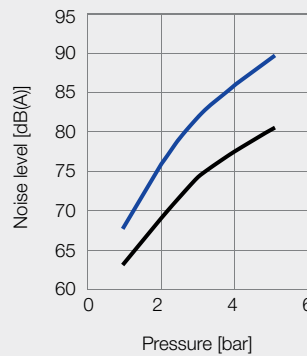
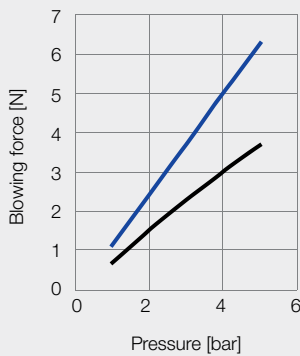

Code	G	Dimensions [mm]							Weight [g]
		A	B	C	D	L ₁	L ₂	L ₃	
AC	1/4 BSPP	41.0	5.1	17.0	51.0	86.5	55.0	10.5	60.0
BC	1/4 NPT	41.0	5.1	17.0	51.0	86.5	55.0	10.2	60.0

Ordering no.			
Type	Mat. no.	Code	
		42	1/4 BSPP
	Aluminum		
600.283	●	AC	BC
600.606	●	AC	

Ordering Type + Material no. + Code = Ordering no.
example: 600.283 + 42 + AC = 600.283.42.AC

Assembly accessories can be found in Chapter 9 “Accessories”.

Multi-channel flat fan nozzles for air "Whisperblast", stainless steel version Series 600.493.1Y

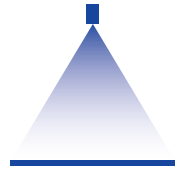

Features:

- Extremely wide, powerful air stream
- For the highest thermal requirements
- Protecting tips prevent air penetrating your skin

Applications:

- Blowing off and out
- Cleaning
- Drying



OSHA®

FDA

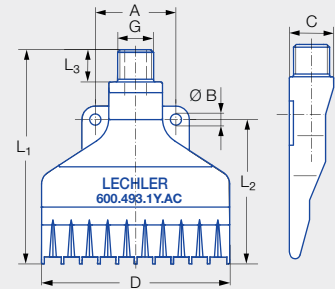

Series 600.493.1Y

Cost savings and noise reduction



Cost savings

34%



Noise reduction

21%

Technical data

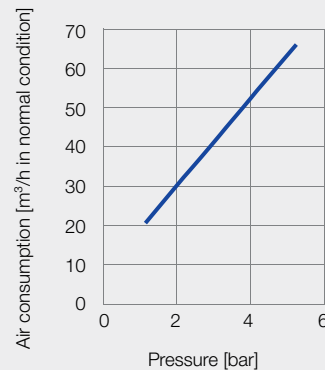
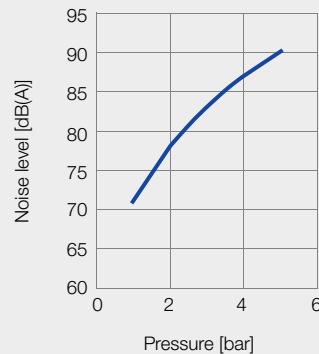
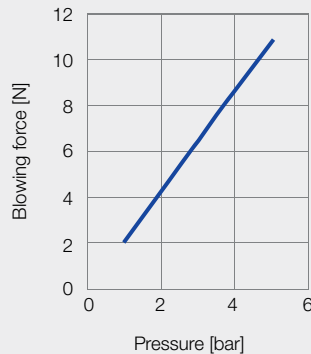

Code	G	Dimensions [mm]							Weight [g]
		A	C	D	L ₁	L ₂	L ₃	ØB	
AC	1/4 BSPP	30.0	16.5	70.0	79.7	53.7	12.0	4.2	130.0
BC	1/4 NPT	30.0	16.5	70.0	79.7	53.7	12.0	4.2	130.0

Ordering no.

Type	Mat. no.	Code	
	1Y	1/4 BSPP	1/4 NPT
	Stainless steel 316L		
600.493	●	AC	BC

Ordering Type + Material no. + Code = Ordering no.
example: 600.493 + 1Y + AC = 600.493.1Y.AC



Assembly accessories can be found in Chapter 9 "Accessories".

Multi-channel flat fan nozzles for air "Whisperblast", stainless steel version Series 600.562.1Y



Features:

- Compact, powerful air stream
- Angled design for applications with restricted installation conditions
- Resistant to higher pressures and temperatures
- Protecting tips prevent air penetrating your skin

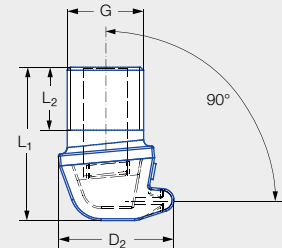
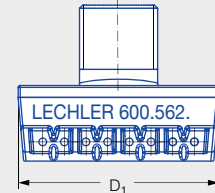

Applications:

- Blowing off and out
- Cleaning
- Drying

Series 600.562.1Y

Cost savings and noise reduction



Cost savings

8%



Noise reduction

14%

Technical data

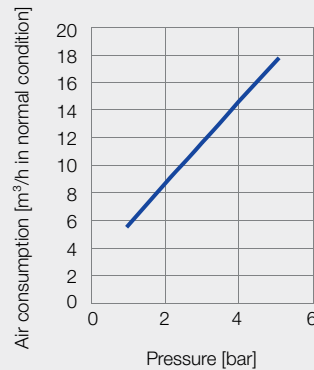
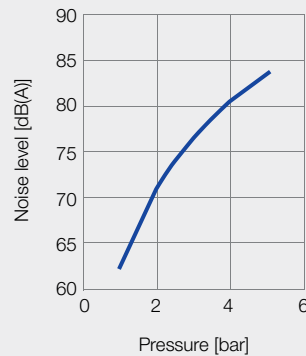
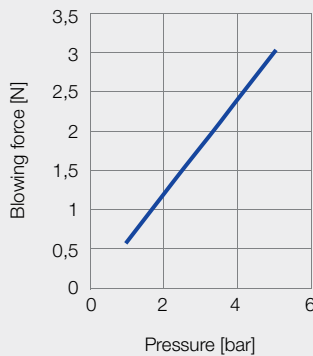

Code	G	Dimensions [mm]				Weight [g]
		D ₁	D ₂	L ₁	L ₂	
10	1/8 BSPP	25.0	14.7	19.5	8.0	17.0
20	1/8 NPT	25.0	14.7	19.5	6.7	17.0

Ordering no.			
Type	Mat. no.	Code	
	1Y	1/8 BSPP	1/8 NPT
	Stainless steel 316L		
600.562	●	10	20

Ordering Type + Material no. + Code = Ordering no.
example: 600.562 + 1Y + 10 = 600.562.1Y.10



Assembly accessories can be found in Chapter 9 "Accessories".

Flat fan nozzles for air or saturated steam Series 679

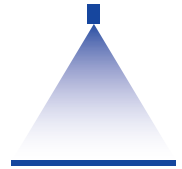

Features:

- Wide, powerful air stream
- Assembly with retaining nut
- Easy nozzle changing
- Simple jet alignment

Applications:

- Blowing off liquids
- Cooling
- Heating
- Drying



OSHA¹

FDA²

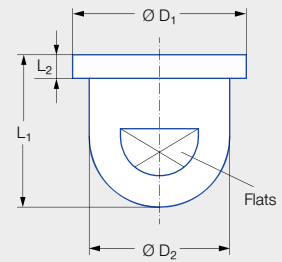

Series 679

¹ Meets OSHA specifications in terms of noise level.

² Only applies to the stainless variant.

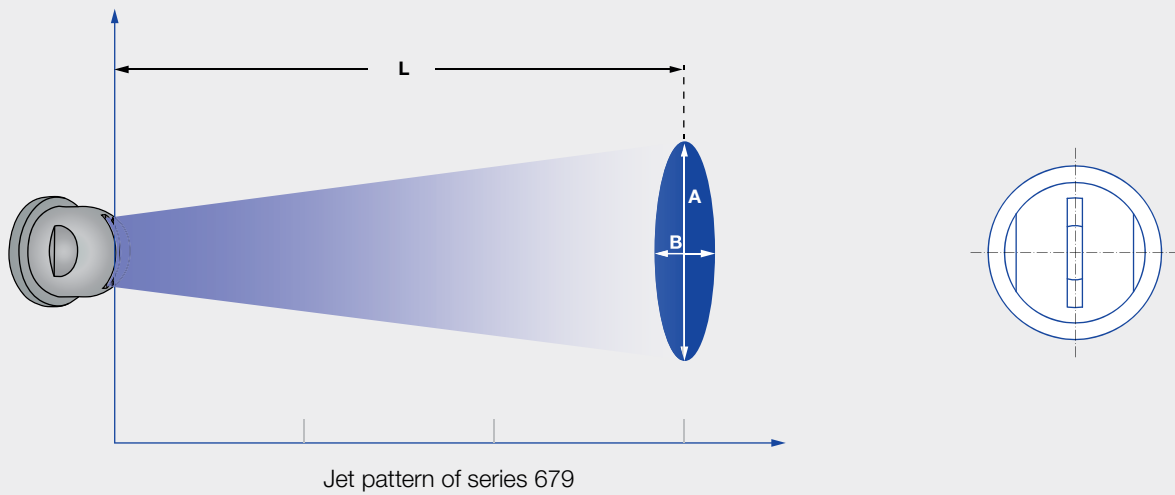

Pressure		1 bar	3 bar	5 bar
679.037	Length L [mm]	50	100	150
	A [mm]	110	260	380
	B [mm]	25	35	45
679.117	Length L [mm]	50	125	150
	A [mm]	100	250	310
	B [mm]	25	30	35
679.255	Length L [mm]	375	500	500
	A [mm]	90	190	280
	B [mm]	90	90	90

Pressure		1 bar	3 bar	5 bar
679.415	Length L [mm]	675	900	900
	A [mm]	160	300	460
	B [mm]	215	215	215
679.495	Length L [mm]	900	900	900
	A [mm]	200	425	510
	B [mm]	230	230	230

Code	Dimensions [mm]					Weight [g] (brass)
	L ₁	L ₂	Ø D ₁	Ø D ₂	Flats	
Assembly with retaining nut 3/8 BSPP	13.0	2.0	14.8	12.0	10	8.0

Spray angle	Ordering no.			Equivalent bore diameter B [mm]	V _n air [m ³ /h]				M saturated steam [kg/h]			
	Type	Mat. no.			p [bar]				p [bar]			
		17	30									
		Stainless steel 316Ti	Brass		0.5	2.0	5.0	10.0	0.5	2.0	5.0	10.0
Approx. 70°–90°	679.037		●	1.2	1.5	3.0	6.0	11.0	1.2	2.3	4.6	8.3
	679.085	●	●	1.3	2.0	4.0	8.0	14.7	1.6	3.1	6.1	11.1
	679.117	●	●	1.5	2.1	4.2	8.4	15.4	1.7	3.3	6.5	11.7
	679.165	●	●	1.8	2.6	5.1	10.3	18.8	2.0	4.1	8.0	14.3
	679.255	●	●	2.1	3.6	7.3	14.5	26.6	2.8	5.7	11.2	20.2
	679.365	●	●	2.8	6.3	12.7	25.4	46.5	5.0	10.0	19.6	35.3
	679.415	●	●	3.6	10.2	20.3	40.7	74.6	8.0	16.0	31.4	56.7
	679.495	●	●	4.3	15.6	31.1	62.2	114.0	12.4	24.8	48.5	87.6

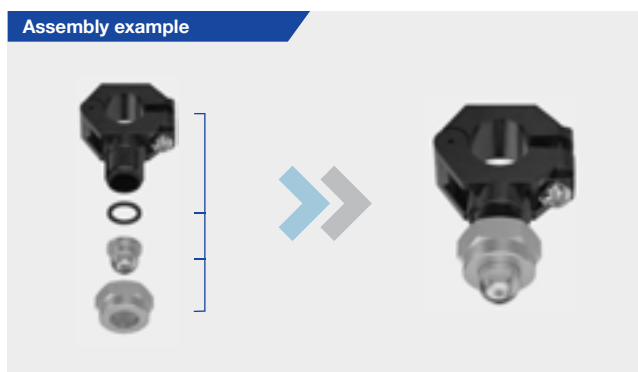

Ordering Type + Material no. = Ordering no.
 example: 679.037 + 30 = 679.037.30



Assembly accessories can be found in Chapter 9 "Accessories".

Flat fan tongue-type nozzles for air or saturated steam

Series 686

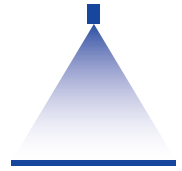

Features:

- Wide, powerful air stream
- Compact design
- Large spray width, also for short blowing distances
- Brass and stainless steel versions available for high ambient temperatures



OSHA¹

FDA²

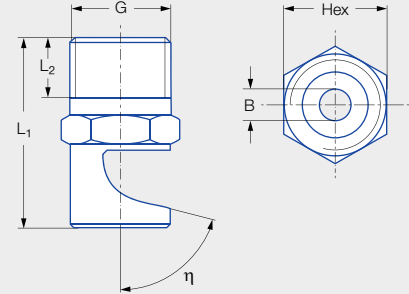

Applications:

- Blowing off liquids
- Cooling
- Heating
- Drying

Series 686

¹ Meets OSHA specifications in terms of noise level.

² Only applies to the stainless variant.

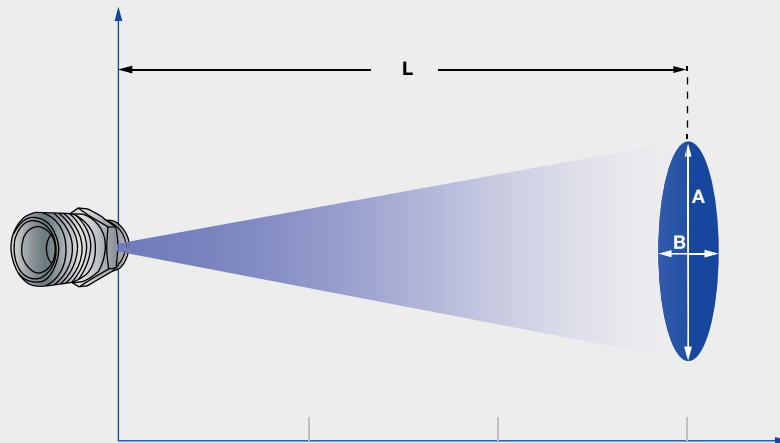

Jet pattern of series 686

Pressure		1 bar	3 bar	5 bar
686.408	Length L [mm]	40	80	125
	A [mm]	35	50	60
	B [mm]	15	40	50
686.528	Length L [mm]	60	100	150
	A [mm]	75	140	210
	B [mm]	20	40	50
686.608	Length L [mm]	90	175	250
	A [mm]	145	230	350
	B [mm]	25	45	55

Pressure		1 bar	3 bar	5 bar
686.688	Length L [mm]	150	400	525
	A [mm]	230	560	740
	B [mm]	40	80	100
686.728	Length L [mm]	180	230	375
	A [mm]	170	360	530
	B [mm]	50	50	70

G	Dimensions [mm]			Weight [g] (brass)
	L ₁	L ₂	Hex	
1/8 BSPT	23.0	6.5	11	18.0

Spray angle	η	Ordering no.				Bore diameter B [mm]	\dot{V}_n air [m ³ /h]				\dot{M} saturated steam [kg/h]			
		Mat. no.		Code	p [bar]				p [bar]					
		16	30											
		Type	Stainless steel 303	Brass	1/8 BSPT									
Approx. 27°–47°	75°	686.408	●	●	CA	1.00	1.07	1.60	3.20	5.86	0.88	1.31	2.57	4.64
	75°	686.488	●	●	CA	1.30	1.76	2.64	5.29	9.69	1.46	2.17	4.25	7.67
Approx. 70°	75°	686.528	●	●	CA	1.50	2.2	3.31	6.61	12.13	1.83	2.71	5.31	9.59
	75°	686.568	●	●	CA	1.70	2.73	4.09	8.19	15.01	2.27	3.36	6.57	11.87
	75°	686.608	●	●	CA	1.90	3.35	5.02	10.04	18.40	2.78	4.11	8.06	14.55
	75°	686.688	●	●	CA	2.40	5.45	8.18	16.36	30.00	4.53	6.71	13.14	23.72
	75°	686.728	●	●	CA	2.70	6.88	10.33	20.65	37.86	5.71	8.46	16.58	29.94
	75°	686.808	●	●	CA	3.40	10.89	16.33	32.66	59.87	9.04	13.28	26.22	47.35

Ordering Type + Material no. + Code = Ordering no.
 example: 686.408 + 16 + CA = 686.408.16.CA



Assembly accessories can be found in Chapter 9 "Accessories".

Multi-channel round jet nozzles for air, plastic version

Series 600.326.5K/600.725.5K

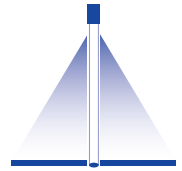

Features:

- Powerful, circular air stream
- Low noise level
- Reduced air consumption

Applications:

- Targeted blowing off and blowing out (e.g. in connection with a compressed air gun)



OSHA®

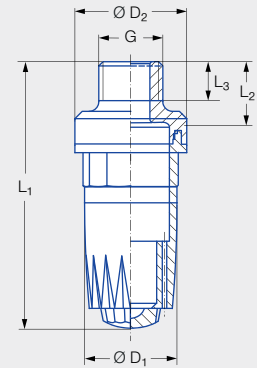

Series
600.326.5K/600.725.5K

Cost savings and noise reduction



Cost savings

9%



Noise reduction

17%

Technical data

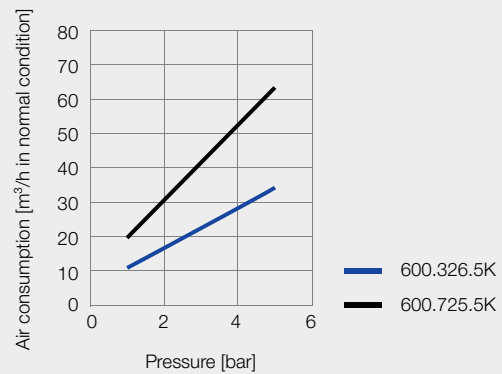
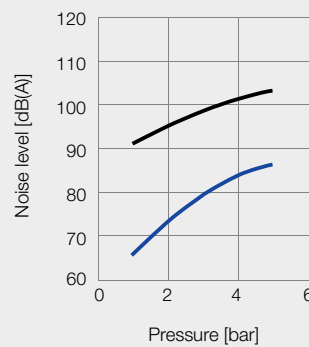
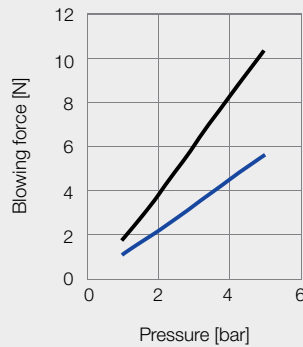

Code	G	Dimensions [mm]					Weight [g]
		L ₁	L ₂	L ₃	Ø D ₁	Ø D ₂	
AA	1/8 BSPP	54.0	9.5	6.2	19.0	23.0	7.0
AC	1/4 BSPP	55.0	10.2	8.0	19.0	23.0	7.0
BA	1/8 NPT	54.0	9.5	6.7	19.0	23.0	7.0
BC	1/4 NPT	55.0	10.2	9.7	19.0	23.0	7.0
HG	M12 x 1.25	55.0	10.2	8.0	19.0	23.0	7.0

Ordering no.						
Type	Mat. no.	Code				
	ABS	1/8 BSPP	1/4 BSPP	1/8 NPT	1/4 NPT	M12 x 1.25
600.326.5K	●	AA	AC	BA	BC	HG
600.725.5K	●		AC		BC	

Ordering Type + Code = Ordering no.
example: 600.326.5K + AA = 600.326.5K.AA



Assembly accessories can be found in Chapter 9 "Accessories".

Multi-channel round jet nozzles for air, zinc version

Series 600.326.3W

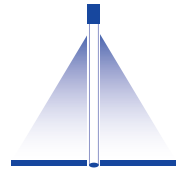

Features:

- Powerful, circular air stream
- Low noise level
- Reduced air consumption
- Zinc version: Use at high pressure and temperature levels

Applications:

- Targeted blowing off and blowing out (e.g. in connection with a compressed air gun)



OSHA®

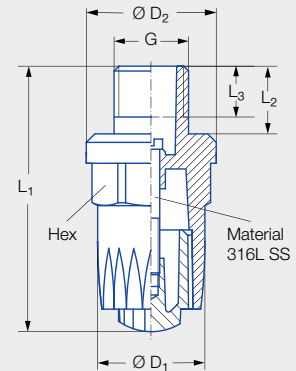

Series 600.326.3W

Cost savings and noise reduction



Cost savings

8%



Noise reduction

17%

Technical data

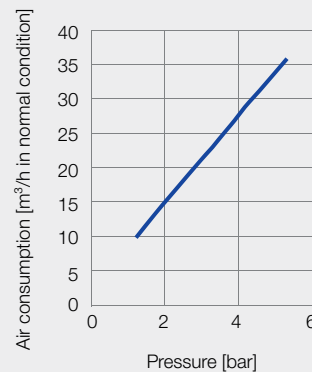
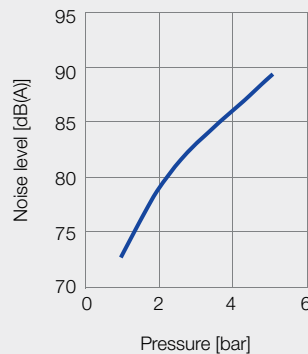
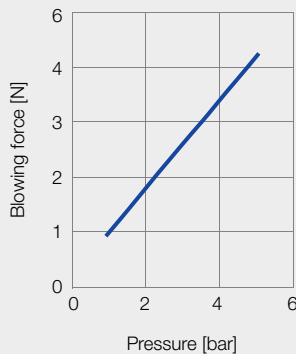

Code	G	Dimensions [mm]						Weight [g]
		L ₁	L ₂	L ₃	Ø D ₁	Ø D ₂	Hex	
AC	1/4 BSPP	47.0	12.0	9.0	19.0	23.0	19	50.0
BC	1/4 NPT	47.0	12.0	10.2	19.0	23.0	19	50.0
HG	M12 x 1.25	47.0	12.0	9.5	19.0	23.0	19	50.0

Ordering no.

Type	Mat. no.	Code		
	Zinc	1/4 BSPP	1/4 NPT	M12 x 1.25
600.326.3W	●	AC	BC	HG

Ordering Type + Code = Ordering no.
 example: 600.326.3W + AC = 600.326.3W.AC



Assembly accessories can be found in Chapter 9 "Accessories".

Mini multi-channel round jet nozzles for air

Series 600.388.30

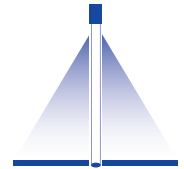

Features:

- Powerful, punctiform air stream for large distances
- Compact design
- Low noise level
- Reduced air consumption
- Particularly suitable for difficult-to-reach locations

Applications:

- Targeted blowing off and blowing out (e.g. in connection with a compressed air gun)

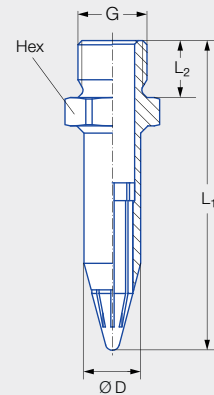

Series 600.388.30

Cost savings and noise reduction



Cost savings

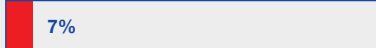

Noise reduction

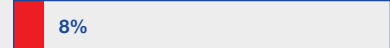

Technical data

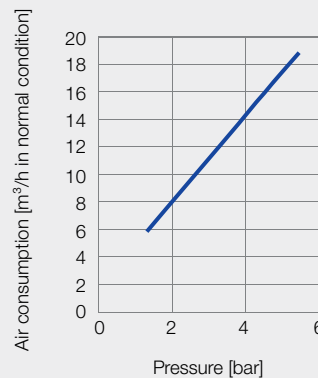
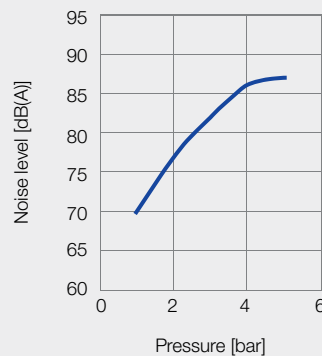
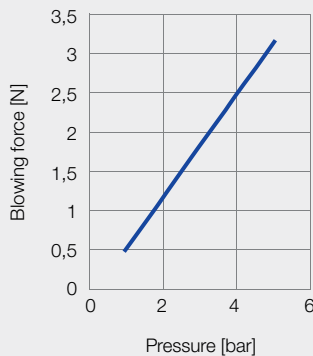

Code	G	Dimensions [mm]				Weight [g]
		L ₁	L ₂	Ø D	Hex	
AA	1/8 BSPP	43.5	8.0	8.0	12	12.0
BA	1/8 NPT	44.0	6.7	8.0	12	12.0
HG	M12 x 1.25	43.5	8.0	8.0	17	20.0

Ordering no.				
Type	Mat. no.	Code		
	Brass, POM	1/8 BSPP	1/8 NPT	M12 x 1.25
600.388.30	●	AA	BA	HG

Ordering Type + Code = Ordering no.
example: 600.388.30 + AA = 600.388.30.AA

Assembly accessories can be found in Chapter 9 "Accessories".

Micro multi-channel round jet nozzles for air

Series 600.625.1Y

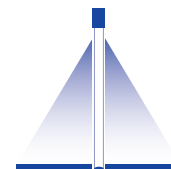

Features:

- Powerful, punctiform air stream
- Ultra-compact design for difficult-to-reach locations
- Low noise level
- Reduced air consumption
- For the highest thermal requirements



OSHA®

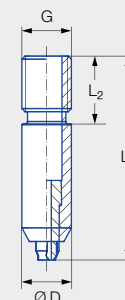

Applications:

- Targeted blowing off and blowing out

Series 600.625.1Y

Cost savings and noise reduction



Cost savings

10%



Noise reduction

6%

Technical data

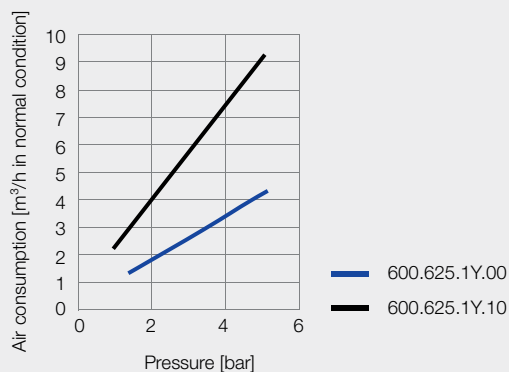
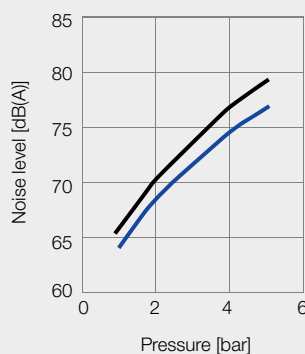
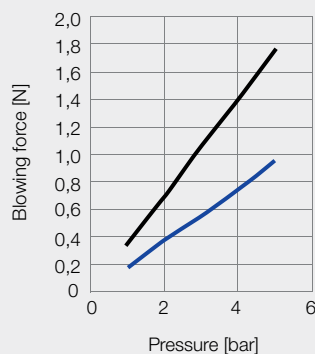

Code	G	Dimensions [mm]			Weight [g]
		L ₁	L ₂	Ø D	
00	M4 x 0.5	16.5	5.5	4.0	1.0
10	M5 x 0.5	16.5	5.5	5.0	1.0

Ordering no.			
Type	Mat. no.	Code	
	1Y	M4 x 0.5	M5 x 0.5
Stainless steel 316L			
600.625	●	00	10

Ordering Type + Material no. + Code = Ordering no.
 example: 600.625 + 1Y + 00 = 600.625.1Y.00



Assembly accessories can be found in Chapter 9 "Accessories".

➤ Solid stream nozzles for air or saturated steam

Series 544

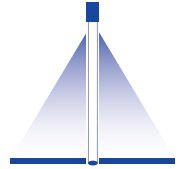

Features:

- Powerful, punctiform air stream
- Stainless steel version for higher ambient temperatures

Applications:

- Targeted blowing off and blowing out



OSHA^{®1}

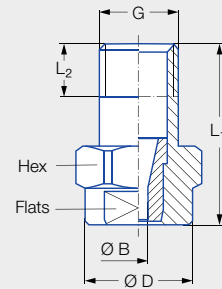

Series 544

¹ Meets OSHA specifications in terms of noise level.

Code	G	Dimensions [mm]					Weight [g]
		L ₁	L ₂	Ø D	Hex	Flats	
CA	1/8 BSPT	22.0	6.5	13.0	14	10	14.0
CC	1/4 BSPT	22.0	10.0	13.0	14	10	16.0

Ordering no.				Bore diameter B [mm]	V̇ _n air [m ³ /h]				Ṁ saturated steam [kg/h]			
Type	Mat. no.	Code			p [bar]				p [bar]			
	16	1/8 BSPT	1/4 BSPT		1.0	2.0	3.0	5.0	1.0	2.0	3.0	5.0
	Stainless steel 303											
544.360	●	CA	CC	1.05	0.93	1.40	1.92	2.88	0.77	1.14	1.64	2.42
544.400	●	CA	CC	1.30	1.43	2.14	2.94	4.41	1.18	1.75	2.51	3.71
544.480	●	CA	CC	1.33	1.67	2.51	3.42	5.13	1.39	2.06	2.92	4.23
544.560	●	CA	CC	1.69	2.58	3.87	5.27	7.90	2.14	3.18	4.50	6.66
544.640	●	CA	CC	2.09	4.33	6.50	8.81	13.22	3.60	5.33	7.52	11.13
544.720	●	CA	CC	2.66	6.85	10.27	14.00	21.02	5.68	8.42	11.96	17.70
544.800	●	CA	CC	3.30	10.75	16.12	21.87	32.81	8.92	13.21	18.66	27.63

Ordering Type + Material no. + Code = Ordering no.
 example: 544.360 + 16 + CA = 544.360.16.CA

 Assembly accessories can be found in Chapter 9 "Accessories".

Cluster solid stream nozzles for air or saturated steam

Series 540/541



Features:

- Powerful round jet through 40 individual bore holes
- Delivery of media at an angle of approx. 240°
- Suitable for use in difficult conditions
- Suitable for immersion in liquid media

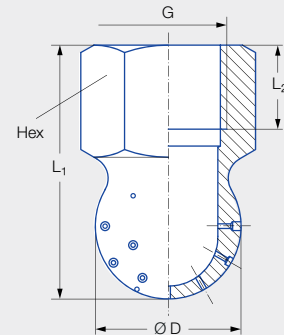

Applications:

- Injection of steam into liquids
- Injection of compressed air into bulk goods
- Injection of gas (acid and neutralization baths)

Series 540/541

G	Dimensions [mm]				Weight [g]
	L ₁	L ₂	Ø D	Hex	
1/2 BSPP	45.0	15.0	26.0	27	100.0

Spray angle	Ordering no.		Bore diameter B [mm]	V̇ _n air [m³/h]				M saturated steam [kg/h]					
	Type	Mat. no.		p [bar]				p [bar]					
		16		1.0	2.0	3.0	5.0	1.0	2.0	3.0	5.0		
		Stainless steel 303											
Approx. 240°	540.909	●	0.80	22.80	34.20	45.50	68.30	18.10	26.90	35.50	52.70		
	540.989	●	1.00	35.50	53.30	71.00	106.50	28.20	41.70	55.10	81.70		
	541.109	●	1.50	83.30	124.90	166.50	249.80	66.00	97.70	129.20	191.60		
	541.189	●	2.00	129.70	194.50	259.30	389.00	103.00	152.60	201.70	299.10		
	541.239	●	2.30	167.20	250.80	334.30	501.50	133.20	197.30	260.80	386.60		

Ordering Type + Material no. = Ordering no.
 example: 540.909 + 16 = 540.909.16

Assembly accessories can be found in Chapter 9 "Accessories".



➤➤ TANK CLEANING NOZZLES



TANK CLEANING NOZZLES GENERAL INFORMATION



Static

Static spray balls do not rotate and therefore require considerably more liquid for cleaning processes. They are used primarily for rinsing tanks. Spray balls are a very robust and cost effective solution used in many processes.



Free-spinning

Free spinning devices utilize spray nozzles that are engineered in a specific position to allow the fluid to drive/rotate the spray head. The repeated impacts of the spray remove the soil and rinse it from the tank surface. This results in optimum cleaning efficiency at low pressures in small to medium-sized tanks.



Controlled rotation

The rotating head is driven by the fluid. A turbine wheel with an internal gear is used to control the rotation. This ensures that the speed remains in the optimum range even at higher pressures. The generated droplets are larger and impact the tank wall at higher speed. These rotating cleaning nozzles thus achieve an even higher impact which is especially important for large tanks.



Gear-controlled

The cleaning fluid drives an internal gear by means of a turbine wheel so that the spray head rotates around two axes. The solid jet nozzles mounted on the spray head produces powerful solid stream like jets. These solid jets sweep the entire tank surface in a pre-programmed, model-specific pattern during a spray cycle. This requires a certain minimum time. These models generate the highest impact and are ideal for very large tanks and the toughest cleaning tasks.

Materials



Lechler tank cleaning nozzles are made of high quality materials such as Stainless steel 316L, PVDF, PEEK or PTFE. In addition to the requirements for material resistance and wear, the materials must also be food grade for use in the beverage, food and pharmaceutical industries.

A large number of the materials used for Lechler tank cleaning nozzles comply with the requirements of the FDA or conform to regulation (EC) 1935/2004.

Hygienic requirements



All Lechler precision nozzles for tank cleaning are designed to meet hygiene requirements. In addition, Lechler also offers special nozzles for particularly stringent hygienic applications, certified to 3-A.

ATEX



Lechler offers several nozzle series designed especially for use in explosive atmospheres.

The respective logo on the product pages indicates which requirements are met.

Good to know

Detailed information can be found in our brochure "Tank and Equipment Cleaning" as well as at www.lechler.com/de-en/tankcleaningnozzles.

Cleaning efficiency classes 1 to 5



Cleaning efficiency classes

Lechler precision nozzles for tank and equipment cleaning are divided into five different cleaning efficiency classes. This is intended to help users find the right nozzle for the respective application quickly.

Every nozzle from Lechler is assigned to a class. The respective class is suitable for specific cleaning tasks.

Dependant upon the application, several cleaning classes can be suitable to the task of removing soils from your application. Generally, it is not possible to quantify and/or differentiate between soil types. The information should be seen as a guide intended to make it easier in the selection to finding the right nozzle.

The first step is to find a cleaning efficiency class suitable for the task. If your application is to clean a non-adhering pow-

der material from a tank surface the cleaning task can be defined as "rinsing". The nozzle series in cleaning efficiency class 1, e.g. static spray ball, or class 2, e.g. MicroWhirly or MiniSpinner, would be suitable for rinsing/washing cycle.

Taking into account the maximum possible tank diameter and the flow rate range, the tables on the following pages can be used to quickly narrow down the suitable nozzles. If the focus is on a low purchase price in the above referenced example, a spray ball should be chosen. If you want to save on your cost-intensive cleaning media, the MicroWhirly or MiniSpinner would be recommended.

If there is no recommended series for the tank diameter, several nozzles can be positioned in the tank to ensure that the distance between nozzle and tank is within the required dimensions.

Simulation software

Various inserts, such as agitators or mixing blades, can cause spray shadows. To find the ideal nozzle for such complex challenges, we have developed TankClean. The software simulates the use of various tank cleaning nozzles. The tank geometry is freely definable. As a result, subsequent cleaning can already be optimized in the planning phase.

TankClean









Function video
www.lechler.com/tankclean







Or scan the QR code.

TANK CLEANING NOZZLES OVERVIEW OF SERIES











		Cleaning efficiency class 1				
						
Series		540/541	5B2/5B3	500.234	566	500.186
Information on page		188	189	191	192	194
Type		Static spray ball	Static spray ball	Rotating cleaning nozzle	Rotating cleaning nozzle	Rotating cleaning nozzle
Operating principle	Static	•	•			
	Free-spinning			•	•	•
	Controlled rotation					
	Gear-controlled					
Max. tank diameter	Very small (up to ≈ 1 m)	•	•	•	•	•
	Small (up to ≈ 2 m)	•	•		•	
	Medium (up to ≈ 3 m)	•	•			
	Large (up to ≈ 8 m)	•	•			
	Very large (> 8 m)	•				
Flow rate	Very low (up to ≈ 25 l/min)	•	•	•	•	•
	Low (up to ≈ 50 l/min)	•	•			
	Medium (up to ≈ 100 l/min)	•	•			
	High (up to ≈ 400 l/min)		•			
	Very high (up to ≈ 700 l/min)		•			
Nozzle material	Stainless steel	•	•	•	•	
	Plastic					•
Nozzle connection	Thread	•		•	•	•
	Slip-on connection		•			
	Tri-Clamp					
ATEX available					•	





Cleaning efficiency class 2

						
500.191	5M1	5M2	5M3	5M4	573/583	5P2/5P3
195	196	198	200	202	204	206
Rotating cleaning nozzle	Rotating cleaning nozzle	Rotating cleaning nozzle	Rotating cleaning nozzle	Rotating cleaning nozzle	Rotating cleaning nozzle	Rotating cleaning nozzle
•	•	•	•	•	•	•
•	•	•	•	•	•	•
		•	•	•	•	•
			•	•	•	
				•		
•	•	•				•
		•	•		•	•
			•	•	•	
				•		
	•	•	•	•		•
•					•	
•	•	•	•	•	•	
		•	•	•	•	
						•
	•	•	•	•		•





		Cleaning efficiency class 3		
				
Series		594/595	5W9	577
Information on page		208	210	212
Type		Rotating cleaning nozzle	Rotating cleaning nozzle	Rotating cleaning nozzle
Operating principle	Static			
	Free-spinning	•	•	•
	Controlled rotation			
	Gear-controlled			
 Max. tank diameter	Very small (up to ≈ 1 m)	•	•	
	Small (up to ≈ 2 m)	•	•	•
	Medium (up to ≈ 3 m)	•	•	•
	Large (up to ≈ 8 m)			•
	Very large (> 8 m)			
 Flow rate	Very low (up to ≈ 25 l/min)	•		
	Low (up to ≈ 50 l/min)	•	•	
	Medium (up to ≈ 100 l/min)	•	•	
	High (up to ≈ 400 l/min)			•
	Very high (up to ≈ 700 l/min)			•
 Nozzle material	Stainless steel	•	•	•
	Plastic			
 Nozzle connection	Thread	•	•	•
	Slip-on connection	•	•	
	Tri-Clamp			
ATEX available			•	

Cleaning efficiency class 4		Cleaning efficiency class 5		
				
5S2/5S3	5S5	5TA	5TB	5TM
213	215	217	219	220
Rotating cleaning nozzle	Rotating cleaning nozzle	High impact cleaner	High impact cleaner	High impact cleaner
•	•			
		•	•	•
•	•	•	•	•
•	•	•	•	•
•	•	•	•	•
	•	•	•	•
•		•		
•	•	•	•	•
•	•		•	•
•	•	•	•	•
•	•	•	•	•
•	•			
•		•	•	

Static spray balls

Series 540/541

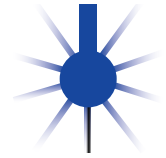

Features:

- Robust and particularly compact design
- Threaded connection
- Suitable for very high temperatures
- Also suitable for operation with steam and air

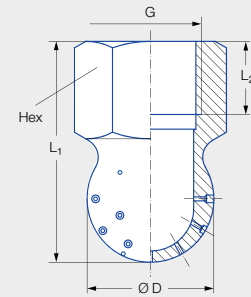

Series 540/541

Female thread

Max. tank diameter [m]	0	1	2	3	4	5	6	7	8	9
------------------------	---	---	---	---	---	---	---	---	---	---



Cleaning efficiency class
1



Max. temperature
200°C



Installation
Operation in every direction is possible



Material
Stainless steel 303



Recommended operating pressure
3 bar

Spray angle	Ordering no.	Narrowest free cross section Ø [mm]	V̇ water [l/min]						Max. tank diameter [m]
			p [bar] (p _{max} = 10 bar)						
			0.5	1.0	2.0	3.0	5.0	at 40 psi [US gal/min]	
240° 	540.909.16	0.8	9	13	18	22	28	6	6.5
	540.989.16	1.0	14	20	28	34	44	9	7.0
	541.109.16	1.5	29	40	57	70	90	18	7.5
	541.189.16	2.0	45	64	90	110	142	28	8.3
	541.239.16	2.3	59	83	118	145	187	37	9.5

NPT thread available on request.

The maximum tank diameter applies to the recommended operating pressure and is meant as a recommendation only. The cleaning result is also affected by the type of soiling.

Static spray balls RinseClean Series 5B2/5B3

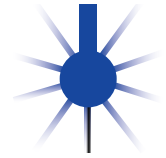

Features:

- No moving parts
- Self-draining
- Proven use in many applications
- Suitable for very high temperatures and hygienic requirements

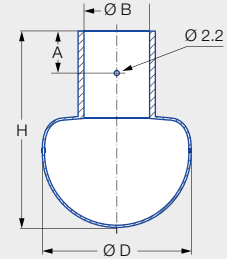

Series 5B2/5B3

Dimension of the slip-on connection according to DIN 10357, Series B

With the slip-on connection, the spray ball is pushed onto the customer's connection pipe and secured with the supplied Pin.



Pin 1

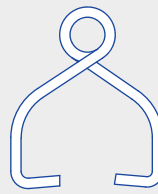

Pin 2-5

Max. tank diameter [m]	0	1	2	3	4	5	6	7	8	9
------------------------	---	---	---	---	---	---	---	---	---	---



Cleaning efficiency class
1



Max. temperature
200°C



Installation
Operation in every direction is possible



Material
Stainless steel 316L,
pin stainless steel 316L





Recommended operating pressure
2 bar

Function video
www.lechler.com/staticsprayball
Or scan the QR code.





Spray angle	Ordering no.	Narrowest free cross section Ø [mm]	V̇ water [l/min]					Dimensions [mm]				Pin	Max. tank diameter [m]
	Type		p [bar] (p _{max} = 5 bar)					Distance to bore A	Connection B	Height H	Ø D		
			0.5	1.0	2.0	3.0	at 40 psi [US gal/min]						
180° 	5B3.083.1Y.D1.80	1.2	25	35	50	61	16	9.0	18.2	42.0	28.0	1	2.2
	5B3.253.1Y.D2.20	1.8	65	92	130	159	40	18.0	22.2	84.0	64.0	2	3.0
	5B3.323.1Y.D2.80	2.3	100	141	200	245	62	18.0	28.2	84.0	64.0	3	3.5
	5B3.463.1Y.D5.20	3.3	230	325	460	563	143	25.0	52.3	111.0	90.0	5	5.4
180° 	5B3.114.1Y.D1.80	1.4	30	42	60	74	19	9.0	18.2	42.0	28.0	1	2.2
	5B3.274.1Y.D2.20	2.3	75	106	150	184	47	18.0	22.2	84.0	64.0	2	3.0
	5B3.394.1Y.D2.80	3.0	145	205	290	355	90	18.0	28.2	84.0	64.0	3	5.0
	5B3.444.1Y.D5.20	3.2	200	283	400	490	124	25.0	52.3	111.0	90.0	5	5.2
360° 	5B2.879.1Y.D0.80	0.8	8	11	15	18	5	9.0	8.2	37.0	20.0	1	2.0
	5B3.089.1Y.D1.20	1.0	25	35	50	61	16	9.0	12.2	42.0	28.0	1	2.2
	5B3.139.1Y.D1.20	1.6	33	46	65	80	20	9.0	12.2	42.0	28.0	1	2.3
	5B3.209.1Y.D1.80	1.5	50	71	100	123	31	9.0	18.2	42.0	28.0	1	2.5
	5B3.309.1Y.D2.20	1.7	90	127	180	221	56	18.0	22.2	84.0	64.0	2	3.5
	5B3.379.1Y.D2.80	2.1	130	184	260	318	81	18.0	28.2	84.0	64.0	3	5.2
	5B3.389.1Y.D4.00	2.1	140	198	280	343	87	18.0	40.3	84.0	64.0	4	5.2
	5B3.409.1Y.D3.40	2.3	160	226	320	392	99	18.0	34.2	84.0	64.0	4	5.2
	5B3.449.1Y.D2.80	3.0	205	290	410	502	127	18.0	28.2	84.0	64.0	3	5.4
	5B3.489.1Y.D3.40	2.9	255	361	510	625	158	18.0	34.2	84.0	64.0	4	5.5
5B3.499.1Y.D4.00	2.8	270	382	540	661	168	18.0	40.3	84.0	64.0	4	5.5	
	5B3.539.1Y.D5.20	3.2	335	474	670	821	208	25.0	52.3	111.0	90.0	5	5.6

Spray balls with other spray angles and connection options (various slip-on connections as well as threaded and welded connections) can be found in our brochure "Precision nozzles for tank and equipment cleaning".

Pin	Ordering no.
1	095.013.1Y.06.55
2	095.013.1Y.06.58
3	095.013.1Y.06.56
4	095.013.1Y.06.59
5	095.013.1Y.06.57

The maximum tank diameter applies to the recommended operating pressure and is meant as a recommendation only. The cleaning result is also affected by the type of soiling.

Information about slip-on connections

- Stainless steel 316L pin supplied.
- Depending on the diameter of the adapter, the flow rate can increase due to a leakage between the adapter and the spray ball.

Rotating cleaning nozzle PicoWhirly Series 500.234



Features:

- Cleaning with rotating solid jet
- Compact design for confined spaces
- Suitable for very high temperatures
- Full stainless steel design

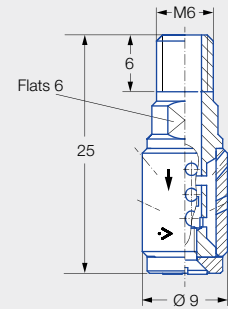

Series 500,234

Male thread

Max. tank diameter [m]	0	1	2	3	4	5	6	7	8	9
-------------------------------	---	---	---	---	---	---	---	---	---	---

Cleaning efficiency class
2

Max. temperature
200°C

Installation
Operation in every direction is possible

Bearing
Kolsterised slide bearing

Material
Stainless steel 316L

Recommended operating pressure
3 bar

Filtration
Line strainer with a mesh size of 0.3 mm/50 mesh

Function video
www.lechler.com/picowhirly
Or scan the QR code.



Spray angle	Ordering no.	Narrowest free cross section \varnothing [mm]	\dot{V} water [l/min]					Max. tank diameter [m]
			p [bar] ($p_{max} = 5$ bar)					
			1.0	2.0	3.0	5.0	at 40 psi [US gal/min]	
300° 	500.234.G9.00	1.8	5.7	8.0	9.8	12.7	2.5	0.9

The maximum tank diameter applies to the recommended operating pressure and is meant as a recommendation only. The cleaning result is also affected by the type of soiling.

Compressed air should be used for dry blowing for a short time only. Operation above the recommended operating pressure has a negative impact on the cleaning result and wear.

Rotating cleaning nozzle MicroWhirly Series 566



Features:

- Cleaning with effective flat jets
- Robust slide bearing made of PEEK
- Equipped with a thread or slip-on connection
- Food grade compatibility



ATEX version available on request

Series 566

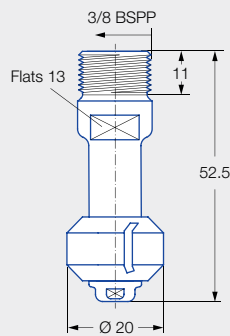

Male thread

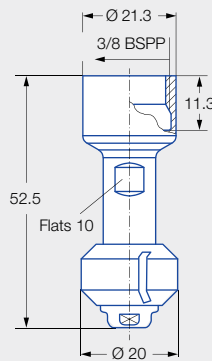

Female thread

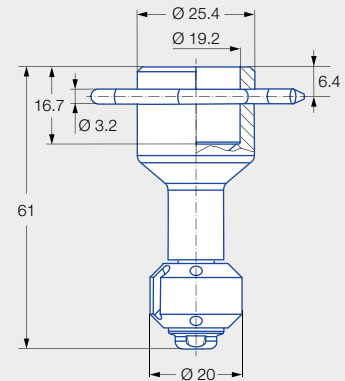

Dimension of the slip-on connection according to ASME-BPE (OD tube)

Max. tank diameter [m]	0	1	2	3	4	5	6	7	8	9
------------------------	---	---	---	---	---	---	---	---	---	---

Cleaning efficiency class
2

Max. temperature
130°C

Installation
Operation in every direction is possible

Bearing
Slide bearing made of PEEK



Material
Stainless steel 316L, PEEK

Recommended operating pressure
2 bar

Filtration
Line strainer with a mesh size of 0.3 mm/50 mesh

Function video
www.lechler.com/microwhirly
Or scan the QR code.



Spray angle	Ordering no.				Narrowest free cross section \varnothing [mm]	\dot{V} water [l/min]				Max. tank diameter [m]
	Type	Code				p [bar] ($p_{max} = 6$ bar)				
		3/8 BSPP	3/8 BSPP	3/4"- Slip-on connection		1.0	2.0	3.0	at 40 psi [US gal/min]	
180° 	566.873.1Y	AE	AF	TF07	1.0	12	15	18	5	1.6
	566.933.1Y	AE	AF	TF07	2.4	15	21	26	7	1.7
180° 	566.874.1Y	AE	AF	TF07	1.0	12	15	18	5	1.6
	566.934.1Y	AE	AF	TF07	2.4	15	21	26	7	1.7
360° 	566.879.1Y	AE	AF	TF07	1.0	12	15	18	5	1.6
	566.939.1Y	AE	AF	TF07	2.4	15	21	26	7	1.7

NPT thread and weld-on version available on request.

The maximum tank diameter applies to the recommended operating pressure and is meant as a recommendation only. The cleaning result is also affected by the type of soiling.

Compressed air should be used for dry blowing for a short time only. Operation above the recommended operating pressure has a negative impact on the cleaning result and wear.

Information about slip-on connections

- Stainless steel 316L pin supplied.
- Depending on the diameter of the adapter, the flow rate can increase due to a leakage between the adapter and the rotating cleaning nozzle.

Ordering Type + Code = Ordering no.
example: 566.873.1Y + AE = 566.873.1Y.AE

Rotating cleaning nozzle MiniWhirly Series 500.186



Features:

- Economical entry-level model
- Cleaning with effective flat jets
- Specifically designed for barrel and canister cleaning



Series 500,186

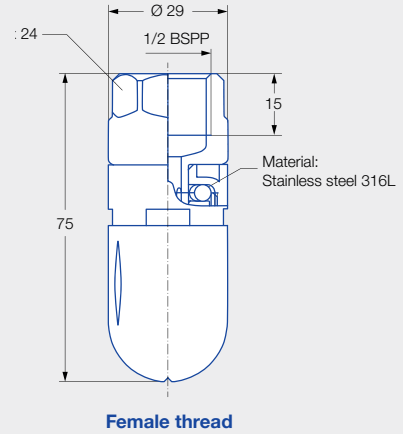

Max. tank diameter [m]	0	1	2	3	4	5	6	7	8	9
------------------------	---	---	---	---	---	---	---	---	---	---



Cleaning efficiency class
2



Max. temperature
50°C



Installation
Vertically facing downwards



Bearing
Ball bearing made of stainless steel



Material
POM, stainless steel 316L



Recommended operating pressure
2 bar



Filtration
Line strainer with a mesh size of 0.3 mm/50 mesh



Function video
www.lechler.com/miniwhirly
Or scan the QR code.

Spray angle	Ordering no.	Narrowest free cross section Ø [mm]	V̇ water [l/min]				Max. tank diameter [m]
			p [bar] (p _{max} = 5 bar)				
			1.0	2.0	3.0	at 40 psi [US gal/min]	
300° 	500.186.56.AH	1.9	13	18	22	6	1.3

The maximum tank diameter applies to the recommended operating pressure and is meant as a recommendation only. The cleaning result is also affected by the type of soiling.

Compressed air should be used for dry blowing for a short time only. Operation above the recommended operating pressure has a negative impact on the cleaning result and wear.

Rotating cleaning nozzle PVDF MicroWhirly Series 500.191



Features:

- Designed for work in a corrosive environment
- Suitable for contact with food and the application of foam
- Very good price-performance ratio
- Made entirely of PVDF

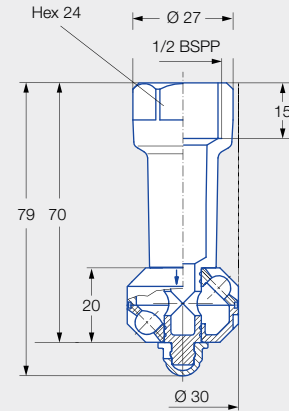

Series 500.191

Female thread

Max. tank diameter [m]	0	1	2	3	4	5	6	7	8	9
------------------------	---	---	---	---	---	---	---	---	---	---



Cleaning efficiency class
2



Max. temperature
90°C



Installation
Operation in every direction is possible



Bearing
Slide bearing made of PVDF



Material
PVDF



Recommended operating pressure
2 bar



Filtration
Line strainer with a mesh size of 0.3 mm/50 mesh

Function video

www.lechler.com/microwhirly
Or scan the QR code.



Spray angle	Ordering no. Type	Narrowest free cross section Ø [mm]	V̇ water [l/min]				Max. tank diameter [m]
			p [bar] (p _{max} = 5 bar)				
			1.0	2.0	3.0	at 40 psi [US gal/min]	
180° 	500.191.5E.02	2.2	9	13	16	4	0.8
180° 	500.191.5E.01	2.2	9	13	16	4	0.8
270° 	500.191.5E.31	2.2	14	20	25	6	1.1
360° 	500.191.5E.00	2.2	14	20	25	6	1.1

The maximum tank diameter applies to the recommended operating pressure and is meant as a recommendation only. The cleaning result is also affected by the type of soiling.

The PVDF MicroWhirly is not suitable for operation with compressed air or any other gas. Operation above the recommended operating pressure has a negative impact on the cleaning result and wear.

Rotating cleaning nozzle NanoSpinner2 Series 5M1



Features:

- Compact design for confined spaces
- Hygienic design
- Suitable for high temperatures
- Made entirely of stainless steel



ATEX version available on request

Series 5M1

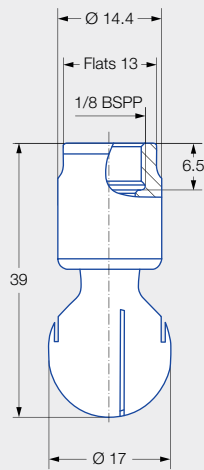

Female thread

Max. tank diameter [m]	0	1	2	3	4	5	6	7	8	9
------------------------	---	---	---	---	---	---	---	---	---	---



Cleaning efficiency class
2



Max. temperature
250 °C



Installation
Operation in every direction is possible



Bearing
Double ball bearing made of stainless steel 316L



Material
Stainless steel 316L



Recommended operating pressure
2 bar



Filtration
Line strainer with a mesh size of 0,1mm/170 mesh

Function video
www.lechler.com/de-en/medialibrary
Or scan the QR Code.



Spray angle	Ordering number	Narrowest free cross section \varnothing [mm]	\dot{V} water [l/min]				Max. tank diameter [m]
	Type 1/8 BSPP		p [bar] ($p_{max} = 7$ bar)				
			1.0	2.0	3.0	at 40 psi [US gal/min]	
360° 	5M1.879.1Y.AB	0.4	11	15	18	5	1.4
	5M1.929.1Y.AB	0.5	14	20	25	6	1.6

NPT thread available on request.

The maximum tank diameter applies to the recommended operating pressure and is meant as a recommendation only.
The cleaning result is also affected by the type of soiling.

Compressed air should be used for dry blowing for a short time only. Operation above the recommended operating pressure has a negative impact on the cleaning result and wear.

Rotating cleaning nozzle MicroSpinner 2 Series 5M2



Features:

- Hygienic design
- Suitable for high temperatures
- Made entirely of stainless steel



ATEX version available on request

Series 5M2

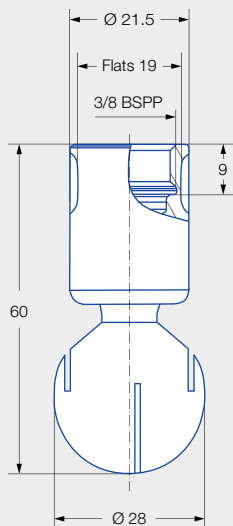

Female thread

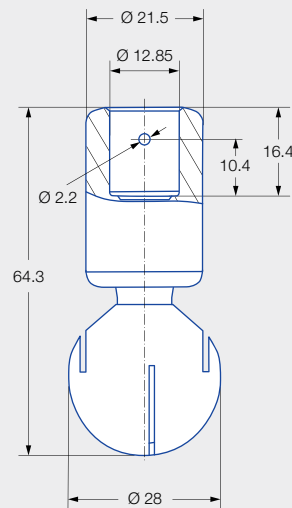

Dimensions of the slip-on connection according to ASME-BE (OD-tube)

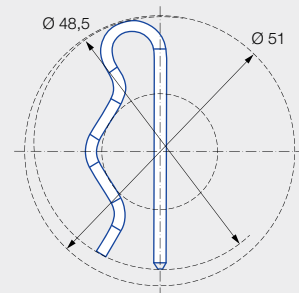

Dimensions of the slip-on connection top view

Max. tank diameter [m]	0	1	2	3	4	5	6	7	8	9
------------------------	---	---	---	---	---	---	---	---	---	---



Cleaning efficiency class
2



Max. temperature
250 °C



Installation
Operating in every direction possible



Bearing
Double ball bearing made of stainless steel 316L



Material
Stainless steel 316L



Recommended operating pressure
2 bar



Filtration
Line strainer with a mesh size of 0,1mm/170 mesh





Adapter
3/8 BSPP is compatible with HygienicFit

Function video

www.lechler.com/de-en/medialibrary
Or scan the QR Code.



Spray angle	Ordering number			Narrowest free cross section \varnothing [mm]	V water [l/min]				Max. tank diameter [m]
	Type	Connection			p [bar] (p _{max} = 7 bar)				
		3/8 BSPP	1/2"-Slip-on		1.0	2.0	3.0	at 40 psi [US gal/min]	
60° 	5M2.952.1Y	AF	TF05	1.5	16	23	28	7	–
	5M2.042.1Y	AF	TF05	3.0	28	40	49	12	–
180° 	5M2.004.1Y	AF	TF05	0.9	22	32	39	10	1.8
360° 	5M2.969.1Y	AF	TF05	0.8	18	25	31	8	1.7
	5M2.049.1Y	AF	TF05	0.9	28	39	48	12	1.8

NPT thread, weld-on and further slip-on versions on request.

The max. tank diameter shown above applies for the recommended operating pressure and has to be seen as a recommendation. The cleaning result is also affected by the type of soiling.

Operating with compressed air only for short-term usage. Operation above the recommended operating pressure has negative effects on the cleaning result and wear.

Information slip-on connection

- Pin made of stainless steel 316L included (ordering no. 05M.230.1Y.00.00.0).
- Depending on diameter of the adapter, the flow rate increase due to leakage between connecting pipe and rotating cleaning nozzle.
- Minimum insertion diameter (with mounted pin) is 48,5 mm

Example of ordering: Type 5M2.952.1Y + Connection AF = Ordering no. 5M2.952.1Y.AF

Rotating cleaning nozzle MiniSpinner 2 Series 5M3



Features:

- Hygienic design
- Suitable for high temperatures
- Made entirely of stainless steel



**ATEX version
available on
request**

Series 5M3

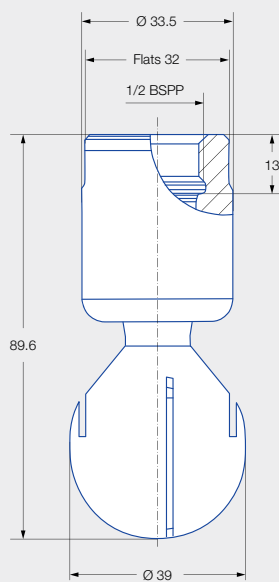

Female thread

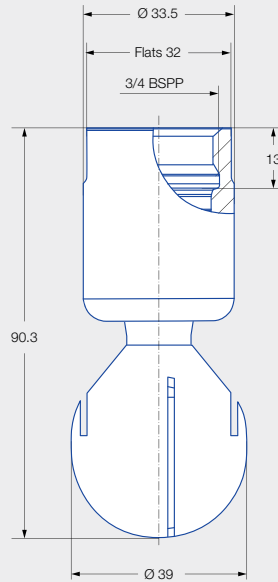

Female thread

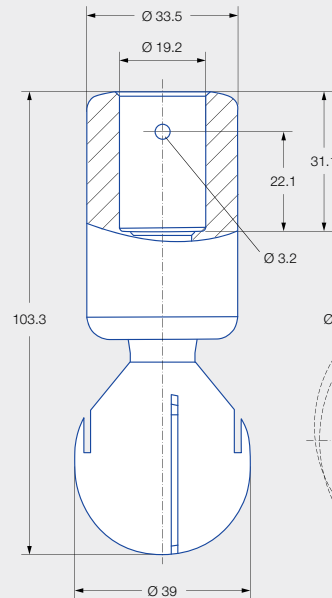

Dimensions of the
slip-on connection according
to ASME-BE (OD-tube)

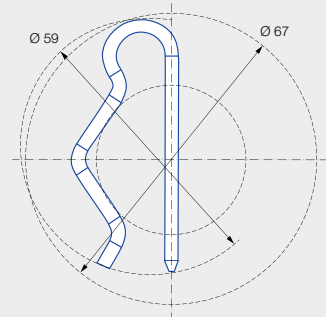

Dimensions of the
slip-on connection
top view

Max. tank diameter [m]	0	1	2	3	4	5	6	7	8	9
------------------------	---	---	---	---	---	---	---	---	---	---

Cleaning efficiency class
2

Max. temperature
250 °C

Installation
Operating in every direction possible

Bearing
Double ball bearing made of stainless steel 316L

Material
Stainless steel 316L





Recommended operating pressure
2 bar

Filtration
Line strainer with a mesh size of 0,1mm/170 mesh

Adapter
1/2 BSPP and 3/4 BSPP are compatible with HygienicFit

Function video
www.lechler.com/de-en/medialibrary
Or scan the QR Code.



Spray angle	Ordering no.				Narrowest free cross section \varnothing [mm]	\dot{V} water [l/min]				Max. tank diameter [m]
	Type	Connection				p [bar] ($p_{\max} = 7$ bar)				
		1/2 BSP	3/4 BSP	3/4"-Slip-on		1.0	2.0	3.0	at 40 psi [US gal/min]	
60° 	5M3.122.1Y	AH		TF07	2.6	45	63	77	20	-
180° 	5M3.133.1Y		AL	TF07	1.2	47	67	82	21	2.6
180° 	5M3.134.1Y		AL	TF07	1.3	47	67	82	21	2.6
360° 	5M3.999.1Y		AL	TF07	0.4	21	30	37	9	1.8
	5M3.089.1Y		AL	TF07	0.7	35	49	60	15	2.1
	5M3.139.1Y		AL	TF07	0.8	49	69	85	21	2.3
	5M3.209.1Y		AL	TF07	1.5	71	100	122	31	2.6

NPT thread, weld-on and further slip-on versions on request.

The max. tank diameter shown above applies for the recommended operating pressure and has to be seen as a recommendation. The cleaning result is also affected by the type of soiling.

Operating with compressed air only for short-term usage. Operation above the recommended operating pressure has negative effects on the cleaning result and wear.

Information slip-on connection

- Pin made of stainless steel 316L included (Ordering no. 05M.330.1Y.00.00.0).
- Depending on diameter of the adapter, the flow rate increase due to leakage between connecting pipe and rotating cleaning nozzle.
- Minimum insertion diameter (with mounted pin) is 59 mm.

Example Type + Connection = Ordering no.
of ordering: 5M3.122.1Y + AH = 5M3.122.1Y.AH

Rotating cleaning nozzle MaxiSpinner 2 Series 5M4



Features:

- Hygienic design
- Suitable for high temperatures
- Made entirely of stainless steel



**ATEX version
available on
request**

Series 5M4

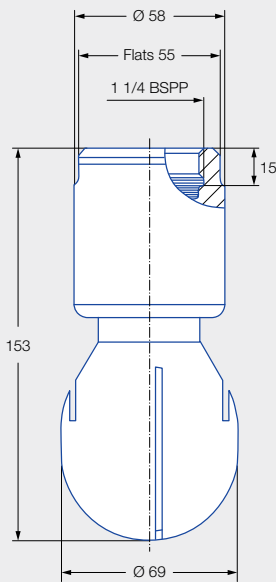

Female thread

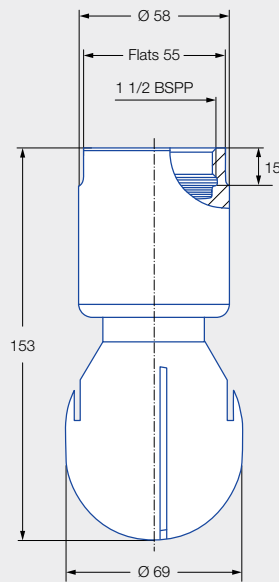

Female thread

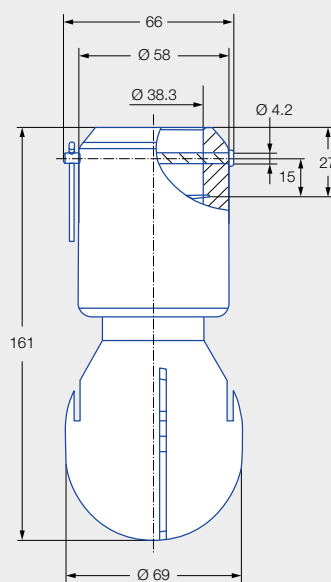

Dimensions of the
1 1/2" slip-on connection according
to ASME-BE (OD-tube)

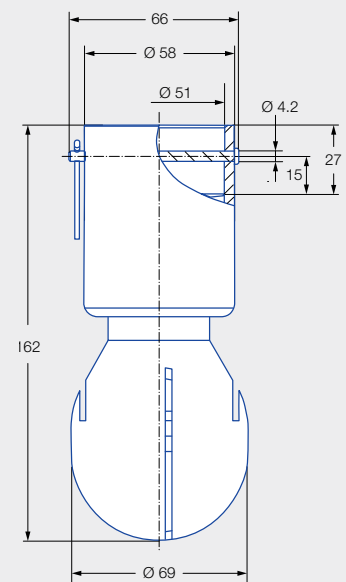

Dimensions of the
2" slip-on connection according
to ASME-BE (OD-tube)

Max. tank diameter [m]	0	1	2	3	4	5	6	7	8	9
------------------------	---	---	---	---	---	---	---	---	---	---

Cleaning efficiency class
2

Max. temperature
250 °C

Installation
Operating in every direction possible

Bearing
Double ball bearing made of stainless steel 316L

Material
Stainless steel 316L

Recommended operating pressure
2 bar

Filtration
Line strainer with a mesh size of 0,1mm/170 mesh

Adapter
1 1/4 BSPP and 1 1/2 BSPP are compatible with HygienicFit

Function video
www.lechler.com/de-en/medialibrary
Or scan the QR Code.



Spray angle	Ordering no.					Narrowest free cross section \varnothing [mm]	\dot{V} water [l/min]				Max. tank diameter [m]
	Type	Connection					p [bar] ($p_{max} = 7$ bar)*				
		1 1/4 BSP	1 1/2 BSP	1 1/2" Slip-on	2"- Slip-on		1,0	2,0	3,0	at 40 psi [US gal/min]	
360° 	5M4.279.1Y	AQ	AS	TF15	TF20	1.7	107	150	184	46	4.0
	5M4.329.1Y	AQ	AS	TF15	TF20	2.0	141	200	245	62	4.5
	5M4.369.1Y	AQ	AS	TF15	TF20	2.3	177	250	306	78	5.0

NPT thread and weld-on versions on request.

* Please note the maximum operating pressure of 4 bar for the 2" slip-on connection.

The max. tank diameter shown above applies for the recommended operating pressure and has to be seen as a recommendation. The cleaning result is also affected by the type of soiling

Operating with compressed air only for short-term usage. Operation above the recommended operating pressure has negative effects on the cleaning result and wear.

Information slip-on connection

- Bolt with head incl. pin made of stainless steel 316L included (Ordering no. 05M.431.1Y.00.00.0).
- Depending on diameter of the adapter, the flow rate increase due to leakage between connecting pipe and rotating cleaning nozzle.
- Minimum insertion diameter (with mounted bolt) is the same as for the threaded variants 69 mm.

Example Type + Connection = Ordering no.
of ordering: 5M4.369.1Y + AQ = 5M4.369.1Y.AQ

Rotating cleaning nozzle PTFE Whirly Series 573/583



Features:

- Made entirely of PTFE
- Slip-on connection conforms to 3-A
- Suitable for corrosive environments
- Suitable for very hygienic requirements (e.g. contact with food)



Series 573/583

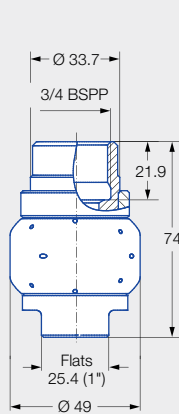

Female thread
3/4 BSPP

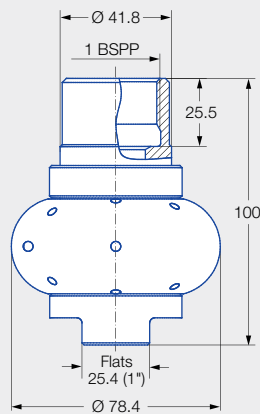

Female thread
1 BSPP

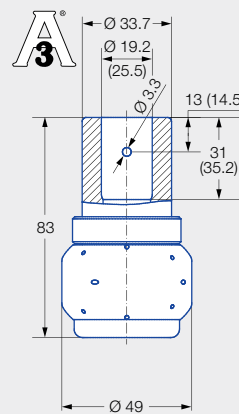

3/4" and 1" slip-on connection
(conforms to 3-A)
Dimension of the slip-on
connection according to
ASME-BPE (OD tube)

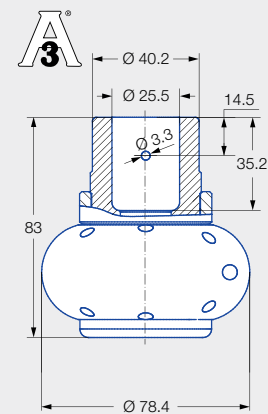

1" slip-on connection
(conforms to 3-A)
Dimension of the slip-on
connection according to
ASME-BPE (OD tube)

Data in brackets refers to 1" version marked with "1".

Max. tank diameter [m]	0	1	2	3	4	5	6	7	8	9
------------------------	---	---	---	---	---	---	---	---	---	---

Cleaning efficiency class
2

Max. temperature
95 °C (version for higher temperatures [130 °C] available on request)

Installation
Operation in every direction is possible

Bearing
Slide bearing made of PTFE



Material
PTFE

Recommended operating pressure
2 bar

Filtration
Line strainer with a mesh size of 0.3 mm/50 mesh

Function video
www.lechler.com/ptfewhirly
Or scan the QR code.



Spray angle	Ordering no.					Narrowest free cross section Ø [mm]	V̇ water [l/min]				Pin	Max. tank diameter [m]
	Type	Code					p [bar] (p _{max} = 6 bar)					
		3/4 BSPP	1 BSPP	3/4" Slip-on connection	1" Slip-on connection		1.0	2.0	3.0	at 40 psi [US gal/min]		
270° 	583.116.55	AL		TF07		2.4	47	67	82	21	1	2.5
	583.346.55				TF10	5.9	159	225	276	70	2	3.2
270° 	573.116.55	AL		TF07		2.4	47	67	82	21	1	2.5
360° 	583.119.55	AL		TF07	TF10 ¹	1.8	41	58	71	18	1	2.4
	583.209.55	AL		TF07	TF10 ¹	3.5	71	100	122	31	1	2.5
	583.269.55	AL		TF07		4.8	103	145	178	45	1	2.8
	583.279.55		AN		TF10	3.7	106	150	184	47	2	3.0
	583.349.55		AN		TF10	5.6	159	225	276	70	2	3.2

NPT thread available on request.

¹ See drawing 3 for details (Page 204).

The maximum tank diameter applies to the recommended operating pressure and is meant as a recommendation only. The cleaning result is also affected by the type of soiling.

Compressed air should be used for dry blowing for a short time only. Operation above the recommended operating pressure has a negative impact on the cleaning result and wear.

Information about slip-on connections

- Pin made of stainless steel 316L supplied (Ordering no. Pin 1: 095.013.17.06.60, Pin 2: 095.013.17.06.61).
- Depending on the diameter of the adapter, the flow rate can increase due to a leakage between the adapter and the rotating cleaning nozzle.

Ordering	Type	+	Code	=	Ordering no.
example:	583.116.55	+	AL	=	583.116.55.AL

Extendable rotating cleaning nozzle PopUp Whirly Series 5P2/5P3



Features:

- Pressure-dependent automatically extending rotating cleaning nozzle
- Can be installed flush in the tank wall
- Suitable for cleaning pipes and applications that use foam
- Particularly suitable for applications in the pharmaceutical, chemical and food and beverage industry



Series 5P2



Series 5P3



**ATEX version
available on
request**

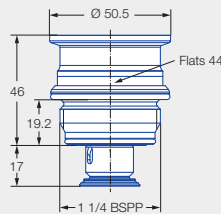

Male thread

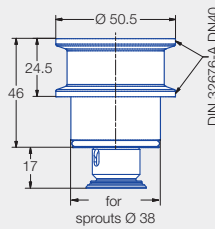

Tri-Clamp connection¹

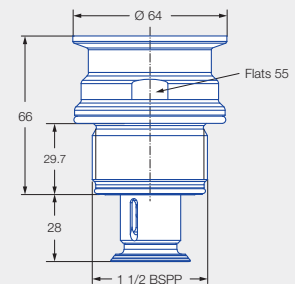
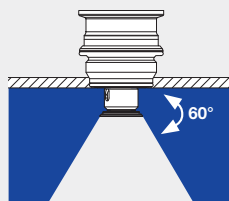

Male thread

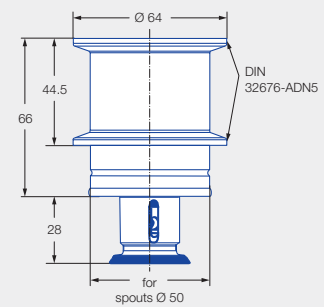

Tri-Clamp connection²

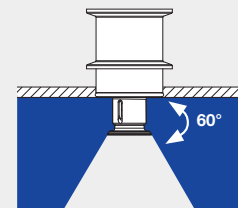

Installation situation

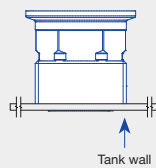

Via thread in idle position

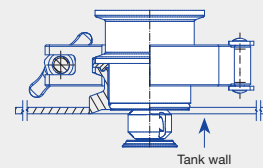

Via Tri-Clamp in operating position

¹ A clamp according to DIN 32676-A with a connection diameter of 50.5 mm is required to connect the nozzle to the weld-in flange.

² A clamp according to DIN 32676-A with a connection diameter of 64.0 mm is required to connect the nozzle to the weld-in flange.

Weld-in flange for Tri-Clamp connection

A 2 mm thick gasket must be used if the PopUp Whirly is installed with the weld-in flange.

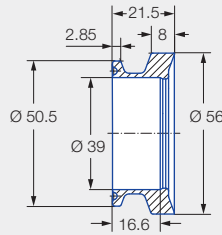

Ordering no.: 050.020.1Y.01.00
Material: Stainless steel 316L

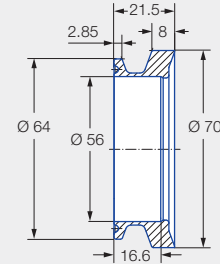

Ordering no.: 050.020.1Y.01.01
Material: Stainless steel 316L

Max. tank diameter [m]	0	1	2	3	4	5	6	7	8	9
------------------------	---	---	---	---	---	---	---	---	---	---



Cleaning efficiency class
2



Max. temperature
140°C



Installation
Operation in every direction is possible



Bearing
Slide bearing



Material
Stainless steel 316L,
stainless steel 316Ti,
stainless steel 316,
FKM



Recommended operating pressure
2 bar
5P2: Opening pressure approx. 1.0 bar, closing pressure approx. 0.5 bar,
5P3: Opening pressure approx. 0.9 bar, closing pressure approx. 0.5 bar



Filtration
Line strainer with a mesh size of 0.3 mm/50 mesh



Function video
www.lechler.com/popupwhirly
Or scan the QR code.

Spray angle	Ordering no.				Narrowest free cross section Ø [mm]	V̇ water [l/min]				Max. tank diameter [m]
	Type	Code				p [bar] (p _{max} = 6 bar)				
		1 1/4 BSPP	1 1/2 BSPP	Tri-Clamp		1.0	2.0	3.0	at 40 psi [US gal/min]	
	5P2.873.1Y.AP	●			3.0	11	15	18	5	0.8
	5P2.873.1Y.00			●	3.0	11	15	18	5	0.8
	5P2.923.1Y.AP	●			3.5	14	20	25	6	1.0
	5P2.923.1Y.00			●	3.5	14	20	25	6	1.0
	5P3.043.1Y.AR		●		3.3	28	40	49	12	2.2
	5P3.043.1Y.00			●	3.3	28	40	49	12	2.2

The maximum tank diameter applies to the recommended operating pressure and is meant as a recommendation only. The cleaning result is also affected by the type of soiling.

Information on operation

- The PopUp Whirly is not suitable for operation with compressed air or any other gas.
- Operation above the recommended operating pressure has a negative impact on the cleaning result and wear.

Rotating cleaning nozzle HygienicWhirly Series 594/595



Features:

- Cleaning with highly effective flat jets
- Good cleaning effect even at low pressure
- Suitable for the application of foam



Series 594/595

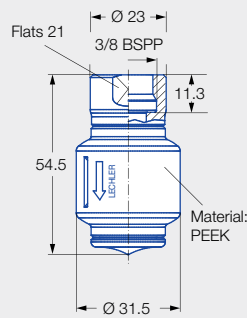

Standard version/Female thread
59x.xx9.1Y.AF

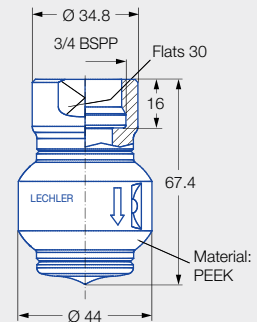

Standard version/Female thread
595.139.1Y.AL

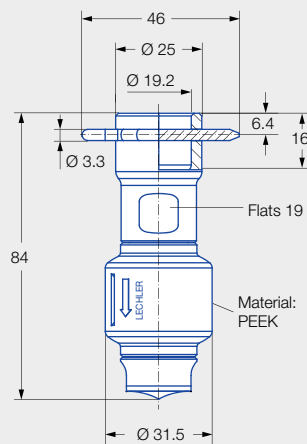

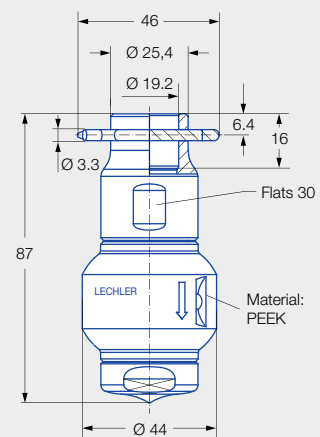

Dimension of the slip-on connection according to ASME-BPE (OD tube)
59x.xx9.1Y.67



Dimension of the slip-on connection according to ASME-BPE (OD tube)
595.139.1Y.67

 Max. tank diameter [m]	0	1	2	3	4	5	6	7	8	9
---	---	---	---	---	---	---	---	---	---	---

 **Cleaning efficiency class**
3

 **Max. temperature**
100 °C, short term
up to 140 °C

 **Installation**
Operation in every
direction is possible

 **Bearing**
Slide bearing made of
PEEK

 **Material**
Stainless steel 316L,
PEEK, version with slip-on
connection O-ring made
of EPDM

 **Recommended operating pressure**
3 bar

 **Filtration**
Line strainer with a mesh
size of 0.3 mm/50 mesh

Function video
www.lechler.com/hygienicwhirly
Or scan the QR code.



Spray angle	Ordering no.				Narrowest free cross section \varnothing [mm]	\dot{V} water [l/min]						Max. tank diameter [m]
	Type	Code				p [bar] ($p_{max} = 6$ bar)						
		3/8 BSPP	3/4 BSPP	3/4" slip-on connection		0.5	1.0	2.0	3.0	5.0	at 40 psi [US gal/min]	
360° 	594.829.1Y	AF		67	1.7	6	8	11	14	18	3	0.8
	594.879.1Y	AF		67	2.5	8	11	15	18	23	5	1.2
	595.009.1Y	AF		67	4.0	16	22	32	39	50	10	1.5
	595.049.1Y	AF		67	4.2	20	28	40	49	63	12	2.0
	595.139.1Y		AL	67	5.0	34	47	67	82	106	21	2.7

NPT thread available on request.

The maximum tank diameter applies to the recommended operating pressure and is meant as a recommendation only. The cleaning result is also affected by the type of soiling.

Compressed air should be used for dry blowing for a short time only. Operation above the recommended operating pressure has a negative impact on the cleaning result and wear.

Information about slip-on connections

- Pin made of stainless steel 316L supplied (Ordering no.: 095.022.1Y.50.94.E).
- Depending on the diameter of the adapter, the flow rate can increase due to a leakage between the adapter and the rotating cleaning nozzle.

Ordering	Type	+	Code	=	Ordering no.
example:	594.829.1Y	+	AF	=	594.829.1Y.AF

Rotating cleaning nozzle Whirly 2 Series 5W9



Features:

- Popular and proven design
- Cleaning with effective flat jets
- Various connection options
- Available with a wide range of flow rates and spray angles



**ATEX version
available on
request**

Series 5W9

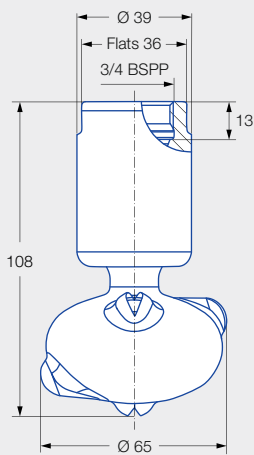

Female thread

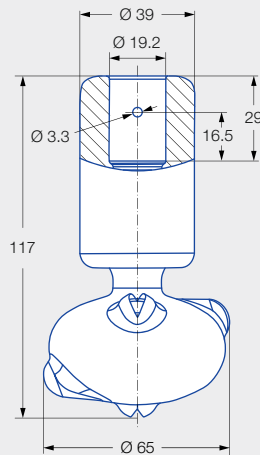

Dimensions slip-on connection
according to ASME-BPE (OD-tube)

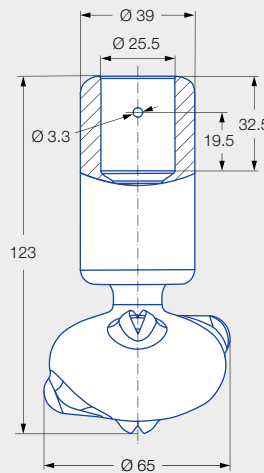

Dimensions slip-on connection
according to ASME-BPE (OD-tube)

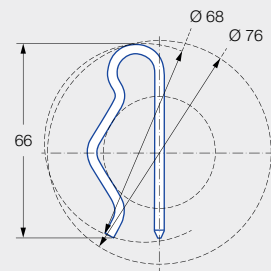

Dimensions slip-on connection
top view

Max. tank diameter [m]	0	1	2	3	4	5	6	7	8	9
------------------------	---	---	---	---	---	---	---	---	---	---



Cleaning efficiency class
3



Max. temperature
140°C



Installation
Operation in every direction is possible



Bearing
Double ball bearing made of stainless steel



Material
Stainless steel 316L, PEEK



Recommended operating pressure
2 bar



Filtration
Line strainer with a mesh size of 0.1 mm/170 mesh





Adapter
3/4 BSPP is compatible with HygienicFit

[Function video](#)

www.lechler.com/de-en/medialibrary
Or scan the QR Code.



Spray angle	Ordering no.				Narrowest free cross section \varnothing [mm]	\dot{V} water [l/min]				Max. tank diameter [m]
	Type	Code				p [bar] ($p_{max} = 6$ bar)				
		3/4 BSPP	3/4" Slip-on connection	1" Slip-on connection		1.0	2.0	3.0	at 40 psi [US gal/min]	
270° 	5W9.075.1Y	AL	TF07	TF10	2.0	34	48	59	15	1.8
	5W9.145.1Y	AL	TF07	TF10	2.8	50	71	87	22	2.1
	5W9.195.1Y	AL	TF07	TF10	3.3	69	97	119	30	2.6
270° 	5W9.076.1Y	AL	TF07	TF10	2.0	34	48	59	15	1.8
	5W9.106.1Y	AL	TF07	TF10	2.5	41	58	71	18	2.1
	5W9.196.1Y	AL	TF07	TF10	3.4	69	97	119	30	2.6
360° 	5W9.079.1Y	AL	TF07	TF10	1.6	34	48	59	15	1.8
	5W9.149.1Y	AL	TF07	TF10	2.4	50	71	87	22	2.1
	5W9.199.1Y	AL	TF07	TF10	3.0	69	97	119	30	2.6
	5W9.279.1Y	AL	TF07	TF10	3.5	103	145	178	45	3.0

NPT thread available on request.

The maximum tank diameter applies to the recommended operating pressure and is meant as a recommendation only. The cleaning result is also affected by the type of soiling.

Compressed air should be used for dry blowing for a short time only. Operation above the recommended operating pressure has a negative impact on the cleaning result and wear.

Information about slip-on connections

- Pin made of stainless steel 316L supplied (Ordering no.: 095.013.1Y.06.72.0).
- Depending on the diameter of the adapter, the flow rate can increase due to a leakage between the adapter and the rotating cleaning nozzle.
- Minimum insertion diameter (with mounted pin) is 68 mm.

Ordering	Type	+	Code	=	Ordering no.
example:	5W9.075.1Y	+	AL	=	5W9.075.1Y.AL

Rotating cleaning nozzle Gyro Series 577



Features:

- Cleaning with powerful nozzle inserts
- Suitable for very large tanks
- Available with a wide range of flow rates
- Non clogging and large free cross sections



Series 577

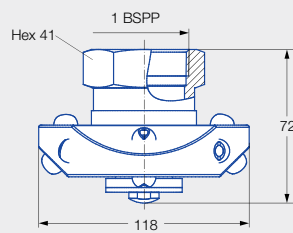

Female thread

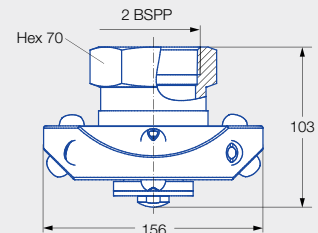

Female thread

Max. tank diameter [m]	0	1	2	3	4	5	6	7	8	9
------------------------	---	---	---	---	---	---	---	---	---	---

Cleaning efficiency class
3

Max. temperature
90°C

Installation
Vertically facing downwards

Bearing
Slide bearing made of PTFE

Material
Stainless steel 316L, PTFE

Recommended operating pressure
3 bar

Filtration
Line strainer with a mesh size of 0.3 mm/50 mesh

Function video
www.lechler.com/gyro
Or scan the QR code.



Spray angle	Ordering no.			V̇ water [l/min]					Max. tank diameter [m]
	Type	Code		p [bar] (p _{max} = 5 bar)					
		1 BSPP	2 BSPP	1.0	2.0	3.0	5.0	at 40 psi [US gal/min]	
 360°	577.289.1Y	AN		115	163	200	258	50	3.4
	577.369.1Y	AN		182	258	316	408	80	3.9
	577.409.1Y		AW	228	322	394	509	100	4.2
	577.439.1Y		AW	273	386	473	610	120	4.6
	577.499.1Y		AW	380	538	659	851	170	5.4

NPT thread available on request.

The maximum tank diameter applies to the recommended operating pressure and is meant as a recommendation only. The cleaning result is also affected by the type of soiling.

Compressed air should be used for dry blowing for a short time only. Operation above the recommended operating pressure has a negative impact on the cleaning result and wear.

Ordering **Type** + **Code** = **Ordering no.**
example: 577.289.1Y + AN = 577.289.1Y.AN

Rotating cleaning nozzle XactClean HP Series 5S2/5S3



Features:

- High impact and uniform cleaning due to specially developed flat fan nozzles
- Very reliable due to robust drive unit
- Available with a wide range of flow rates and spray angles
- Compatible with Lechler rotation monitoring sensor

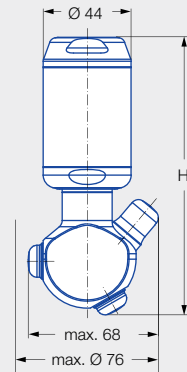

Female thread



ATEX version available on request

Series 5S2/5S3

Nozzle dimensions [mm]

Connection	Max. height H
AF	146
AH	149
AL	139
AN	139
TF05	148
TF07	164

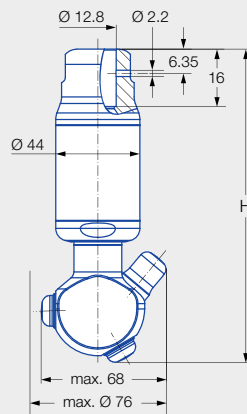

1/2" slip-on connection
Dimension of the slip-on connection according to ASME-BPE (OD tube)

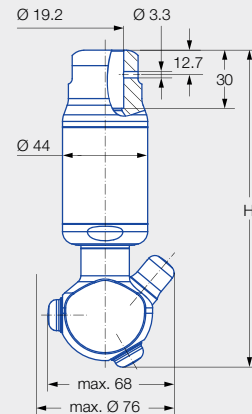

3/4" slip-on connection
Dimension of the slip-on connection according to ASME-BPE (OD tube)

Max. tank diameter [m]	0	1	2	3	4	5	6	7	8	9



Cleaning efficiency class
4



Max. temperature
95°C



Installation
Operation in every direction is possible



Bearing
Double ball bearing



Material
Stainless steel 316L, stainless steel 632, stainless steel 316, PEEK, PTFE, zirconium oxide, EPDM



Recommended operating pressure
5 bar



Filtration
Line strainer with a mesh size of 0.3 mm/50 mesh



Rotation monitoring
Sensor compatible, for information: See Page 221





Function video

www.lechler.com/xactcleanhp

Or scan the QR code.





Spray angle	Ordering no.							Narrowest free cross section Ø [mm]	V̇ water [l/min]				Max. tank diameter [m]
	Type	Code							p [bar] (p _{max} = 15 bar)				
		3/8 BSPP	1/2 BSPP	3/4 BSPP	1 BSPP	1/2" Slip-on connection	3/4" Slip-on connection		2.0	5.0	10.0	at 40 psi [US gal/min]	
180° 	5S2.953.1Y	AF	AH			TF05		1.7	25	40	57	8	3.5
	5S3.053.1Y		AH				TF07	2.0	41	65	92	13	4.0
	5S3.113.1Y		AH	AL			TF07	2.0	60	94	133	18	6.0
	5S3.183.1Y			AL			TF07	2.0	89	141	199	28	7.0
	5S3.233.1Y			AL			TF07	2.0	111	175	248	34	7.5
	5S3.263.1Y			AL	AN		TF07	2.0	135	213	301	42	8.0
180° 	5S2.954.1Y	AF	AH			TF05		1.7	25	40	57	8	3.5
	5S3.054.1Y		AH				TF07	2.0	41	65	92	13	4.0
	5S3.114.1Y		AH	AL			TF07	2.0	60	94	133	18	6.0
	5S3.184.1Y			AL			TF07	2.0	89	141	199	28	7.0
	5S3.234.1Y			AL			TF07	2.0	111	175	248	34	7.5
	5S3.264.1Y			AL	AN		TF07	2.0	135	213	301	42	8.0
270° 	5S2.955.1Y	AF	AH			TF05		1.7	25	40	57	8	3.5
	5S3.055.1Y		AH				TF07	2.0	41	65	92	13	4.0
	5S3.115.1Y		AH	AL			TF07	2.0	60	94	133	18	6.0
	5S3.185.1Y			AL			TF07	2.0	89	141	199	28	7.0
	5S3.235.1Y			AL			TF07	2.0	111	175	248	34	7.5
	5S3.265.1Y			AL	AN		TF07	2.0	135	213	301	42	8.0
270° 	5S2.956.1Y	AF	AH			TF05		1.7	25	40	57	8	3.5
	5S3.056.1Y		AH				TF07	2.0	41	65	92	13	4.0
	5S3.116.1Y		AH	AL			TF07	2.0	60	94	133	18	6.0
	5S3.186.1Y			AL			TF07	2.0	89	141	199	28	7.0
	5S3.236.1Y			AL			TF07	2.0	111	175	248	34	7.5
	5S3.266.1Y			AL	AN		TF07	2.0	135	213	301	42	8.0
360° 	5S2.959.1Y	AF	AH			TF05		1.5	25	40	57	8	3.5
	5S3.059.1Y		AH				TF07	2.0	41	65	92	13	4.0
	5S3.119.1Y		AH	AL			TF07	2.0	60	94	133	18	6.0
	5S3.189.1Y			AL			TF07	2.0	89	141	199	28	7.0
	5S3.239.1Y			AL			TF07	2.0	111	175	248	34	7.5
	5S3.269.1Y			AL	AN		TF07	2.0	135	213	301	42	8.0

NPT thread available on request.

The maximum tank diameter applies to the recommended operating pressure and is meant as a recommendation only.
The cleaning result is also affected by the type of soiling.

Compressed air should be used for dry blowing for a short time only. Operation above the recommended operating pressure has a negative impact on the cleaning result and wear.

Information about slip-on connections

- Pin made of stainless steel 316L supplied (Ordering no.: 095.022.1Y.50.60.E [TF07], 095.013.1E.05.59 [TF05]).
- Depending on the diameter of the adapter, the flow rate can increase due to a leakage between the adapter and the rotating cleaning nozzle.

Ordering	Type	+	Code	=	Ordering no.
example:	5S2.953.1Y	+	AF	=	5S2.953.1Y.AF

Rotating cleaning nozzle XactClean HP+ Series 5S5



Features:

- High impact and uniform cleaning due to specially developed flat fan nozzles
- Effective cleaning of larger tanks due to higher flow rates
- High dependability and operational reliability due to robust drive unit
- Compatible with Lechler rotation monitoring sensor



Series 5S5

Nozzle dimensions [mm]

Connection	Max. height H
AN	185
AQ	185
AS	187

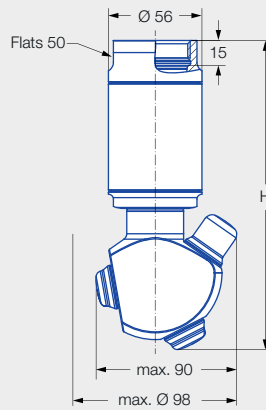

Female thread

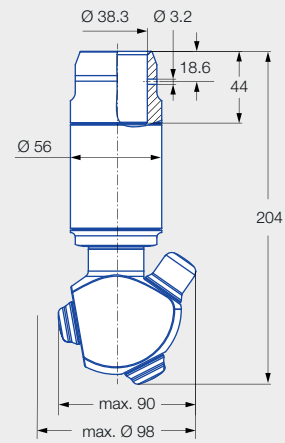

Dimension of the slip-on connection according to ASME-BPE (OD tube)

Max. tank diameter [m]	0	1	2	3	4	5	6	7	8	9



Cleaning efficiency class
4



Max. temperature
95°C



Installation
Operation in every direction is possible



Bearing
Double ball bearing



Material
Stainless steel 316L, stainless steel 316, PEEK, EPDM



Recommended operating pressure
3 bar



Filtration
Line strainer with a mesh size of 0.3 mm/50 mesh



Rotation monitoring
Sensor compatible, for information: See Page 221







Adapter
1 BSPP, 1 1/4 BSPP and 1 1/2 BSPP are compatible with HygienicFit

Function video

www.lechler.com/xactcleanhpplus
Or scan the QR code.





Spray angle	Ordering no.					Narrowest free cross section \varnothing [mm]	\dot{V} water [l/min]				Max. tank diameter [m]
	Type	Code					p [bar] ($p_{max} = 10$ bar)				
		1 BSPP	1 1/4 BSPP	1 1/2 BSPP	1 1/2"-Slip-on connection		2.0	3.0	5.0	at 40 psi [US gal/min]	
180° 	5S5.293.1Y	AN			TF15	3.0	165	202	261	51	9.0
	5S5.323.1Y	AN	AQ		TF15	3.0	200	245	316	62	9.2
	5S5.363.1Y		AQ	AS	TF15	3.0	250	306	395	78	9.4
180° 	5S5.294.1Y	AN			TF15	3.0	165	202	261	51	9.0
	5S5.324.1Y	AN	AQ		TF15	3.0	200	245	316	62	9.2
	5S5.364.1Y		AQ	AS	TF15	3.0	250	306	395	78	9.4
270° 	5S5.295.1Y	AN			TF15	3.0	165	202	261	51	9.0
	5S5.325.1Y	AN	AQ		TF15	3.0	200	245	316	62	9.2
	5S5.365.1Y		AQ	AS	TF15	3.0	250	306	395	78	9.4
270° 	5S5.296.1Y	AN			TF15	3.0	165	202	261	51	9.0
	5S5.326.1Y	AN	AQ		TF15	3.0	200	245	316	62	9.2
	5S5.366.1Y		AQ	AS	TF15	3.0	250	306	395	78	9.4
360° 	5S5.299.1Y	AN			TF15	3.0	165	202	261	51	9.0
	5S5.329.1Y	AN	AQ		TF15	3.0	200	245	316	62	9.2
	5S5.369.1Y		AQ	AS	TF15	3.0	250	306	395	78	9.4
	5S5.399.1Y		AQ	AS	TF15	3.0	300	367	474	93	9.6

NPT thread available on request.

The maximum tank diameter applies to the recommended operating pressure and is meant as a recommendation only. The cleaning result is also affected by the type of soiling.

Compressed air should be used for dry blowing for a short time only. Operation above the recommended operating pressure has a negative impact on the cleaning result and wear.

Information about slip-on connections

- Pin made of stainless steel 316L supplied (Ordering no.: 095.013.1Y.06.45).
- Depending on the diameter of the adapter, the flow rate can increase due to a leakage between the adapter and the rotating cleaning nozzle.

Ordering Type + Code = Ordering no.
example: 5S5.293.1Y + AN = 5S5.293.1Y.AN

High impact cleaner IntenseClean Hygienic Series 5TA

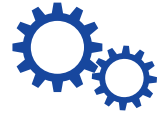

Features:

- High degree of effectiveness due to particularly powerful solid stream nozzles
- Suitable for smaller tanks with stubborn dirt
- Suitable for pressure levels up to 15 bar
- High surface quality



Series 5TA



ATEX version available on request

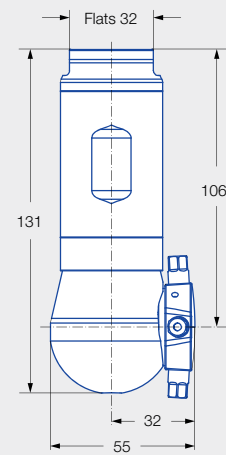
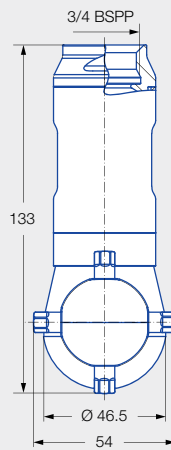
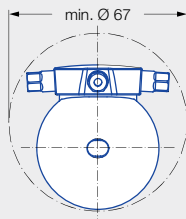

**Female thread
5TA.403.1Y.AL and 5TA.404.1Y.AL**

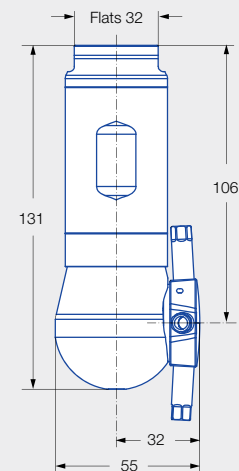
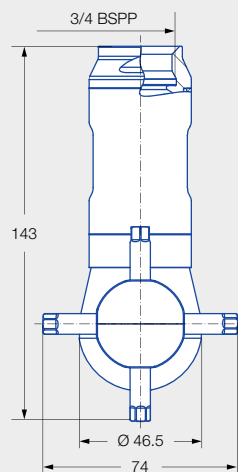
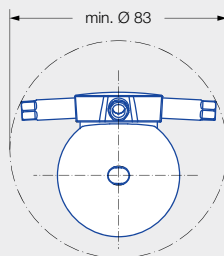

**Female thread
5TA.405.1Y.AL**





Max. tank diameter [m]	0	3	6	9	12	15	18	21	24	27
-------------------------------	---	---	---	---	----	----	----	----	----	----

Cleaning efficiency class
5

Max. temperature
95°C

Installation
Operation in every direction is possible

Bearing
Ball bearing

Material
Stainless steel 316L, stainless steel 632, PTFE, PEEK, zirconium oxide, EPDM

Recommended operating pressure
5 bar

Filtration
Line strainer with a mesh size of 0.2 mm/80 mesh

Rotation monitoring
Sensor compatible, for information: See Page 221

Weight
0.9 kg

www.lechler.com/intensecleanhygienic5ta
Or scan the QR code.



Spray angle	Ordering no.	Narrowest free cross section Ø [mm]	Number, Ø Nozzles [mm]	V̇ water [l/min]				Max. tank diameter [m]
	Type			p [bar] (p _{max} = 12 bar)				
				2.0	5.0	10.0	at 40 psi [US gal/min]	
	5TA.403.1Y.AL	1.5	4 × 3.0	24	39	55	8	12.0
	5TA.404.1Y.AL	1.5	4 × 4.0	35	56	79	11	12.5
	5TA.405.1Y.AL	1.5	4 × 5.0	50	79	111	16	13.0

NPT thread and slip-on connection available on request.

The maximum tank diameter applies to the recommended operating pressure and is meant as a recommendation only. The cleaning result is also affected by the type of soiling.

High impact cleaner IntenseClean Hygienic Series 5TB



Features:

- Extremely high degree of effectiveness due to particularly powerful solid stream nozzles
- High level of efficiency due to gear-controlled rotation
- Proven in the pharmaceutical and food and beverage industry
- Suitable for pressure levels up to 25 bar
- High surface quality



Series 5TB



ATEX version available on request

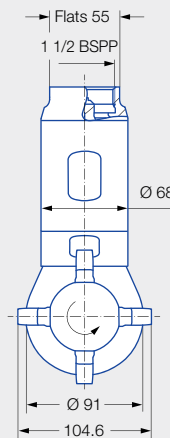
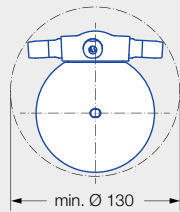

Female thread

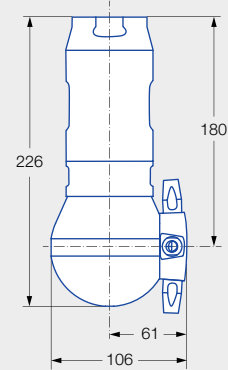

Max. tank diameter [m]	0	3	6	9	12	15	18	21	24	27
-------------------------------	---	---	---	---	----	----	----	----	----	----



Cleaning efficiency class
5



Max. temperature
95°C



Installation
Operation in every direction is possible



Bearing
Ball bearing



Material
Stainless steel 316L, stainless steel 632, PTFE, PEEK, zirconium oxide, EPDM



Recommended operating pressure
5 bar



Filtration
Line strainer with a mesh size of 0.2 mm/80 mesh



Rotation monitoring
Sensor compatible, for information: See Page 221



Weight
4.0 kg

Function video

www.lechler.com/intensecleanhygienic5tb

Or scan the QR code.



Spray angle	Ordering no. Type	Narrowest free cross section Ø [mm]	Number, Ø Nozzles [mm]	V water [l/min]				Max. tank diameter [m]
				p [bar] (p _{max} = 15 bar)				
				2.0	5.0	10.0	at 40 psi [US gal/min]	
360° 	5TB.406.1Y.AS	6.0	4 x 6.0	107	169	239	33	14.0
	5TB.407.1Y.AS	6.0	4 x 7.0	132	209	296	41	14.0
	5TB.408.1Y.AS	6.0	4 x 8.0	150	238	336	47	15.0

NPT thread available on request.

The maximum tank diameter applies to the recommended operating pressure and is meant as a recommendation only. The cleaning result is also affected by the type of soiling.

High impact cleaner IntenseClean Series 5TM

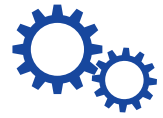

Features:

- Very robust design
- High degree of effectiveness due to particularly powerful solid stream nozzles
- High level of efficiency due to gear-controlled rotation
- Proven in the petrochemical industry



ATEX version available on request

Series 5TM

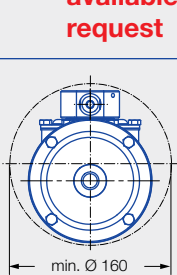

5TM.2xx.1Y.AS
(2 nozzles)

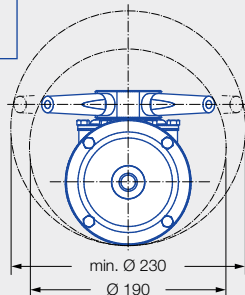

5TM.4xx.1Y.AS
(4 nozzles)

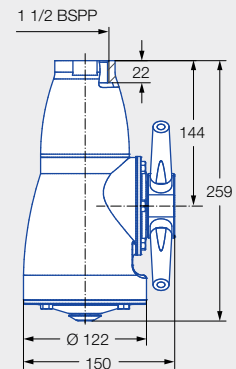
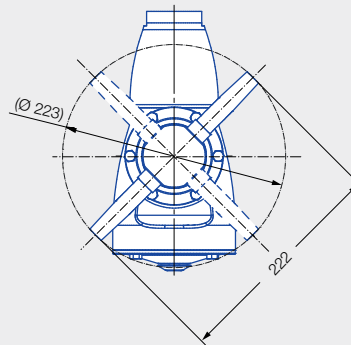

Female thread

Max. tank diameter [m]	0	3	6	9	12	15	18	21	24	27
-------------------------------	---	---	---	---	----	----	----	----	----	----



Cleaning efficiency class
5



Max. temperature
95°C



Installation
Operation in every direction is possible



Bearing
Ball bearing



Material
Stainless steel 316L, stainless steel 304, stainless steel 302, PTFE, PEEK



Recommended operating pressure
5 bar



Filtration
Line strainer with a mesh size of 0.2 mm/80 mesh



Rotation monitoring
Sensor compatible, for information: See Page 221



Weight
7.5 kg

Function video

www.lechler.com/intenseclean

Or scan the QR code.



Spray angle	Ordering no. Type	Narrowest free cross section Ø [mm]	Number, Ø Nozzles [mm]	V̇ water [l/min]					Max. tank diameter [m]
				p [bar] (p _{max} = 7 bar)					
				2.0	3.0	5.0	7.0	at 40 psi [US gal/min]	
 360°	5TM.208.1Y.AS	8.0	2 × 8.0	125	153	198	234	39	24.0
	5TM.210.1Y.AS	10.0	2 × 10.0	160	196	253	299	50	24.0
	5TM.406.1Y.AS	6.0	4 × 6.0	140	171	221	261	43	18.0
	5TM.407.1Y.AS	7.0	4 × 7.0	170	208	269	318	53	20.0
	5TM.408.1Y.AS	8.0	4 × 8.0	200	245	316	374	62	22.0
	5TM.410.1Y.AS	10.0	4 × 10.0	260	318	411	486	81	23.0

NPT thread available on request.

The maximum tank diameter applies to the recommended operating pressure and is meant as a recommendation only. The cleaning result is also affected by the type of soiling.

Rotation monitoring sensor



Features:

Cleaning procedures can be monitored easily and reliably with the Lechler rotation monitoring sensor. The sensor records the quantity of liquid flowing past the sensor tip. With the aid of software¹, the sensor function can be specifically adjusted to the tank size, pressure and nozzle.

Electrical data:

- Supply voltage:
 $U_b = 24\text{ V} \pm 20\%$
 (18 to 32 VDC)
- Power requirements:
 $< 20\text{ mA}$
- Output signal:
 PNP, 50 mA, short circuit protected, active

Operating conditions:

- Ambient temperature:
 -10 °C to $+60\text{ °C}$
- Process temperature:
 0 °C to $+100\text{ °C}$

Materials:

- Socket (1/2 BSPP):
 Stainless steel 316L
- Probe tip: PEEK
- Housing: Stainless steel 303

Operating principle:

- Capacitive

Advantages:

- Reliable recognition of any faults during the cleaning cycle
- The process connection of the sensor is in compliance with the hygiene guidelines of EHEDG
- Simple operation
- Can be connected to a PLC
- Only needs to be set up once using the software provided
- Can be specifically adapted to each cleaning task

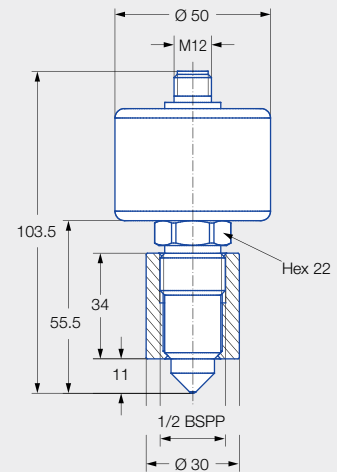

Rotation monitoring sensor, incl. weld-in sleeve



Cable set for commissioning



Mains adapter



USB adapter with cable



Programming adapter Y-piece



Weld-in mandrel

Ordering data	Ordering no.
Rotation monitoring sensor, incl. weld-in sleeve	050.040.00.00.00
Cable set for commissioning	050.040.00.00.01

¹ Software download (free): www.lechler.com/software/rotationcontrolsystem



NOZZLE-VALVE COMBINATIONS

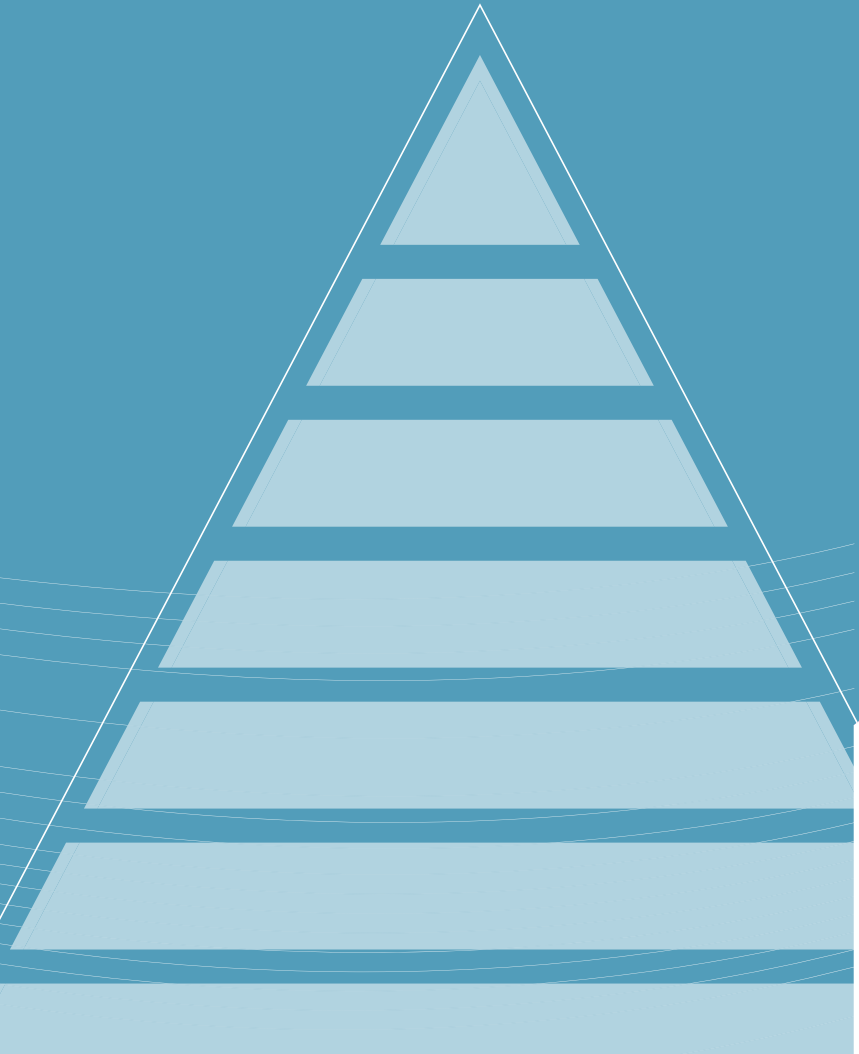
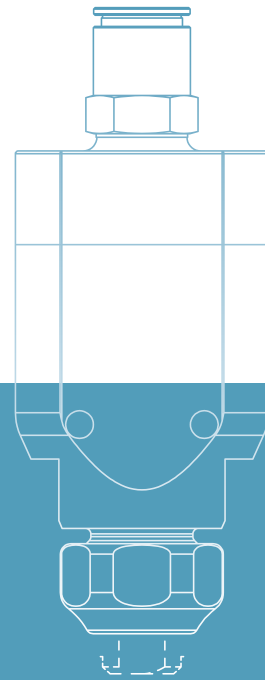

NOZZLE-VALVE COMBINATIONS

VarioSpray SYSTEMS



Innovative and flexible spraying solutions opens up for new application areas.

Faster, precisely, more sustainable: The demand for more efficient production processes is increasing in almost every industry. Even already extremely efficient spraying technology processes are affected – particularly when spraying very small liquid volumes. Pneumatic systems are often used here, as very small flow rates can be achieved by using compressed air. However, the control and installation activities are extremely complex. Additionally, the use of air can have an unfavourable effect on operating costs. Aerosols may also be formed and liquid is lost due to the rebound effect. With the VarioSpray HP and VarioSpray II hydraulic pulse-width-modulated nozzle-valve systems, Lechler offers two alternatives that are as versatile as they are reliable.

With hydraulic nozzle systems, the narrowest cross section of the spray nozzle determines the liquid flow rate. Due to economical and production-related reasons, the narrowest cross section can't be randomly minimized. Instead, we use flexible timing of the spray duration to achieve minimal flow rates – without the need for an expensive and complex pneumatic atomizing system. In addition to the VarioSpray HP and

VarioSpray II nozzle-valve systems, a control unit is also required to permit simple modification of the pulse-width and cycle frequency.

Applications

- Oil application for applying seasoning
- Web humidification
- Application of separating agent
- Humidification
- Coating
- Anti-scuffing

Your advantages

- Simple adjustment of the pulse-width and the cycle frequency
- Modular design and modular system
- Start/Stop signal (e.g. via light barrier)
- Individual valve control for VarioSpray HP
- Rinsing function



Good to know

Detailed information can be found in our brochure "VarioSpray" as well as at www.lechler.com/de-en/variospray.

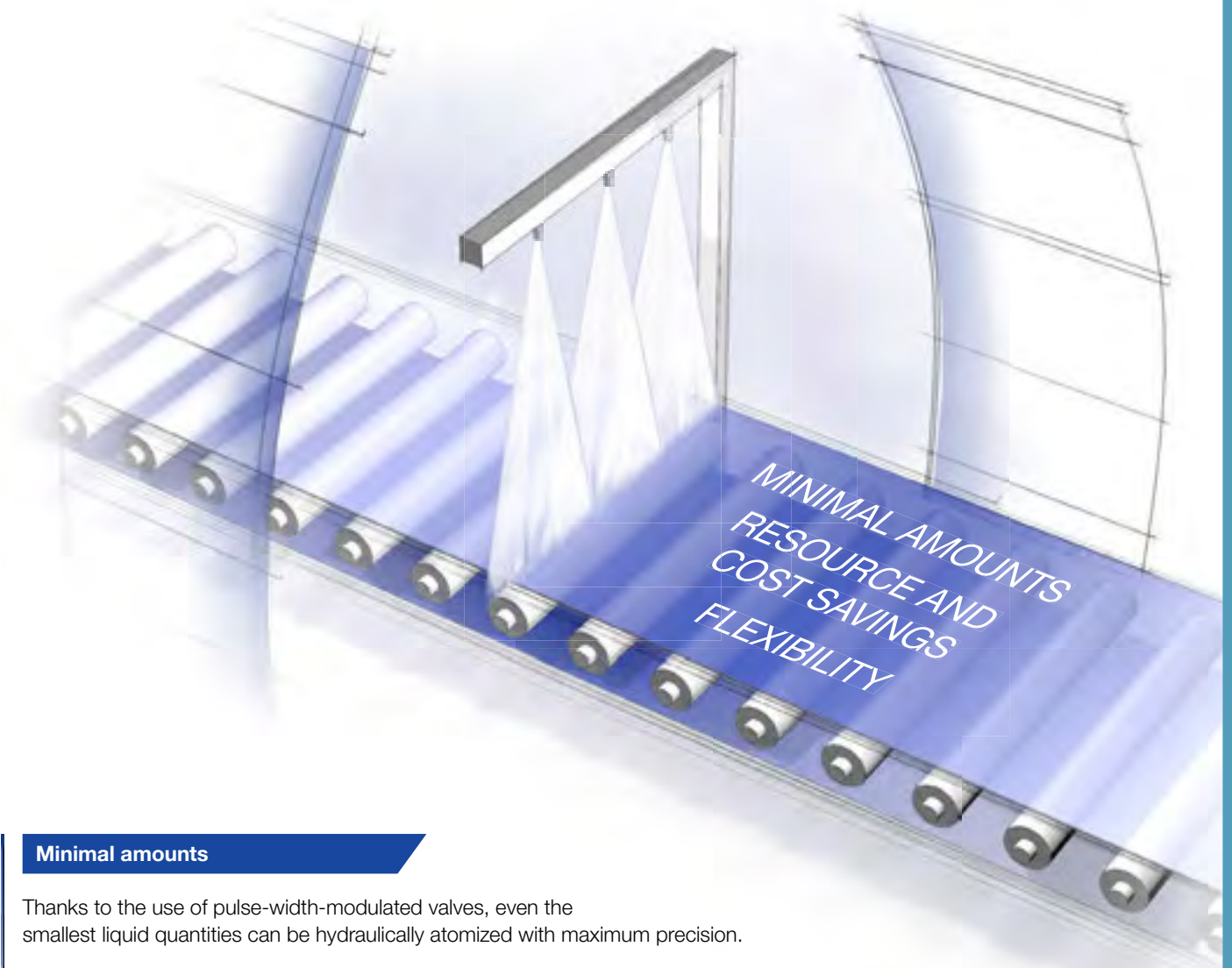

Minimal amounts

Thanks to the use of pulse-width-modulated valves, even the smallest liquid quantities can be hydraulically atomized with maximum precision.

This control method permits:

- Flexible and immediate response to changed ambient parameters (e.g. belt speed)
- Uniform jet and spray quality
- Further application benefits due to a significantly increased turn-down ratio

Resource and cost savings

The aerosol-free atomization of smallest liquid volumes offers specific benefits for spray nozzle operation. The fact that no atomizing air is used means a huge reduction in rebound effects.

The following costs are reduced as a result:

- Equipment cleaning
- Operating costs of extraction systems
- Liquid losses because the liquid being atomized is applied to the product in a more targeted manner

Flexibility

The Lechler VarioSpray system is completely modular, allowing it to be adapted to individual requirements as flexibly as possible.

The result is a perfectly coordinated product portfolio including:

- Optimum valve control due to perfectly matched electronic components
- Modular spray bars
- Various predefined Lechler control concepts
- Individual advice from our sales staff

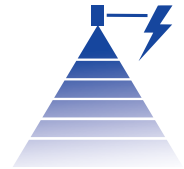

What is pulse-width modulation?

Pulse-width modulation refers to the variation of the ON time t_{on} / OFF time t_{off} of a square-wave signal when the frequency f remains constant. Here, the frequency f corresponds to the reciprocal value of the period duration T .

The ratio of the ON time t_{on} to the period duration T is referred to as the pulse-width ratio (DC = duty cycle). The pulse-width ratio determines the flow rate. The valve is open during the ON time t_{on} . The shorter the DC, the less the flow rate. Depending on the frequency selected, the pulsation is barely visible to the human eye.

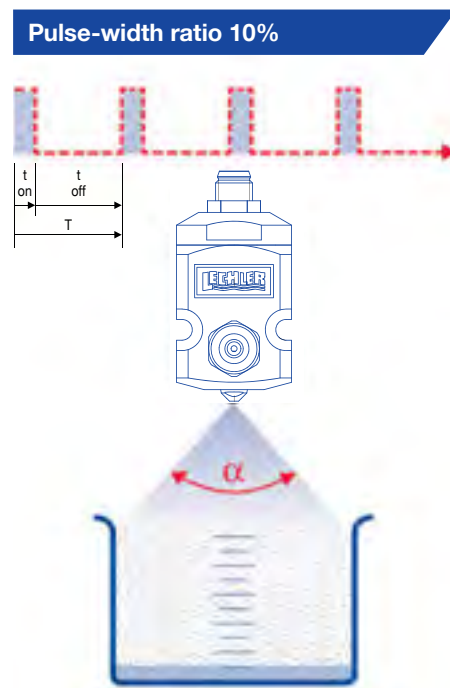
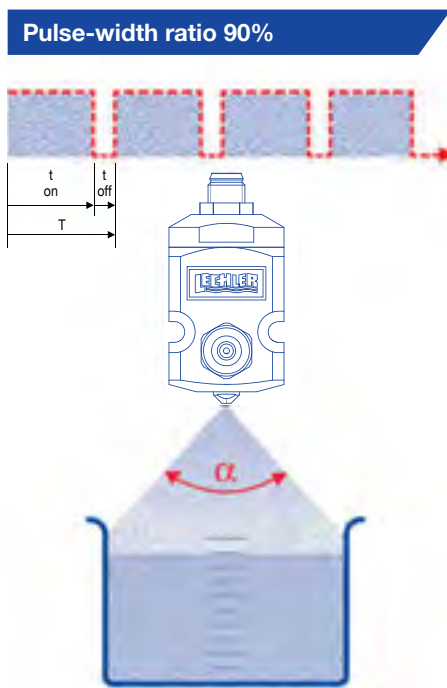

Which fluids can be sprayed?

The two innovative Lechler products VarioSpray HP and VarioSpray II can be used to precisely spray a wide range of different liquids. The two nozzle-valve systems are individually designed to optimally perform these tasks.

VarioSpray HP was developed to permit flexible spraying of a wide variety of liquids. Even high-viscosity media (up to 75 mPas, depending on the liquid density) can be easily atomized.

VarioSpray II is ideal for applying small volumes of low-viscosity, easily atomized liquids.

Sprayable liquids

VarioSpray HP	VarioSpray II
Water	
Low-viscosity separating agent	
Disinfectant	
Oils	–
Fats	–
Emulsions	–
Liquid egg	–
Milk	–
Sugar solutions	–
etc.	–

COMPARISON

VarioSpray HP – VarioSpray II



VarioSpray HP

High Performance

Flow rate: Up to 1,000 ml/min at 3 bar¹

For high viscosity media up to 75 mPa·s

Liquid supply at the rear

Flow-optimised liquid supply

Simple nozzle changeover

Turn-down ratio up to 29 : 1

Filter optionally available

Push-in connection for
8 mm hose diameter

Voltage 12 V DC/24 V DC for Peak & Hold
activation

Electrical connection via M8 slip-on connection

Control via colour touch panel

Two control unit versions:

- SMART (max. 8 valves)
- FLEX (max. 16 valves)

Individual valve control (FLEX)

Frequencies: 10/20/30/40/50/75/100/200 Hz

VarioSpray II

Flow rate: Up to 140 ml/min at 3 bar¹

For low viscosity media up to 15 mPa·s

Liquid supply at the side

Low liquid volume in the valve

Very small design

Turn-down ratio up to 11 : 1

Integrated last-chance filter

Push-on connection
for 6 × 1 mm hose diameter

Voltage 24 V DC

M8 slip-on connection

Compact control unit

Simple operation
(max. 8 valves)

All valves activated simultaneously

Frequencies: 25/50/75/100 Hz

¹ Nominal flow rate without nozzle.

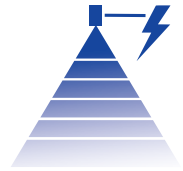

VarioSpray HP

High Performance

The HP series can be used to atomise a wide variety of liquids. All parts that come into contact with liquids are made of stainless steel, thereby complying with Directives EC 1935/2004 and FDA regulations.

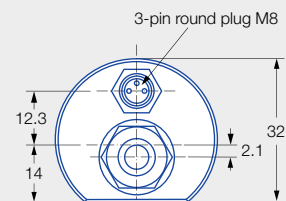
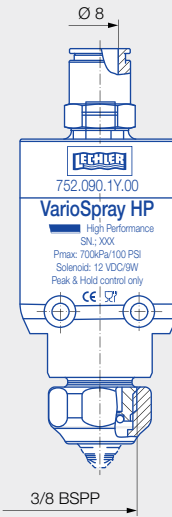
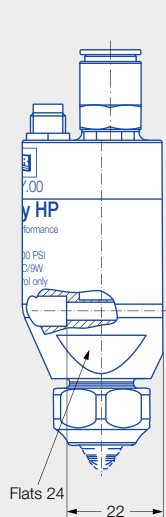
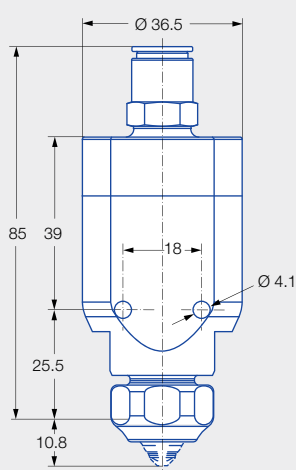

Components and combination options



Individual valve



Combination example of the components

Good to know

Detailed information on VarioSpray HP along with the order numbers of the system components can be found in our brochure "VarioSpray". A PDF is available for download at www.lechler.com/de-en/variospray

VarioSpray II

Nozzle valves of the VarioSpray II series can efficiently atomise the smallest liquid volumes. Their size makes these valves ideal for use in tight spaces. The VarioSpray II system is also available as a food grade version, thereby complying with Directives EC 1935/2004 and FDA regulations.

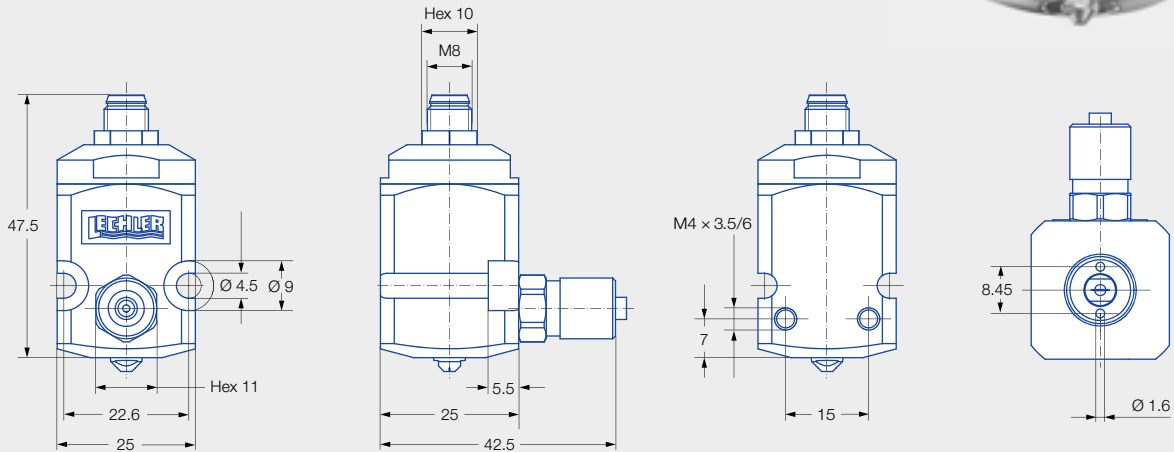

Components and combination options



Individual valve



Assembly tool

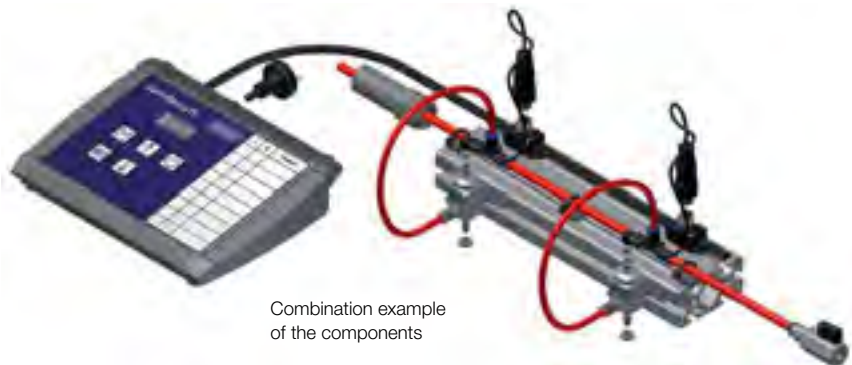

Combination example of the components

Good to know

Detailed information on VarioSpray II along with the order numbers of the system components can be found in our brochure "VarioSpray". A PDF is available for download at www.lechler.com/de-en/variospray

NOZZLE VALVE SERIES 166H

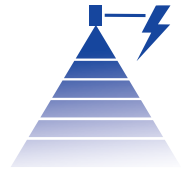

The stainless steel housing in combination with a solenoid valve offers the possibility to clock the spray application flexibly.

Applications:

- Cleaning
- Surface treatment
- Humidification
- Lubrication processes

Scope of supply:

- Nozzle valve with housing, retaining nut and a 5 m long plugged power cable
- Nozzle must be ordered separately



Series 166H

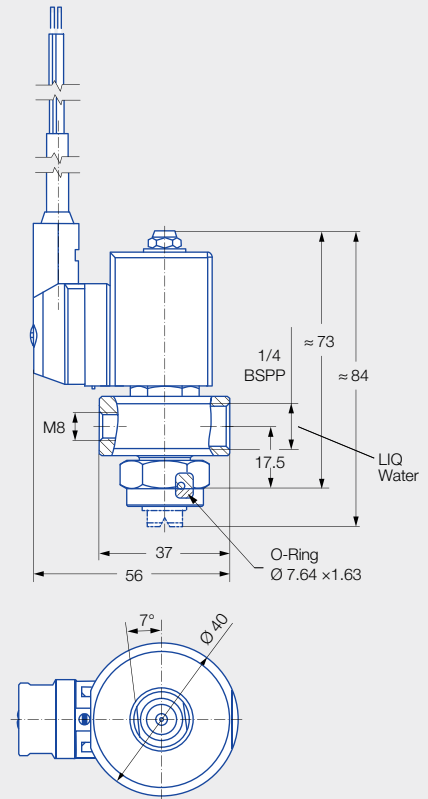

Material:

Housing: Stainless steel 316L
 Inner parts: Stainless steel 316L,
 stainless steel 304,
 stainless steel 434
 Gasket material: FKM
 (conforms to FDA)

Water flow rate:

Max. 6.5 l/min at 5 bar

Max. operating pressure:

10 bar

Power:

8 W

Voltage:

24 V DC

Protection class:

IP 65

Max. switching frequency:

500/min at 5 bar

	Type	Nozzle size up to	Spray character	Spray angle/Material
	652	64x	Flat fan	Page 118
	684	608	Flat fan (tongue-type nozzle)	Page 134
	468	68x	Full cone spray	Page 92
	226	285	Hollow cone	Page 67

Your advantages

- Quick and simple nozzle assembly using a retaining nut guarantees an easy nozzle changeover
- Simple spray alignment
- Flexible design that allows the use of flat fan nozzles, hollow cone nozzles and full cone nozzles
- With integrated gasket for sealing between the nozzle and the valve

Ordering no.
166.000.1Y.H1.00.0

POSITIONABLE FLAT FAN NOZZLE FOR SERIES 166H AND VarioSpray HP

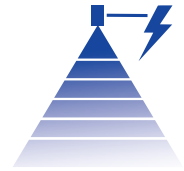

Properties:

- Outer geometry of the nozzle housing fluidically optimised for pulsed operation
- Positioning takes place via the attached dovetail
- Nozzle sizes and spray angles identical to standard nozzle series 652



Series 652.xxx.16.56

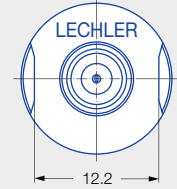
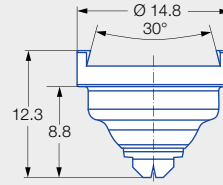

Type	Nozzle size up to	Spray character	Spray angle	Material
652.xxx.16.56	64x	Flat fan	Page 118	303 SS

Please refer to the data of series 652 on w for the nozzle size (flow rate and spray angle).

Ordering Type + Nozzle size = Ordering no.
example: 652.xxx.16.56 + 301 = 652.301.16.56



ACCESSORIES

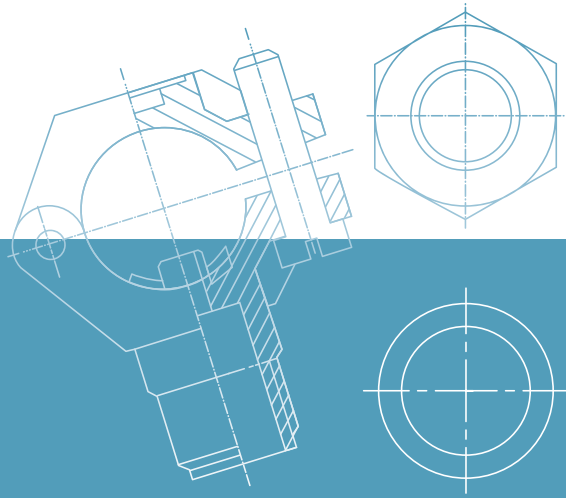

NOZZLE FASTENING ASSEMBLING OPTIONS FOR ALL PURPOSES



Assembly accessories for nozzles without thread or with female thread

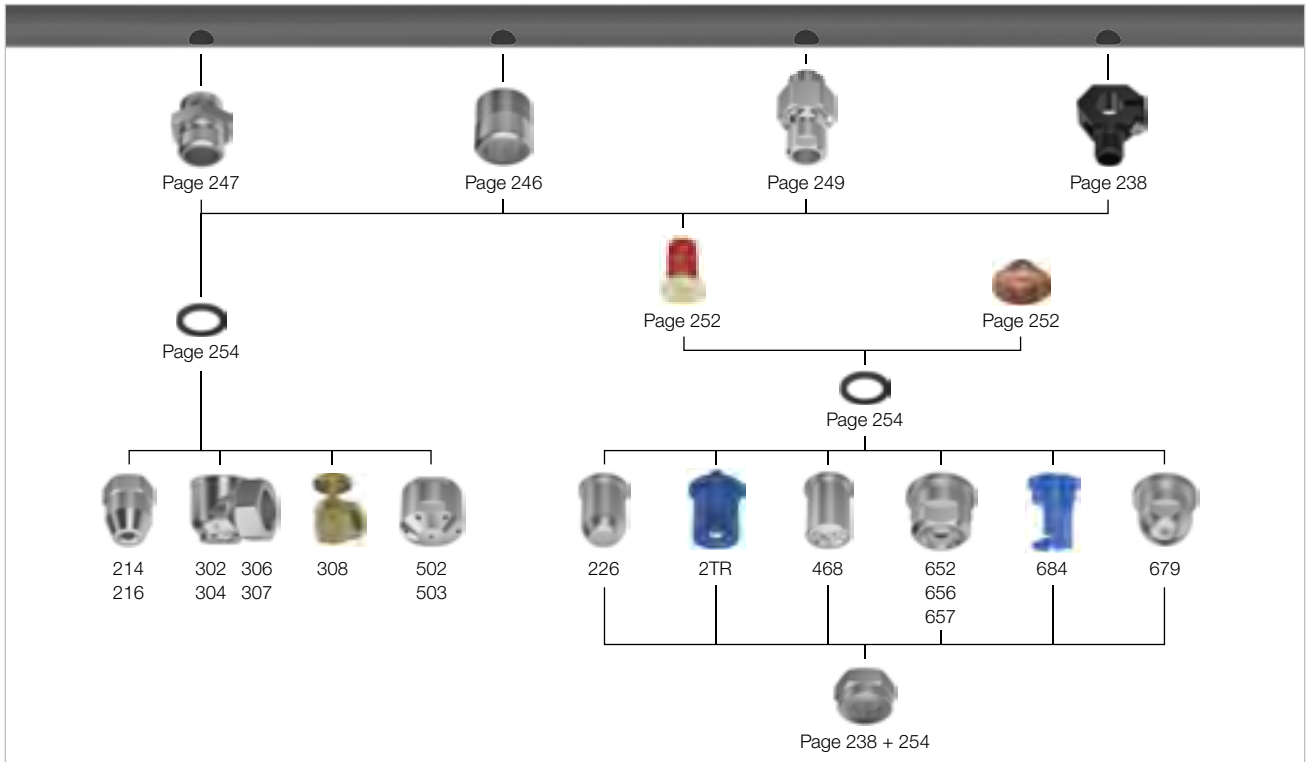

Bayonet quick-release system for nozzles without thread or with bayonet connection

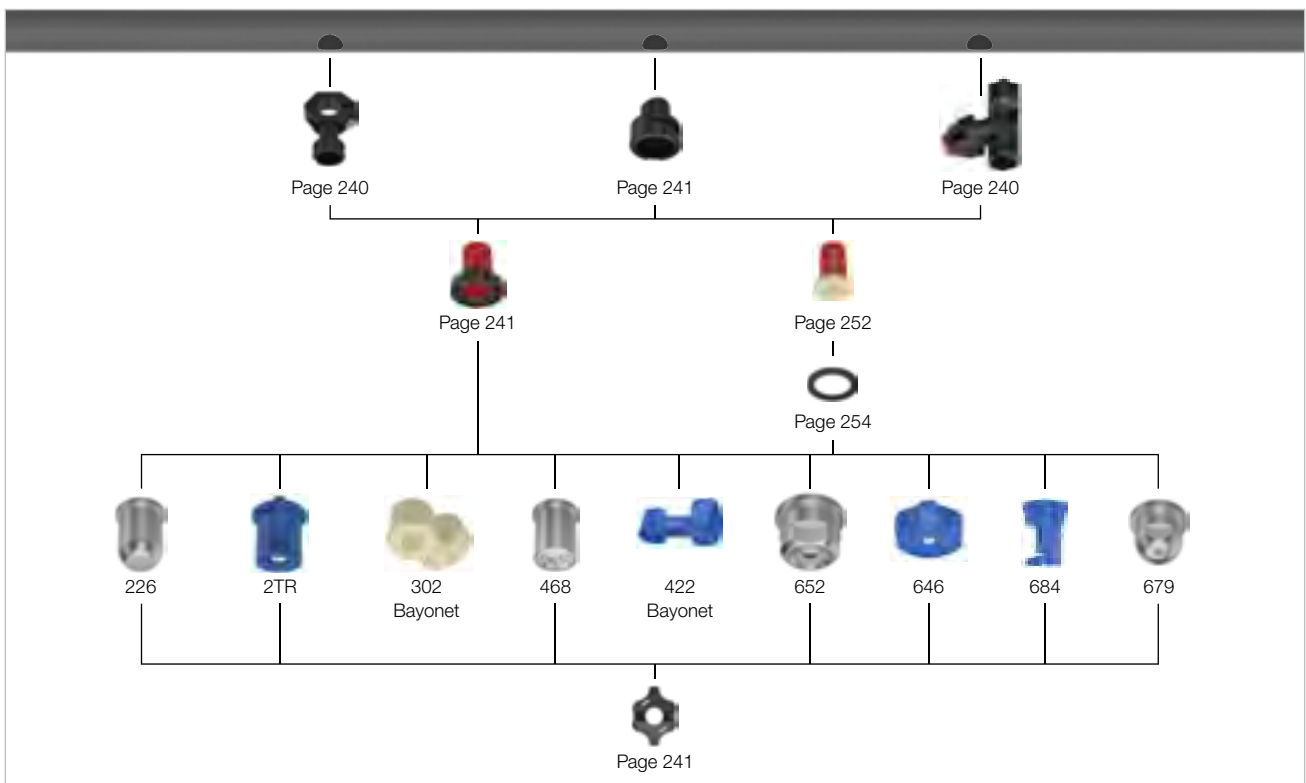

Bayonet quick-release system with ball joint for nozzles with male thread

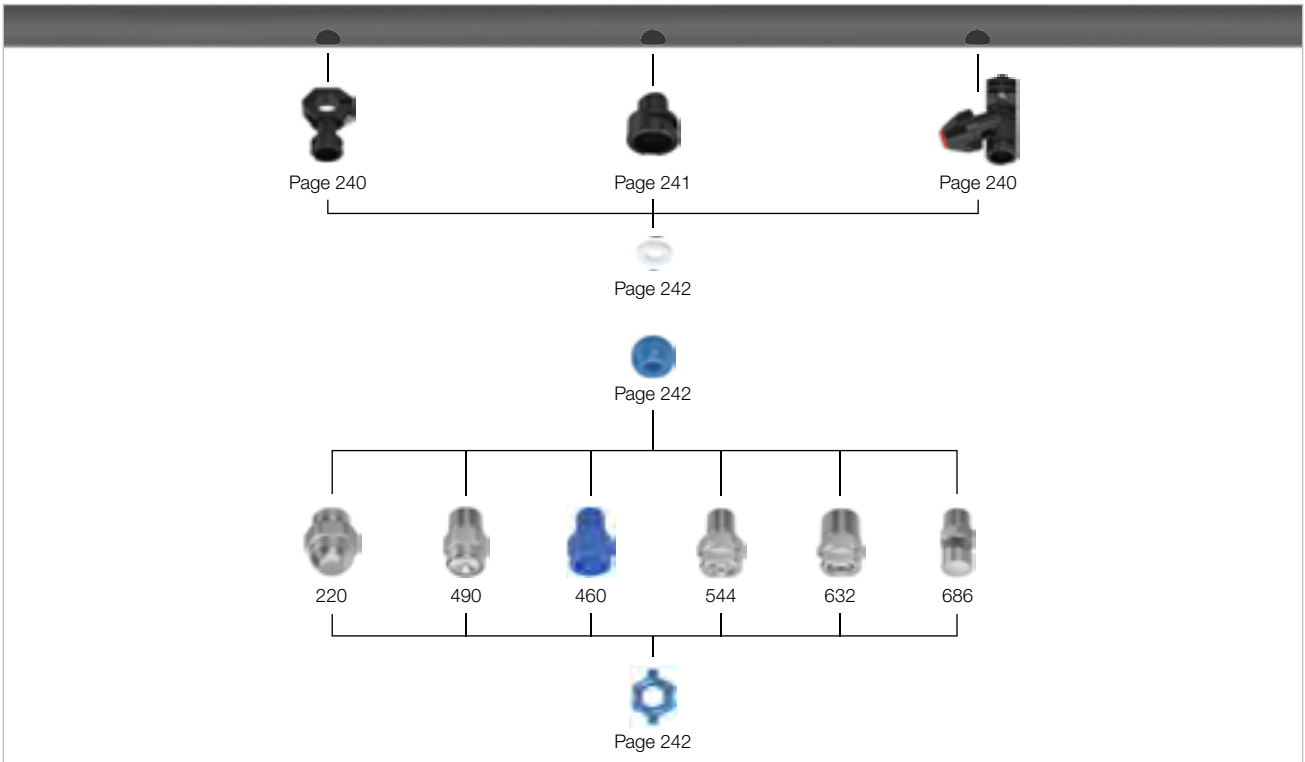

Assembly accessories for nozzles with male thread

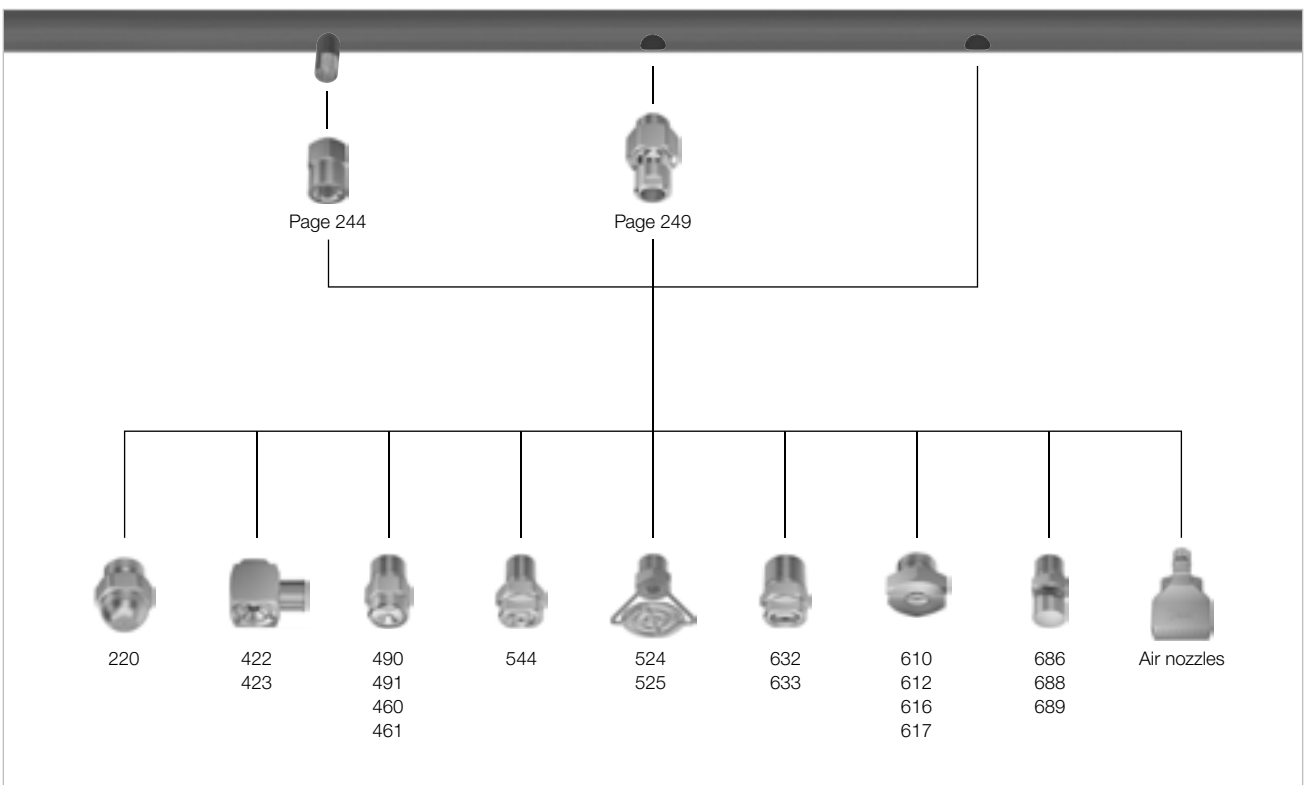



Assembly accessories for nozzles with dovetail version

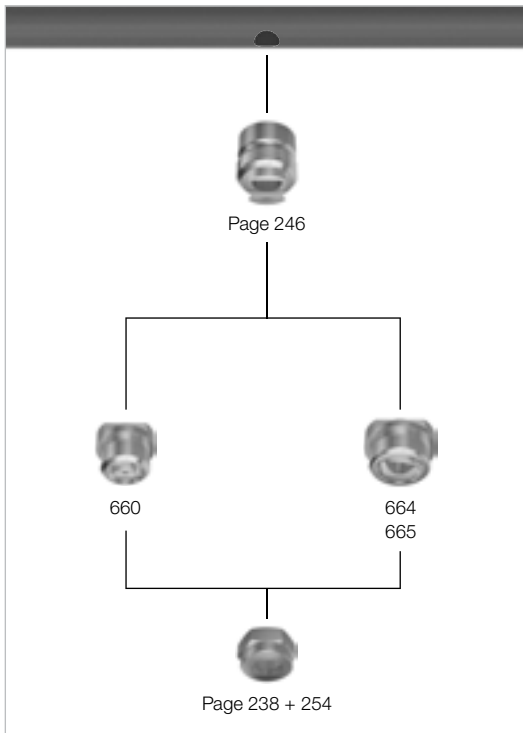

Assembly accessories for nozzles with integrated ball joint

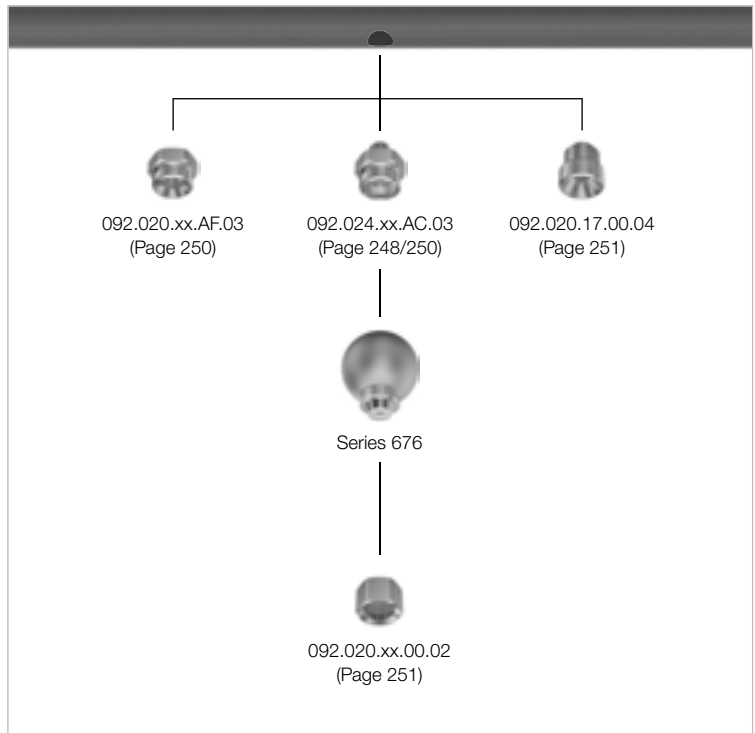

TWISTLOC quick-release system for nozzles without thread

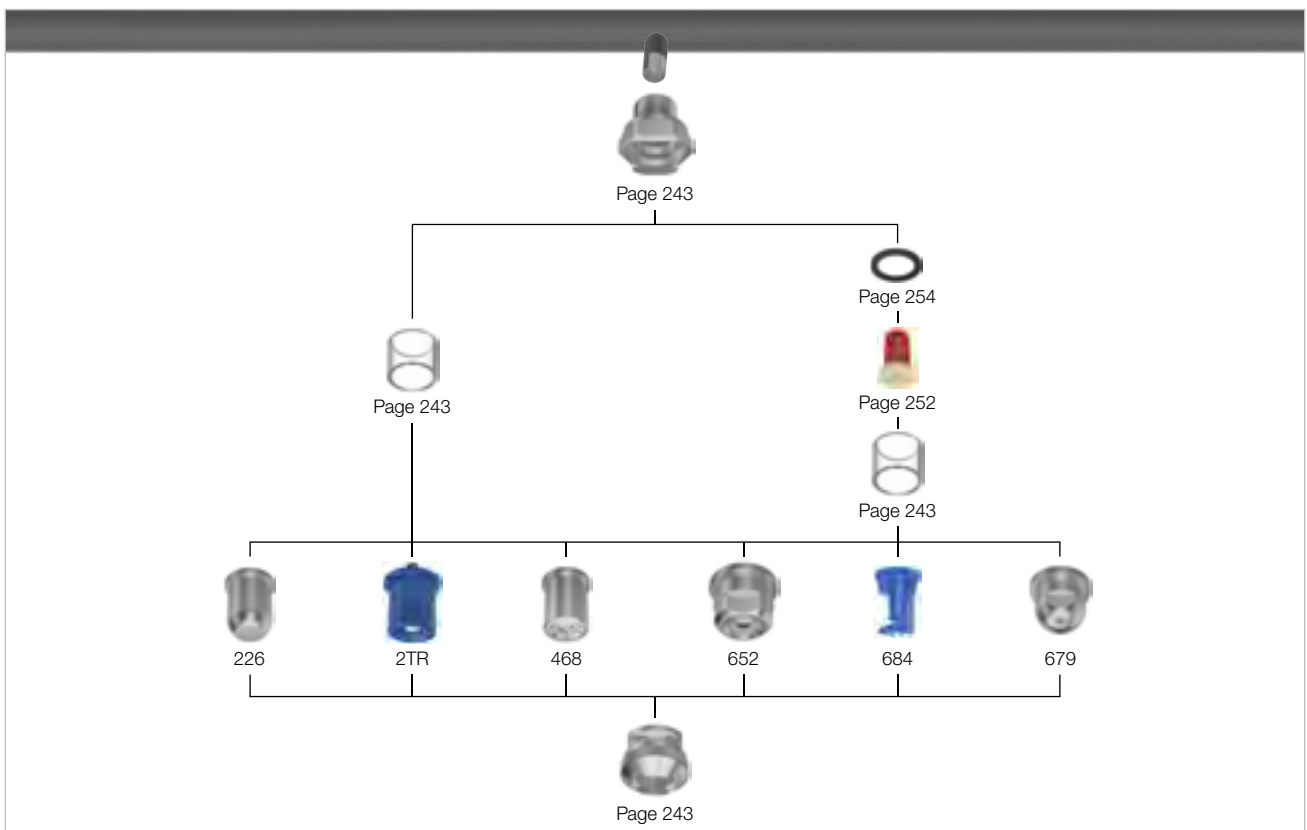

MEMOSPRAY/Easy-Clip combination options

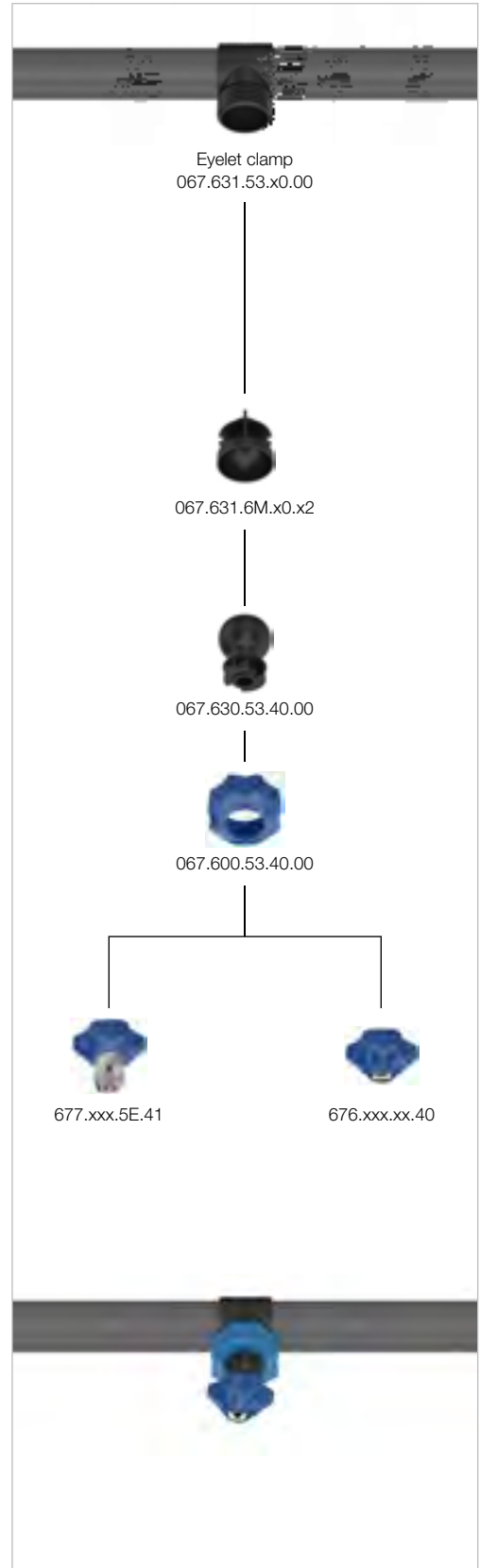
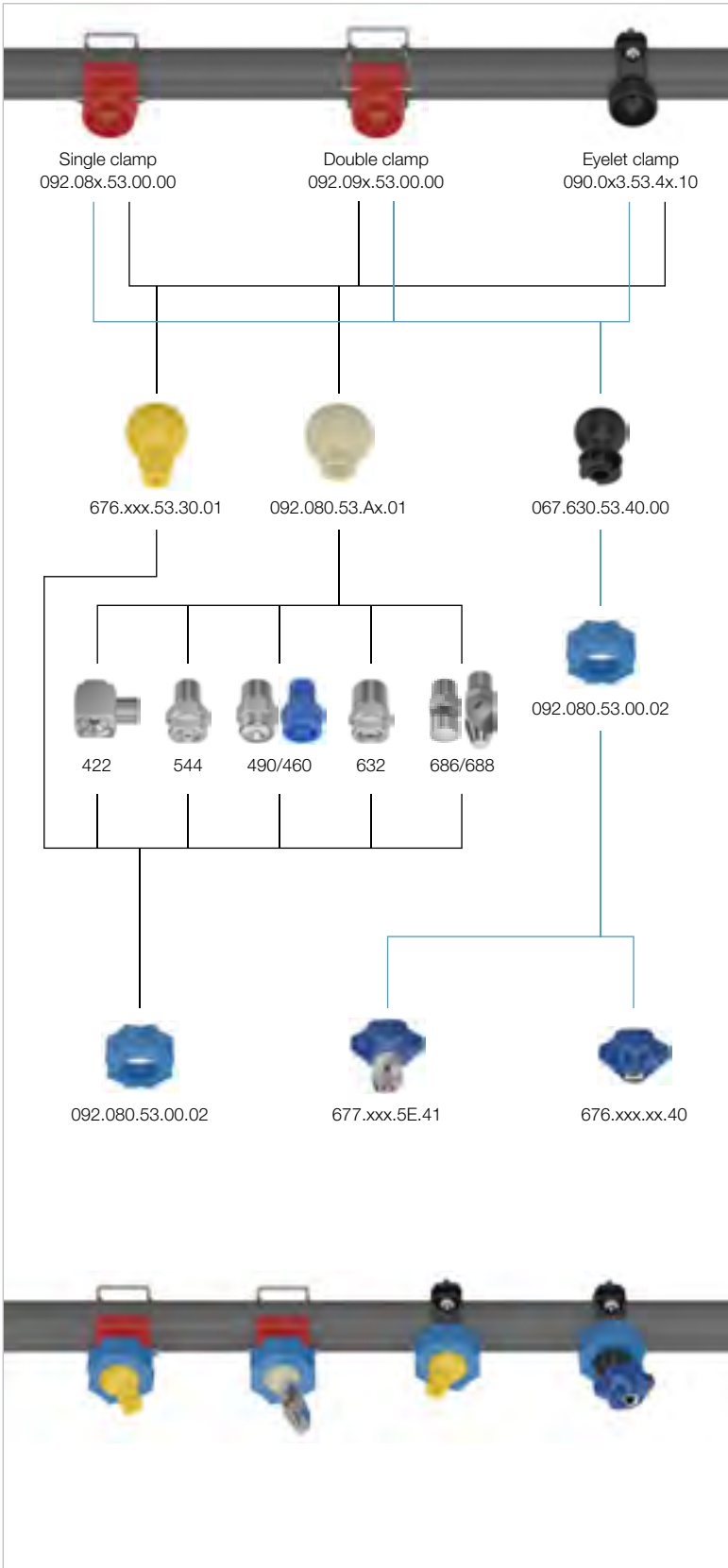

Eyelet clamps with male thread

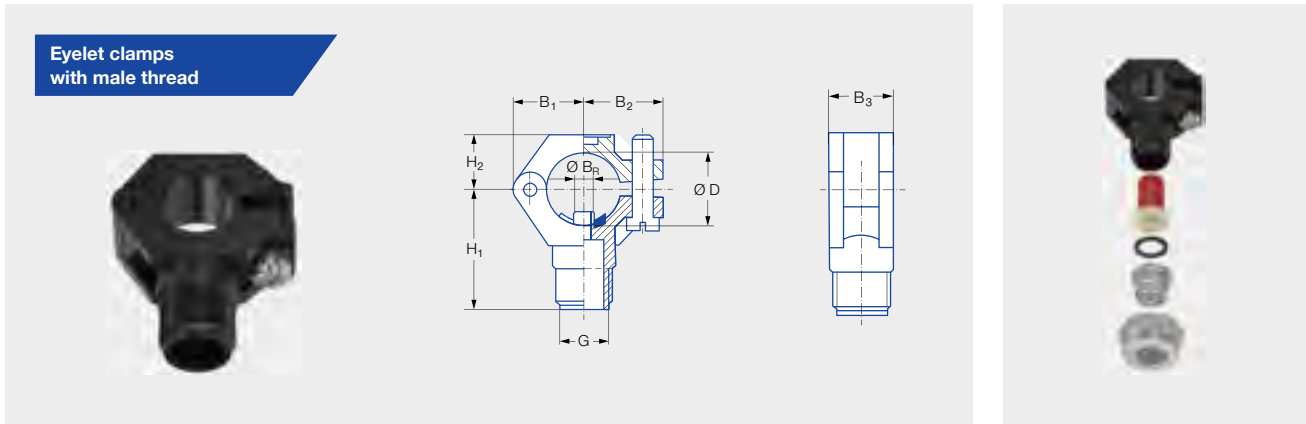

Series	Ordering no.			Screw (material)	G BSPP	Pipe Ø	Dimensions [mm]							Weight [g] (polyamide)		
	Type	Mat. no.					B ₁	B ₂	B ₃	H ₁	H ₂	Ø B _R ¹	Ø B ²		Ø D	
		51 Black	53 White													5E Blue
226/2TR/ 216/302/ 308/350/468/ 652/679/684	090.053	●	●	●	Stainless steel 304	3/8	3/8"	19.0	22.0	18.5	34.5	14.5	6.0	6.2-6.4	16.5-18.0	20.0
	090.003	●	●	●		3/8	1/2"	21.2	23.8	18.5	36.5	16.5	6.0	6.2-6.4	20.0-22.0	20.0
	090.013	●	●	●		3/8	3/4"	24.5	26.5	22.0	39.5	17.5	7.6	7.8-8.0	25.0-27.5	25.0
	090.023	●	●	●		3/8	1"	30.0	31.0	22.0	44.0	21.0	10.6	10.8-11.0	32.0-34.5	32.0
	090.033	●	●	●		3/8	1 1/4"	34.0	35.5	25.0	48.0	25.0	12.6	12.8-13.0	40.0-43.0	38.0

¹ Ø B_R = spigot diameter.

² Ø B = recommended bore diameter.



Series	Ordering no.					G BSPP	Dimensions [mm]				Weight [g]	
	Type	Mat. no.					H ₁	H ₂	Ø D	Hex		
		16	17 ¹	30	56 Black							5E Blue
226/2TR/ 468/548/ 652/660/679/ 684	065.200	●	●	●		3/8	13.0	10.0	12.8	22	25.0 (Brass)	
	065.200				●		●	14.5	11.5	12.8	22	5.0 (PVDF)

¹ We reserve the right to supply material 316Ti or 316L under material no. 17.

Ordering Type + Material no. = Ordering no.
example: 090.053 + 51 = 090.053.51

Strainers and ball-type non-return valves can be found on Page 252/253.

Eyelet clamps with female thread



Eyelet clamps with female thread

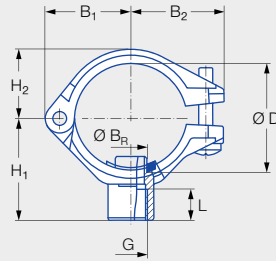

For all nozzles with	Ordering no.						Screw (material)	Pipe Ø	Dimensions [mm]							Weight [g] (polyamide)		
	Type	Mat. no.			Code				B ₁	B ₂	B ₃	H ₁	H ₂	L	Ø B _R ¹		Ø B ²	Ø D
		51 Black	53 White	5E Blue	1/8 BSPP	1/4 BSPP												
Male thread 1/8 BSPP 1/4 BSPP	090.100	●	●	●	AB	AD	Stainless steel 316	3/8"	20.0	23.0	18.5	28.0	14.0	12.0	6.0	6.2-6.4	16.5-18.0	18.0
	090.110	●	●	●	AB	AD		1/2"	22.0	25.0	18.5	31.0	16.0	12.0	6.0	6.2-6.4	20.0-22.0	19.0
	090.120	●	●	●	AB	AD		3/4"	25.0	28.0	22.0	33.0	19.0	12.0	7.6	7.8-8.0	25.0-27.5	24.0
	090.130	●	●	●	AB	AD		1"	30.0	33.0	22.0	36.0	23.0	12.0	10.6	10.8-11.0	32.0-34.5	34.0
	090.140	●	●	●	AB	AD		1 1/4"	34.0	37.0	25.0	40.0	28.0	12.0	12.6	12.8-13.0	40.0-43.0	39.0

¹ Ø B_R = spigot diameter.
² Ø B = recommended bore diameter.

Ordering Type + Material no. + Code = Ordering no.
 example: 090.100 + 51 + AB = 090.100.51.AB

Eyelet clamps with bayonet connection

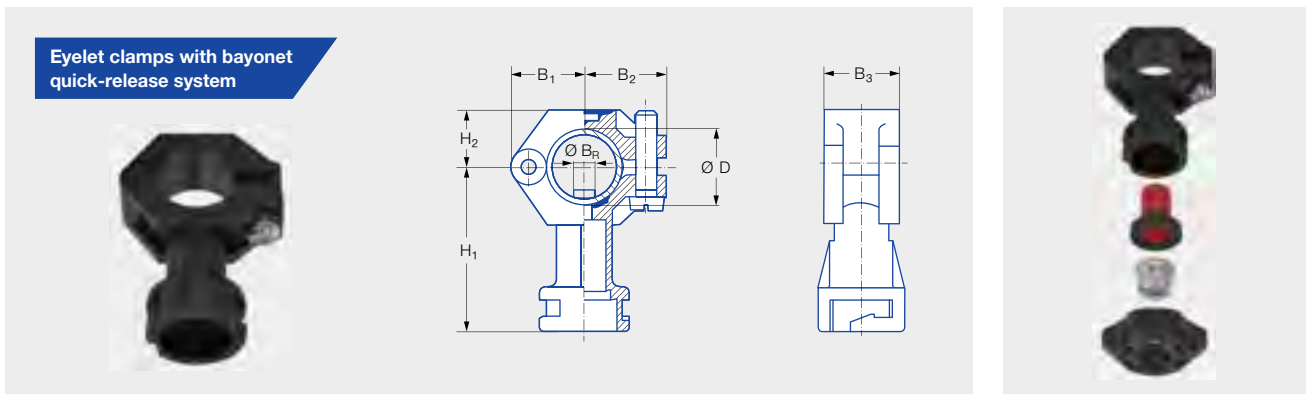

Series	Ordering no.				Screw (material)	Pipe Ø	Dimensions [mm]							Weight [g] (Polyamide)		
	Type	Mat. no.					Code	B ₁	B ₂	B ₃	H ₁	H ₂	Ø B _R ¹		Ø B ²	Ø D
		51 Black Polyamide	53 White Polypropylene	5E Blue PVDF												
226/2TR/ 302 bayonet/ 422 bayonet/ 468/652/646/ 684/679	090.003	●	●	●	KA	Stainless steel 304	1/2"	21.2	23.8	18.5	49.5	16.5	6.0	6.2–6.4	20.0–22.0	22.0
	090.013	●	●	●	KA		3/4"	24.5	26.5	22.0	52.5	17.5	7.6	7.8–8.0	25.0–27.5	26.0
	090.023	●	●	●	KA		1"	30.0	31.0	22.0	57.0	21.0	10.6	10.8–11.0	32.0–34.5	32.0

¹ Ø B_R = spigot diameter.

² Ø B = recommended bore diameter.

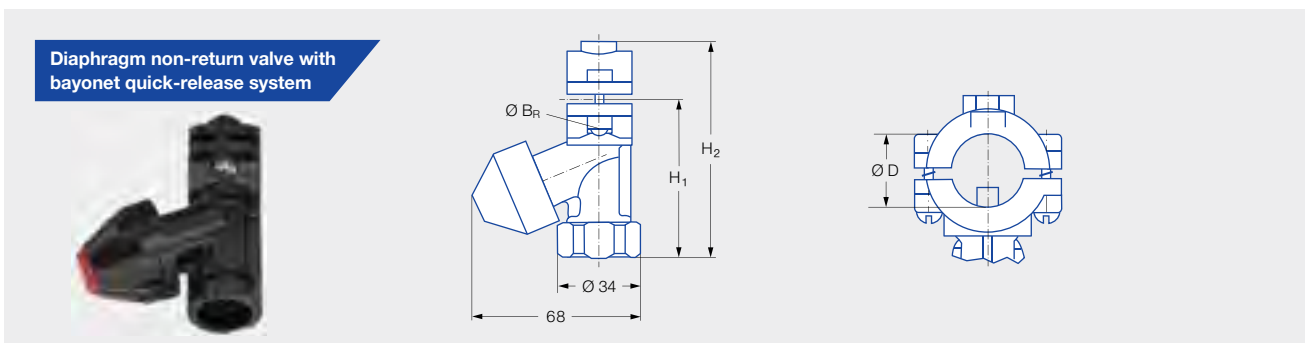

Series	Ordering no.			Screw (material)	Pipe Ø	Ø D [mm]	Pressure [bar]		Dimensions [mm]				Weight [g]	
	Type	Mat. no.					Code	Opening pressure	Closing pressure	H ₁	H ₂	Ø B _R ¹		Ø B ²
		56 Black	POM											
226/2TR/ 302 bayonet/ 422 bayonet/ 468/652/646/ 684/679	065.272	●		KH	Stainless steel 303	1/2"	20.0–22.0	0.8	0.6	59.0	84.0	6.0	6.2–6.4	48.0
	065.272	●		KL		3/4"	25.0–27.5	0.8	0.6	66.0	90.0	9.6	9.8–10.0	53.0

¹ Ø B_R = spigot diameter.

² Ø B = recommended bore diameter.

Material	Max. temperature [°C]	Max. pressure [bar]
PA, PP, PVDF, POM	65	10
PA, PP, PVDF, POM	80	8
PVDF	100	4

Notice: Please consider the material combination when using bayonet eyelet clamps with bayonet quick-release system nuts. The nuts may be difficult to turn when using different materials.

Accessories for bayonet system



Bayonet welded nipple

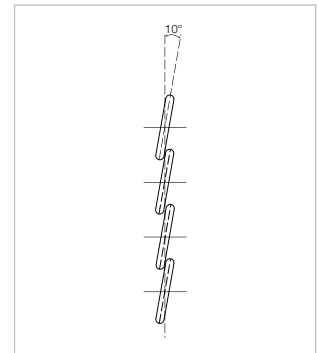
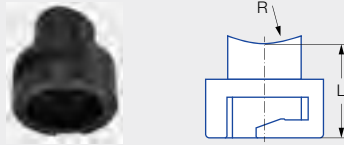

Twist angle to the right in relation to the pipe axis. Twist angle 10°. Other twist angles available on request.

Series	Ordering no.			Dimensions [mm]		Weight [g]
	Type	Mat. no.		L	R	
		50	53			
226/2TR/302 bayonet/ 422 bayonet/468/ 652/646/684/679	095.016.xx.08.05 ¹	PVC	Polypropylene	25.0	16.0	10.0

¹ Replace "xx" with the desired material no.

Strainer with gasket

Suitable for bayonet quick-release system nuts 065.202

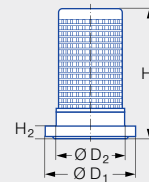

Performance size	Ordering no.		Colour	Dimensions [mm]					Weight [g]
	Type	Mat. no.		Mesh size	H ₁	H ₂	Ø D ₁	Ø D ₂	
		7J							
xxx.32x-xxx.44x	065.268	POM/Santoprene	Blue	0.25	19.20	3.00	18.00	12.00	2.00
xxx.48x-xxx.56x	065.269	POM/Santoprene	Red	0.65	19.20	3.00	18.00	12.00	2.00

Bayonet quick-release system nuts

Incl. gasket 065.242.73 (material: Rubber)

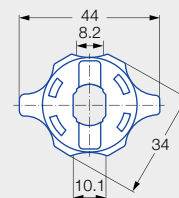

Series	Ordering no.			Colour	Weight [g]
	Type	Mat. no.			
		POM	Polypropylene		
652/679	065.202.56.00			Red	10.0
	065.202.53.00			Grey	10.0
	065.202.5E.00			Blue	10.0

Bayonet quick-release system nuts

Incl. gasket 065.242.73 (material: Rubber)

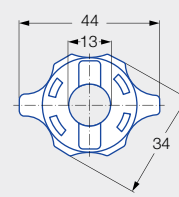

Series	Ordering no.		Colour	Weight [g]
	Type	Mat. no.		
		POM		
226/2TR/ 468/684	065.202.56.11		Black	10.0
	065.202.53.11		Grey	10.0

Notice: Please consider the material combination when using bayonet eyelet clamps with bayonet quick-release system nuts. The nuts may be difficult to turn when using different materials.



Ball joints for bayonet quick-release system

Ball joint system for nozzles with 1/8" and 1/4" male thread.

Ball joint for eyelet clamps with bayonet quick-release system

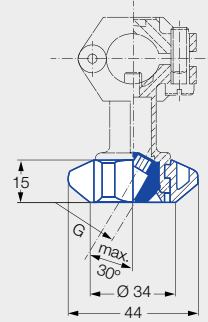

For all nozzles with 1/8" or 1/4" male thread	Ordering no.				Colour	Weight [g]
	Type	Mat. no.	Code			
		PVDF	1/8 BSPP	1/4 BSPP		
Ball joint	092.150	5E	AB	AD	Blue	5.0

Bayonet quick-release system nut for ball joint

Incl. O-ring
Ordering no. 095.015.7C.04.16.0
(material: 72 NBR 872)

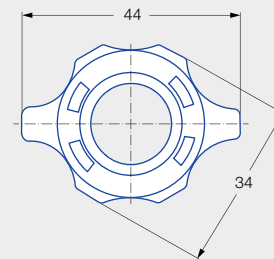

For all nozzles with 1/8" or 1/4" male thread	Ordering no.			Colour	Weight [g]
	Type	Mat. no.			
		PVDF			
Quick-release system nut	092.150.5E.00	●		Blue	28.0

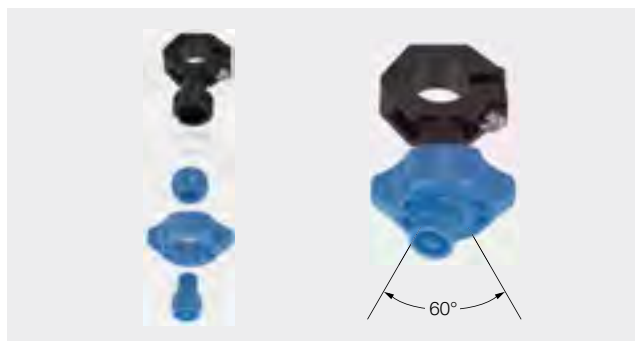

Max. temperature [°C]	Max. pressure [bar]
65	10
80	8
100	4

Ordering Type + Material no. + Code = Ordering no.
example: 092.150 + 5E + AB = 092.150.5E.AB

» TWISTLOC

Quick-change nozzle system



Lechler TWISTLOC, nozzle changing in less than no time.

Save time and money with the quick-change nozzle system.

- **Quick:**
It takes just one twist to install or remove the nozzle.
- **Easy:**
Can be installed without tools – even in difficult-to-access locations and in bad lighting conditions.
- **Safe:**
Installation errors are avoided, as the nozzles are always set to the correct direction.
- **Max. pressure:**
15 bar.



System components		Ordering no.							Inner Ø D [mm]	Weight [g]		
		Type	Mat. no.				Code					
			1C Stainless steel 304	16 Stainless steel 303	5E PVDF	7A Viton	1/4 BSPT	3/8 BSPT			Welded connec- tion	
Threaded nipple		092.102	●				CC		8.0	25.0		
		092.102	●					CE		11.6	25.0	
		092.102			●				CE		8.0	10.0
Welded nipple		092.104	●					00		11.6	45.0	
Gasket for material 304 SS and 303 SS		092.113				●				-	1.0	
Gasket for material PVDF		092.115				●					-	1.0
Gasket, incl. rubber gasket ring for use with non-return valves or strainers		092.116				●					-	2.0
Gasket, incl. rubber gasket ring for use with non-return valves or strainers, for PVDF material		092.114				●						-
Quick-release system For nozzle series 652/679		092.106	●	●							-	20.0 (stainless steel)
Quick-release system For nozzle series 226/468/684		092.108	●	●								-



Non-return valves, strainers
For installation in nipples with inner Ø 11.6 mm (see Page 252/253).

Ordering Type + Material no. + Code = Ordering no.
example: 092.102 + 16 + CC = 092.102.16.CC



Sockets

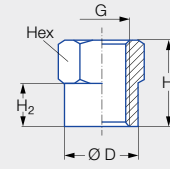

For all nozzles with	Ordering no.				G BSPP	Dimensions [mm]				Weight [g] (Brass)	
	Type	Mat. no.				H ₁	H ₂	Ø D	Hex		
		1Y	17	30							53
1/8" male thread	040.270	●		●		1/8	20.0	10.0	13.8	14	20.0
1/4" male thread	061.220	●		●		1/4	20.0	10.0	16.8	17	20.0
3/8" male thread	040.271		●	●		3/8	20.0	10.0	21.8	22	25.0
	040.271				●	3/8	20.0	11.0	25.0	22	25.0
1/2" male thread	040.272		●	●		1/2	30.0	15.0	26.5	27	70.0
3/4" male thread	061.620		●	●		3/4	40.0	20.0	31.5	32	108.0

Notice: Sockets are also suitable for welding.

Sockets with radius

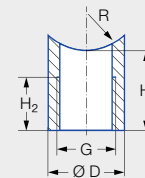

For all nozzles with	Ordering no.		G BSPP	Dimensions [mm]			Weight [g]
	Type	Mat. no.		H ₁	H ₂	Ø D	
		1Y					
1/4" male thread	040.228.1Y.yy ¹	●	1/4	18.0	12.0	17.0	16.0

¹ Replace "yy" with the desired radius R (R = 10/13/16/20/25 or 31 mm).

Ordering Type + Material no. = Ordering no.
 example: 040.270 + 1Y = 040.270.1Y

Sockets

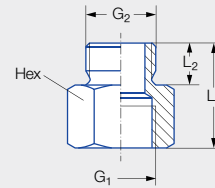

Connection components	Ordering no.			G ₁ BSPP	G ₂ BSPP	Dimensions [mm]			Weight [g] (Brass)
	Type	Mat. no.				L ₁	L ₂	Hex	
		17 Stainless steel 316Ti	30 Brass						
1/8" to 3/8"	040.211	●	●	1/8	3/8	20.0	10.0	22	40.0
1/4" to 3/8" short	065.221	●	●	1/4	3/8	23.0	10.0	22	40.0
1/4" to 3/8" long	065.228	●	●	1/4	3/8	36.0 ¹	14.0	19	45.0
3/8" to 3/8"	065.220	●	●	3/8	3/8	25.0	10.0	22	40.0
3/4" to 3/4"	065.620	●	●	3/4	3/4	35.0	14.0	32	280.0

¹ Mounting of nozzle filters and ball-type non-return valves possible (see Page 252/253).

Reduction socket

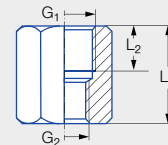
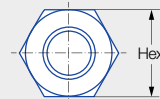

Connection components	Ordering no.			G ₁ BSPP	G ₂ BSPP	Dimensions [mm]			Weight [g]
	Type	Mat. no.				L ₁	L ₂	Hex	
		1Y Stainless steel 316L	30 Brass						
3/8" to 1/4"	095.019.30.00.23		●	3/8	1/4	26.0	12.0	22	55.0

Ordering Type + Material no. = Ordering no.
example: 040.211 + 17 = 040.211.17



Welded nipple with dovetail guide

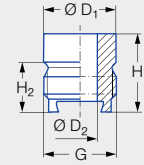

Series	Ordering no.				G BSPP	Dimensions [mm]				Weight [g]
	Type	Mat. no.				H ₁	H ₂	Ø D ₁	Ø D ₂	
		17	Stainless steel 316Ti							
660	066.011	●			3/8	18.0	11.5	16.5	8.0	21.0
664/665	066.410	●			3/4	27.0	15.5	28.0	14.0	65.0

Welded nipple

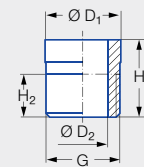

Series	Ordering no.					G BSPP	Dimensions [mm]				Weight [g] (Brass)
	Type	Mat. no.					H ₁	H ₂	Ø D ₁	Ø D ₂	
		02	17	30	53						
226/216/2TR/302/308/350/ 468/652/684/548/679	065.210	●	●	●	●	3/8	18.0	10.0	17.2	11.6	20.0
306/307/502/ 503/656/657	065.610	●	●		●	3/4	27.0	14.0	28.0	18.0	61.0

Ordering Type + Material no. = Ordering no.
example: 066.011 + 17 = 066.011.17

Welded nipple with radius

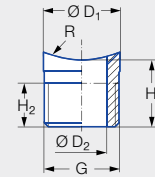

Series	Ordering no.		G BSPP	Dimensions [mm]				Weight [g]
	Type	Mat. no. 17 Stainless steel 316Ti		H ₁	H ₂	Ø D ₁	Ø D ₂	
226/216/2TR/302/308/350/ 468/652/684/548/679	065.217.17.yy¹	●	3/8 A	15.0	10.0	17.2	11.5	20.0
306/307/502/503/656/657	065.612.17.yy¹	●	3/4 A	23.0	14.0	28.0	18.0	61.0

¹ Replace "yy" with the desired radius R (R = 10/13/16/20/25 or 31 mm).

Double nipple

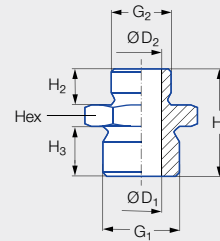

Series	Ordering no.		G ₁ BSPP	G ₂ BSPP	Dimensions [mm]						Weight [g] (Brass)	
	Type	Mat. no.			H ₁	H ₂	H ₃	Ø D ₁	Ø D ₂	Hex		
		17 Stainless steel 316Ti	30 Brass									
226/216/2TR/ 302/308/350/ 468/652/684/ 548/679	065.215¹	●	●	3/8	1/4	25.0	10.0	10.0	10.0	7.0	22	30.0
	065.215.xx.02²	●	●	3/8	1/4	35.0	10.0	10.0	11.6	7.0	22	32.0
	065.211	●	●	3/8	3/8	25.0	10.0	10.0	11.5	–	22	25.0
	065.211.xx.04²	●	●	3/8	1/2	30.0	10.0	14.0	11.5	–	27	62.0
306/307/502/503/ 656/657	065.611	●	●	3/4	3/4	35.0	14.0	14.0	18.0	–	32	90.0

¹ Not to be used with non-return valve or strainer.

² Replace "xx" with the desired material no.

Ordering Type + Material no. = Ordering no.
example: 065.217.17.yy + 17 = 065.217.17.yy.17

Ball joints with threaded connection



Ball joints with female thread

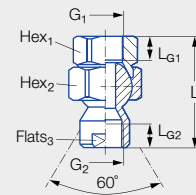

For all nozzles with	Ordering no.				G ₁ BSPP	G ₂ BSPP	Dimensions [mm]						Weight [g] (Brass)
	Type	Mat. no.		Code			L	L _{G1}	L _{G2}	Hex ₁	Hex ₂	Flats	
		16 Stainless steel 303	30 Brass										
1/8" male thread	092.010	●	●	AB	1/8	1/8	43.1	8.0	8.0	22	24	13	110.0
1/4" male thread	092.020	●	●	AD	1/4	1/4	60.3	12.0	11.5	27	27	17	200.0
	092.021	●	●	AF	3/8	1/4	58.3	12.0	11.5	27	27	17	160.0
3/8" male thread	092.030	●	●	AF	3/8	3/8	56.0	12.0	12.0	27	30	19	185.0
1/2" male thread	092.040	●	●	AH	1/2	1/2	71.0	15.5	15.5	36	41	24	425.0
3/4" male thread	092.050	●	●	AL	3/4	3/4	80.0	17.0	17.0	41	46	30	595.0

Ball joints with male thread

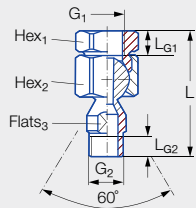

Series	Ordering no.				G ₁ BSPP	G ₂ BSPP	Dimensions [mm]						Weight [g] (Brass)
	Type	Mat. no.		Code			L	L _{G1}	L _{G2}	Hex ₁	Hex ₂	Flats	
		16 Stainless steel 303	30 Brass										
226/216/2TR/ 302/308/350/ 468/652/684/ 548/679	092.022	●	●	AD	1/4	3/8	64.0	12.0	10.0	27	27	17	135.0
	092.022	●	●	AF	3/8	3/8	62.0	12.0	10.0	27	27	17	165.0

Compact ball joints

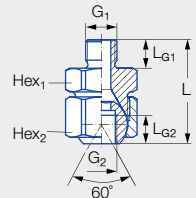

For all nozzles with	Ordering no.				G ₁ BSPP	G ₂ BSPP	Dimensions [mm]					Weight [g] (Brass)
	Type	Mat. no.		Code			L	L _{G1}	L _{G2}	Hex ₁	Hex ₂	
		16 Stainless steel 303	30 Brass									
1/8" male thread	092.010	●	●	AA	1/8	1/8	29.3	8.0	8.0	22	24	70.0
1/4" male thread	092.024	●	●	AC	1/4	1/4	44.0	12.0	12.0	27	27	140.0
3/8" male thread	092.030	●	●	AE	3/8	3/8	44.0	12.0	12.0	27	30	160.0

Ordering Type + Material no. + Code = Ordering no.
example: 092.010 + 16 + AB = 092.010.16.AB

Ball joints with welding connection



Ball joints with welding connection and female thread

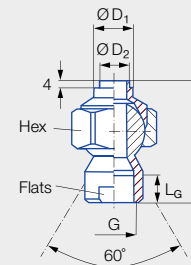

For all nozzles with	Ordering no.				G BSPP	Dimensions [mm]						Weight [g] (Brass)
	Type	Mat. no.		Code		L	L _G	Ø D ₁	Ø D ₂	Hex	Flats	
		16	30									
1/8" male thread	092.010	●	●	SB	1/8	43.0	8.0	18.0	12.0	24	13	70.0
1/4" male thread	092.020	●	●	SD	1/4	64.5	11.5	20.0	15.0	27	17	150.0
3/8" male thread	092.030	●	●	SF	3/8	59.0	12.0	22.0	15.0	30	19	165.0
1/2" male thread	092.040	●	●	SH	1/2	71.1	15.5	22.0	15.0	41	24	350.0
3/4" male thread	092.050	●	●	SL	3/4	74.8	17.0	22.0	18.0	46	30	470.0

Ball joints with welding connection and male thread

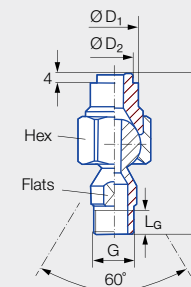

Series	Ordering no.				G BSPP	Dimensions [mm]						Weight [g]
	Type	Mat. no.		Code		L	L _G	Ø D ₁	Ø D ₂	Hex	Flats	
		16	30									
226/216/2TR/ 302/308/350/ 468/652/684/ 548/679	092.022	●		SE	3/8 A	68.0	10.0	20.0	15.0	27	17	155.0

Ordering Type + Material no. + Code = Ordering no.
example: 092.010 + 16 + SB = 092.010.16.SB

Accessories for nozzle series 676 with integrated ball joint



Threaded sockets

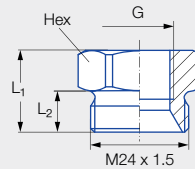

Series	Ordering no.		G BSPP	Dimensions [mm]			Weight [g] (Brass)	
	Type	Mat. no.		L ₁	L ₂	Hex		
		16						30
		Stainless steel 303	Brass					
676	092.020.xx.AF.03 ¹	●	●	3/8	20.0	10.0	27	50.0

¹ Replace "xx" by material no.

Threaded nipple

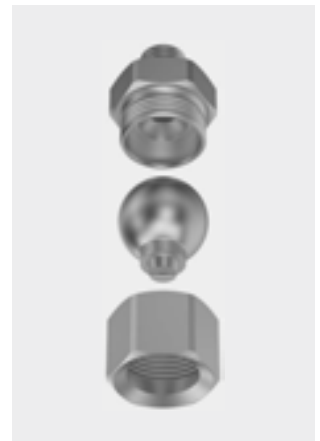
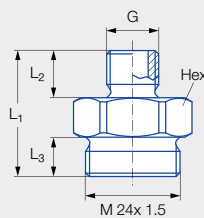

Series	Ordering no.		G BSPP	Dimensions [mm]				Weight [g] (Brass)	
	Type	Mat. no.		L ₁	L ₂	L ₃	Hex		
		16							30
		Stainless steel 303	Brass						
676	092.024.xx.AC.03 ¹	●	●	1/4	32.0	12.0	10.0	27	70.0

¹ Replace "xx" by material no.

Order Type + Material no. = Ordering no.
example: 092.020.xx.AF.03 + 16 = 092.020.16.AF.03

Welded nipple

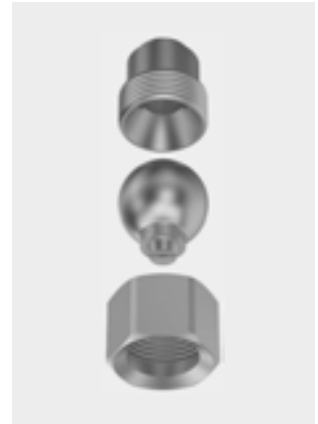
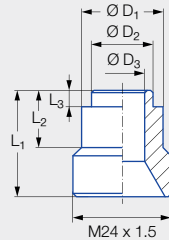

Series	Ordering no.		Dimensions [mm]						Weight [g]
	Type	Mat. no.	L ₁	L ₂	L ₃	Ø D ₁	Ø D ₂	Ø D ₃	
		17							
		Stainless steel 316Ti							
676	092.020.17.00.04	●	26.0	14.0	4.0	20.0	15.0	11.0	45.0

Retaining nuts

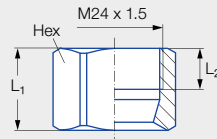

Series	Ordering no.		Dimensions [mm]				Weight [g] (Brass)
	Type	Mat. no.		L ₁	L ₂	Hex	
		16	30				
		Stainless steel 303	Brass				
676	092.020.xx.00.02 ¹	●	●	20.0	10.0	27	35.0

¹ Replace "xx" by material no.

Notice: The assembly accessories shown can be used with the low pressure flat fan nozzle with ball joint (series 676) (see Page 140/252).

Order Type + Material no. = Ordering no.
 example: 092.020.xx.00.02 + 16 = 092.020.16.00.02



Filter

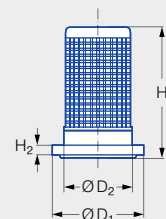

Series	Nozzle size	Ordering no.		Colour	Dimensions [mm]					Weight [g]
		Type	Mat. no.		Mesh size	H ₁	H ₂	Ø D ₁	Ø D ₂	
216/2TR/ 302/468/ 422 bayonet/ 652/646/684	xxx.32x-xxx.44x	065.257	56 POM	Blue	0.25	21.40	2.00	14.80	11.00	2.00
	xxx.48x-xxx.56x	065.256	56 POM	Red	0.65	21.40	2.00	14.80	11.00	2.00

Filter

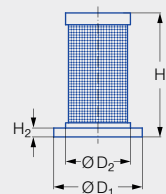

Series	Nozzle size	Ordering no.		Colour	Dimensions [mm]					Weight [g]
		Type	Mat. no.		Mesh size	H ₁	H ₂	Ø D ₁	Ø D ₂	
216/2TR/ 302/468/ 422 bayonet/ 652/646/684	xxx.32x-xxx.44x	095.016.53.15.62	53 Polypropylene	Light pink	0.08	21.00	1.60	15.00	11.00	1.00

Cup strainer

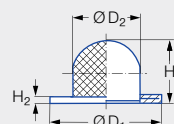

Series	Nozzle size	Ordering no.		Mesh size	Dimensions [mm]				Weight [g]
		Type	Mat. no.		H ₁	H ₂	Ø D ₁	Ø D ₂	
216/2TR/ 302/468/ 422 bayonet/ 652/646/684	xxx.32x-xxx.44x	065.252	26 Monel/Copper	0.5	8.5	1.6	14.8	9.0	1.0

Ordering Type + Material no. = Ordering no.
example: 065.257 + 56 = 065.257.56

Filters with ball-type non-return valve



Ball-type non-return valve
with integrated filter
 $P_{max} = 20 \text{ bar}$

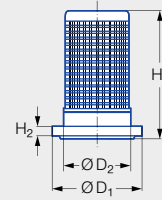

Series	Nozzle size	Ordering no.		Colour	Pressure [bar]		Dimensions [mm]					Weight [g]
		Type	Mat. no.		Opening pressure	Closing pressure	Mesh size	H ₁	H ₂	Ø D ₁	Ø D ₂	
216/2TR/ 302/468/ 422 bayonet/ 652/646/684	xxx.32x-xxx.44x	065.265	56	Blue	0.40-0.50	0.35-0.45	0.25	21.40	2.00	14.80	11.00	2.00
	xxx.48x-xxx.56x	065.266	POM	Red	0.40-0.50	0.35-0.45	0.65	21.40	2.00	14.80	11.00	2.00

Ball-type non-return valve
with integrated filter

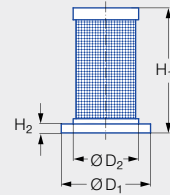

Series	Nozzle size	Ordering no.		Colour	Pressure [bar]		Dimensions [mm]					Weight [g]
		Type	Mat. no.		Opening pressure	Closing pressure	Mesh size	H ₁	H ₂	Ø D ₁	Ø D ₂	
216/2TR/ 302/468/ 422 bayonet/ 652/646/684	xxx.14x-xxx.36x	095.016.53.11.00	53	Blue	approx. 0.50	approx. 0.30	0.08	21.00	1.60	15.00	11.00	2.00
	xxx.14x-xxx.36x	095.016.53.14.63	Polypropylene	Green	approx. 2.80	approx. 1.60	0.08	21.00	1.50	15.00	11.00	2.00

Ordering Type + Material no. = Ordering no.
example: 065.265 + 56 = 065.265.56

Retaining nuts and gaskets



Retaining nuts

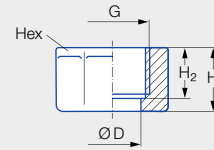

Series	Ordering no.						G BSPP	Dimensions [mm]				Weight [g] (Brass)	
	Type	Mat. no.						H ₁	H ₂	Ø D	Hex		
		16	17 ¹	1Y	30	56 Black							5E Blue
		Stainless steel 303	Stainless steel 316Ti	Stainless steel 316L	Brass	POM	PVDF						
226/2TR/ 468/652/660/ 684/548/679	065.200	●	●		●			3/8	13.0	10.0	12.8	22	25.0
	065.200					●	●	3/8	14.5	11.5	13.0	22	25.0
	069.000	●		●	●			UNF 11/16	14.3	9.7	13.1	20.6	25.0
656/657/ 664/665	065.600	●	●		●		●	3/4	16.0	13.0	20.1	32	60.0

¹ We reserve the right to supply material 316Ti or 316L under material no. 17.

Gaskets

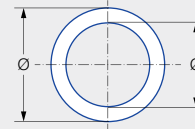

Series	Nozzle Code	Ordering no.				Dimensions [mm]	Weight [g]	
		Type	Mat. no.					
			55	71	72			73
		PTFE	Cu. ISO PL. 7504	EWP 210 (asbestos-free)	Soft rubber			
610	1/8 BSPP	061.040		●		Ø 10.00 x Ø 14.00 x 1.00	0.13	
220/612	1/4 BSPP	061.240	●	● ¹	●	Ø 13.20 x Ø 17.00 x 1.00	0.20	
490/491/ 460/461/ 616/617/689	3/4 BSPP	061.640		● ²	●	Ø 26.50 x Ø 32.00 x 1.00	0.50	
405	1 1/4 BSPP	062.140			●	Ø 42.00 x Ø 50.00 x 1.00	1.20	
405	2 BSPP	062.540			●	Ø 60.00 x Ø 70.00 x 2.00	3.92	
226/468/652/ 684/679	Retaining nut 3/8	065.240	●		●	Ø 11.00 x Ø 15.00 x 1.00	0.14	
656/657	Retaining nut 3/4	065.640			●	Ø 18.00 x Ø 24.00 x 1.00	0.50	
PTFE sealing tape For connecting cylindrical female threads and tapered male threads BSPT		095.009.55.09.30.0				12 mm x 0.1 mm x 12 m	-	

¹ Dimensions [mm] for mat. no. 71: 13.20 x 17.00 x 2.00.

² Dimensions [mm] for mat. no. 71: 26.50 x 32.00 x 2.50.

Ordering Type + Material no. = Ordering no.
example: 065.200 + 16 = 065.200.16

Strainers

Max. 12 bar



Standard strainer for industrial application

- For operating pressure levels up to 12 bar.
With large filter surfaces
- Mesh size is colour coded:
 - 0.6 mm = red
 - 0.3 mm = blue
 - 0.2 mm = green
- Easy handling
- Robust version
- Slender design

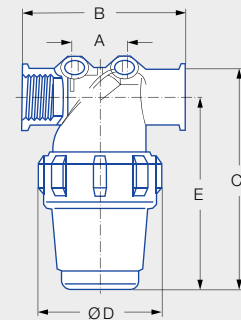

Type		Code BSPP	Dimensions [mm]					Weight [g]
			A	B	C	S	ØD	
S.GA2.	S.GI2.	1/2	27.0	97.0	140.0	118.0	74.0	200.0
S.GA3.	S.GI3.	3/4	27.0	97.0	140.0	118.0	74.0	200.0
S.GA4.	S.GI4.	1	40.0	112.0	175.0	143.0	86.0	300.0
S.GA5.	S.GI5.	1 1/4	39.0	146.0	280.0	239.0	116.0	630.0
S.GA6.	S.GI6.	1 1/2	39.0	146.0	280.0	239.0	116.0	630.0

Pressure/Temperature ranges

Max. temperature [°C]	p _{max} [bar]
20	12
60	7

	Ordering no.			Standard strainer insert/Standard filter	
	Type	Size	Mat. no.	Mesh size [mm]	Type (blue)
			53 Polypropylene		
Male thread	S.GA2.	012.	●	0.3	S.000.012.00.26.03
	S.GA3.	034.	●	0.3	S.000.012.00.26.03
	S.GA4.	100.	●	0.3	S.000.100.00.26.03
	S.GA5.	114.	●	0.3	S.000.114.00.26.03
	S.GA6.	112.	●	0.3	S.000.114.00.26.03
Female thread	S.GI2.	012.	●	0.3	S.000.012.00.26.03
	S.GI3.	034.	●	0.3	S.000.012.00.26.03
	S.GI4.	100.	●	0.3	S.000.100.00.26.03
	S.GI5.	114.	●	0.3	S.000.114.00.26.03
	S.GI6.	112.	●	0.3	S.000.114.00.26.03

Optional strainer inserts			
Mesh size [mm]	Type (red)	Mesh size [mm]	Type (green)
0.6	S.000.012.00.26.06	0.2	S.000.012.00.26.02
0.6	S.000.012.00.26.06	0.2	S.000.012.00.26.02
0.6	S.000.100.00.26.06	0.2	S.000.100.00.26.02
0.6	S.000.100.00.26.06	0.2	S.000.100.00.26.02
0.6	S.000.114.00.26.06	0.2	S.000.114.00.26.02
0.6	S.000.114.00.26.06	0.2	S.000.114.00.26.02
0.6	S.000.012.00.26.06	0.2	S.000.012.00.26.02
0.6	S.000.012.00.26.06	0.2	S.000.012.00.26.02
0.6	S.000.012.00.26.06	0.2	S.000.012.00.26.02
0.6	S.000.100.00.26.06	0.2	S.000.100.00.26.02
0.6	S.000.100.00.26.06	0.2	S.000.100.00.26.02
0.6	S.000.114.00.26.06	0.2	S.000.114.00.26.02
0.6	S.000.114.00.26.06	0.2	S.000.114.00.26.02

Notice: Standard strainer insert (blue) included in the scope of supply.

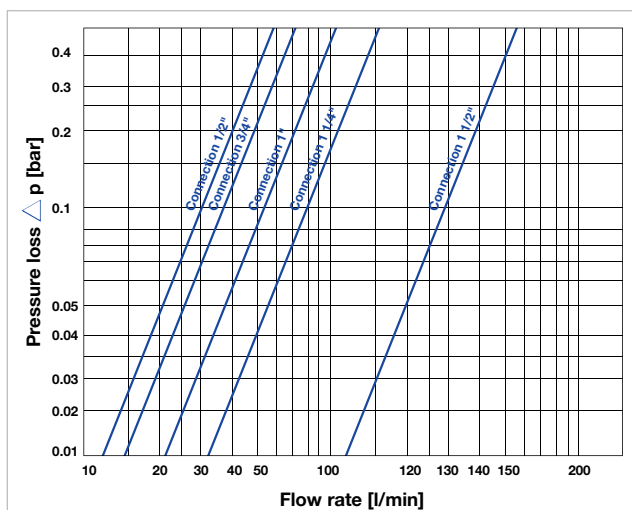

Correction factors for Δp

Viscosity [mPa·s]	Basket - mesh size [mm]		
	0.6	0.3	0.2
1.0 (water)	1.0	1.2	1.4
100.0	1.6	1.9	2.0
200.0	1.7	2.2	2.3

Ordering Type + Size + Material no. = Ordering no.
example: S.GA2. + 012. + 53 = S.GA2.012.53

Strainers

Max. 8 bar



Strainer with high flow rate and low resistance

- Integrated flow deflector prevents clogging of the filter insert
- Dirt particles can be removed via an offset outlet port
- Prepared for the install of two pressure gauges

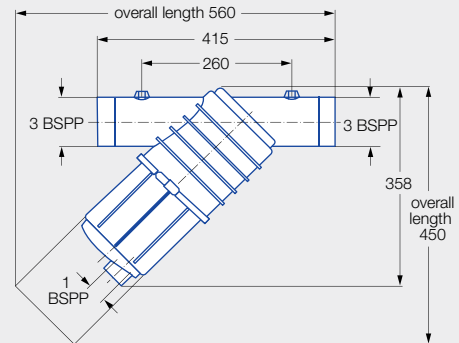

Strainer with screen

Ordering no.		Mat. no.	Screen mesh size [µm/mesh]
Type	Size		
		53	
		Polypropylene	
S.GA2.	300.	●	594/32
S.GA3.	300.	●	365/50
S.GA4.	300.	●	173/100
S.GA5.	300.	●	144/120

Screen

Ordering no.		Mat. no.		Screen mesh size [µm/mesh]
Type	Size	26	5A	
		Stainless steel 304	Polyester/ Stainless steel	
S.002.	300.00.	●		594/32
S.003.	300.00.	●		365/50
S.004.	300.00.	●		173/100
S.005.	300.00.		●	144/120

Pressure loss chart

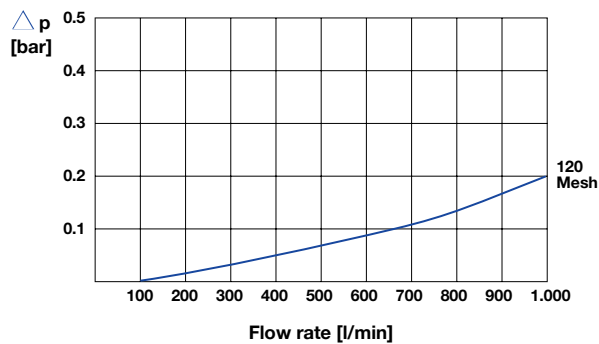

Technical data

Screening surface	860 cm ²
Screening insert Ø	145 mm
Height of screening insert	320 mm
Inflow/Outflow port Ø	3"
Pressure gauge connection Ø	1/4 BSPP
Max. operating pressure	8 bar

Ordering example for strainer:

Ordering Type + Size + Material no. = Ordering no.
 example: S.GA2. + 300. + 53 = S.GA2.300.53

Ordering example for strainer insert:

Ordering Type + Size + Material no. = Ordering no.
 example: S.002. + 300.00. + 26 = S.002.300.00.26



▶▶ PLANNING AIDS

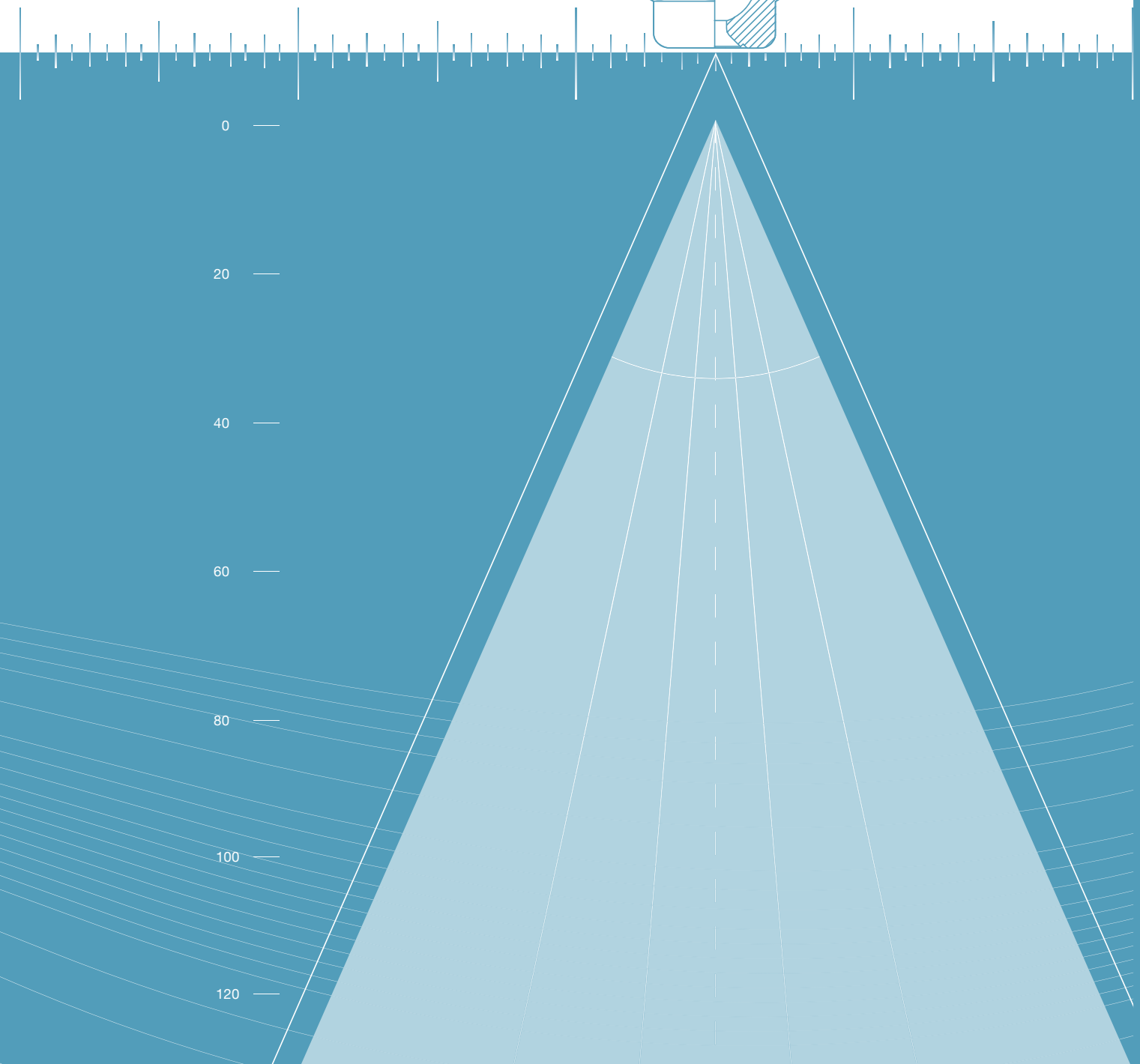
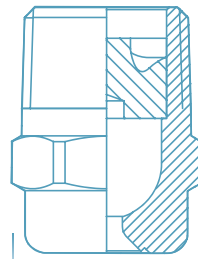

» PLANNING AIDS YOU CAN COUNT ON OUR SUPPORT



To achieve the optimum spray pattern for your application, numerous influencing factors must be taken into account. The following provides an overview of the key parameters. Needless to say, we will be more than happy to help you find the ideal nozzle.

- **Flow rate**
- **Droplet size**
- **Spray angle**
- **Viscosity**
- **Impact**
- **Nozzle arrangement**
- **Determination of the pipe diameter**
- **Conversion tables**
- **Lechler online services**
- **Certificates and declarations**





Flow rate conversion

With single element nozzles, the flow rate is controlled exclusively via the connection pressure. The following correlation applies:

	Axial-flow full cone nozzles	All other single element nozzles
Calculation of the flow rate \dot{V} [l/min] at a given pressure p [bar]	$\dot{V}_2 = \left(\frac{p_2}{p_1}\right)^{0,4} \cdot \dot{V}_1$	$\dot{V}_2 = \sqrt{\frac{p_2}{p_1}} \cdot \dot{V}_1$
Calculation of the pressure p [bar] at a given flow rate \dot{V} [l/min]	$p_2 = \left(\frac{\dot{V}_2}{\dot{V}_1}\right)^{2,5} \cdot p_1$	$p_2 = \left(\frac{\dot{V}_2}{\dot{V}_1}\right)^2 \cdot p_1$

Flow rate via pressure

Pressure-flow rate chart for two single element nozzles

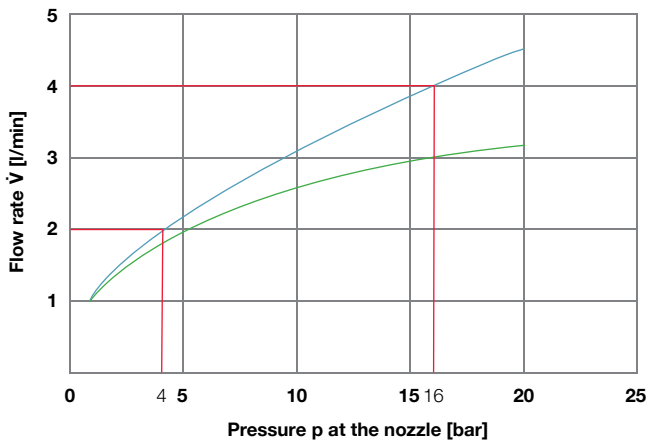

- Flow rate axial-flow full cone nozzle
- Flow rate of all other single element nozzles

All pressure values refer to the difference Delta p between the connection pressure and the ambient pressure.

$$\Delta p = p_1 - p_2$$



To double the flow rate, four times the connection pressure is, thus, required for all single element nozzles, except for axial-flow full cone nozzles.

Flow rate as a function of the medium density

For media with a lower density than water, the volume rate increases.

$\dot{V}_W = \frac{\dot{V}_{F1}}{X}$	\dot{V}_W = flow rate of water [l/min, l/h]
$\dot{V}_{F1} = \dot{V}_W \sqrt{\frac{\rho_W}{\rho_{F1}}} = \dot{V}_W \cdot X$	\dot{V}_{F1} = flow rate of the liquid whose density deviates from 1,000 [kg/m ³]
$X = \sqrt{\frac{\rho_W}{\rho_{F1}}}$	X = multiplier ρ = density [kg/m ³]
ρ_{F1}	500 600 700 800 900 1,000 1,100 1,200 1,300 1,400 1,500 1,600 1,700 1,800 1,900 2,000
X	1.41 1.29 1.20 1.12 1.06 1.00 0.95 0.91 0.88 0.85 0.82 0.79 0.77 0.75 0.73 0.71

PLANNING AIDS

DROPLET SIZE



Each nozzle produces a spray of differently sized droplets (polydisperse spray). For many applications (e.g. evaporative cooling, absorption processes), the size of the total surface area of all the droplets is crucial. The Sauter mean diameter (D_{32}) was defined for this reason.

If you transform the total volume of the droplets of a spray into droplets of equal size, which in sum would have the identical volume/surface ratio as the actual spray, these droplets would have the Sauter mean diameter.

Monodisperse spray
(quite rare in reality)

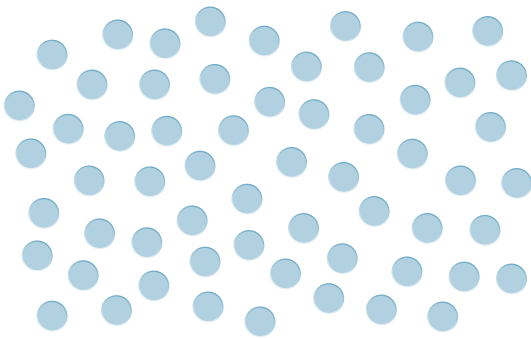

Typical droplet distribution of the spray of a single element nozzle

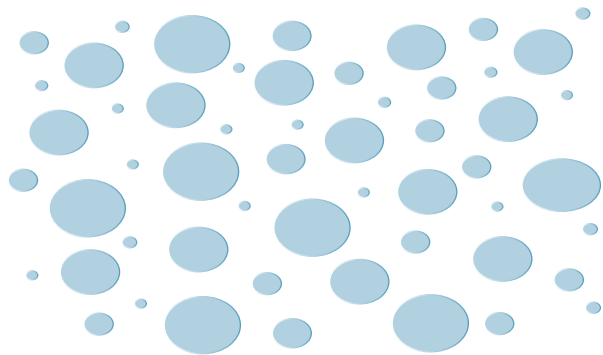

The sprays have varying droplet sizes. However, the ratio of surface area to volume is the same for both and thus also their Sauter mean diameter.

Rough classification of droplet sizes

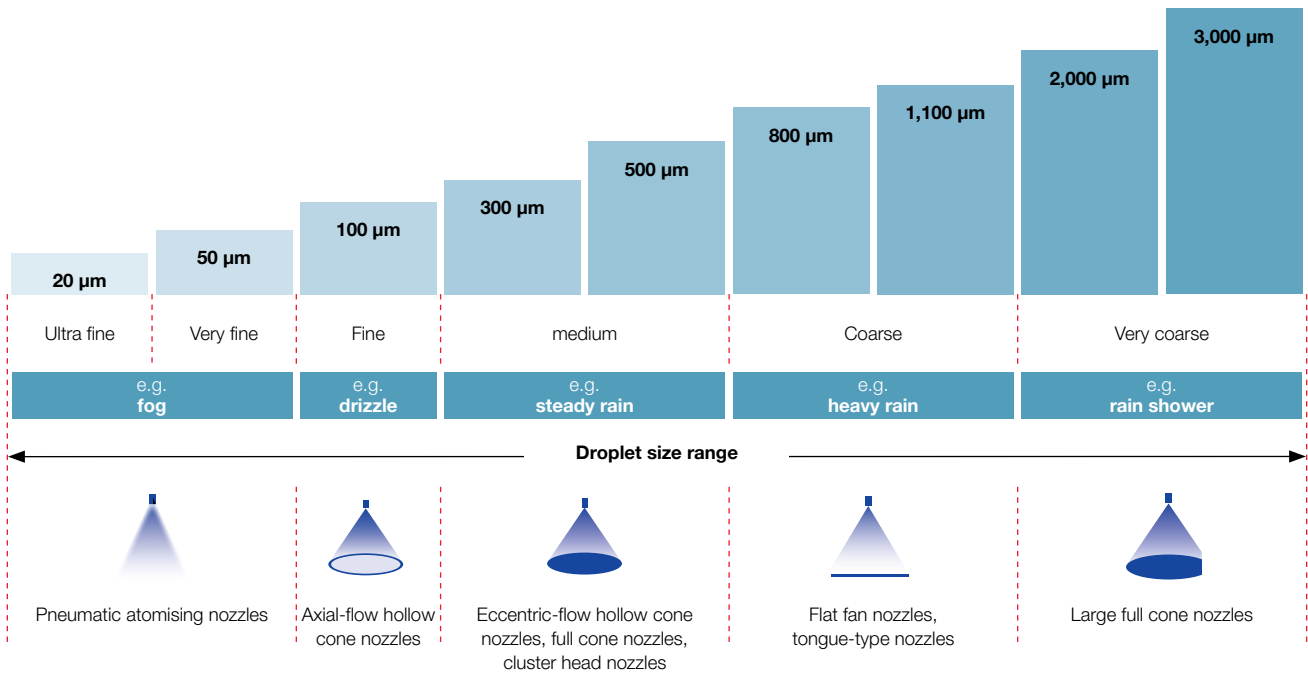

Droplet diameter as a function of the operating pressure

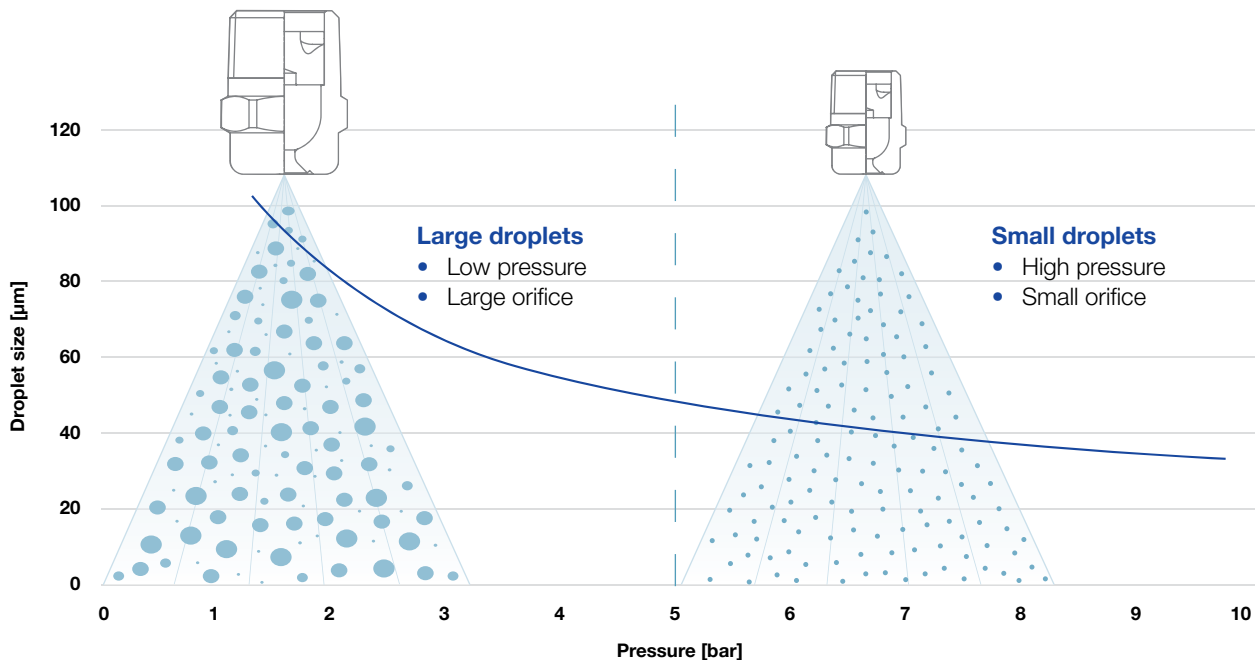

Influences on the droplet size

The following applies in general to all single element nozzles:

- The higher the **operating pressure**, the finer the droplets.
- The smaller the **nozzle outlet bore**, the finer the droplets.
- The higher the **viscosity** of the medium being atomised, the larger the droplets.



Cone and flat fan nozzles are available with varying spray angles. The spray angle can significantly influence the result of the process and should, therefore, be chosen carefully. The angles specified in the tables apply to operation with water at the respective design pressure. In case of deviating operating conditions, the angle may deviate from this value.

Influences on the spray angle

The following factors influence the size of the spray angle:

- **Pressure**

The operating pressure has a significant influence on the spray angle. At very low or very high pressure levels, the spray angle is smaller than at the optimum operating pressure.

- **Distance**

At small distances, the spray width initially increases with the distance and can be determined easily using the trigonometric function. Straight-line pattern can be assumed. With greater spraying heights, the trajectory points increasingly downwards, thus reducing the effective spray angle.

- **Viscosity**

The higher the viscosity of the liquid being sprayed, the smaller the spray angle. The viscosity of liquids can usually be reduced by heating them up.

Change in the spray pressure

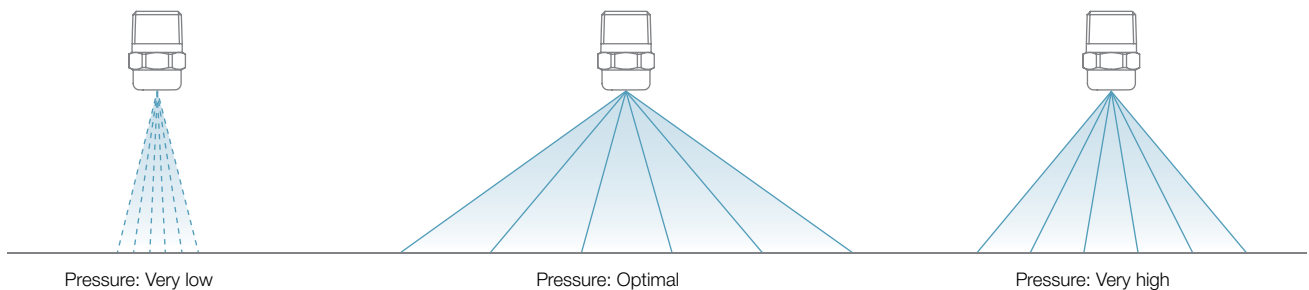

Height of the nozzle position

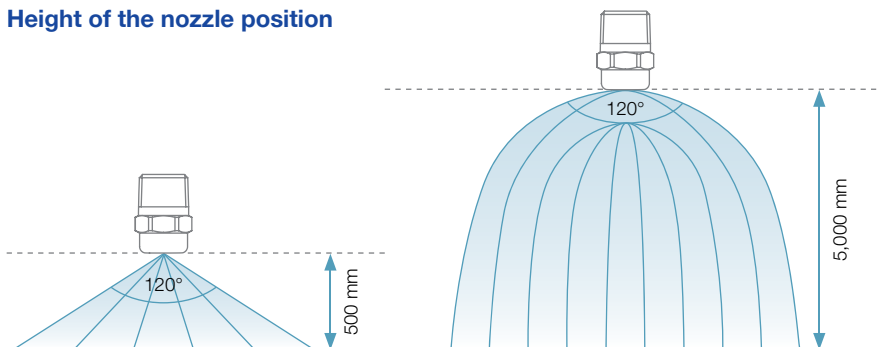



The viscosity of a liquid has a significant influence on the spray behaviour of the nozzle. When selecting the right nozzle, the viscosity must, therefore, be taken into account.

Single element nozzle

Example: Hollow cone, full cone, flat fan nozzles

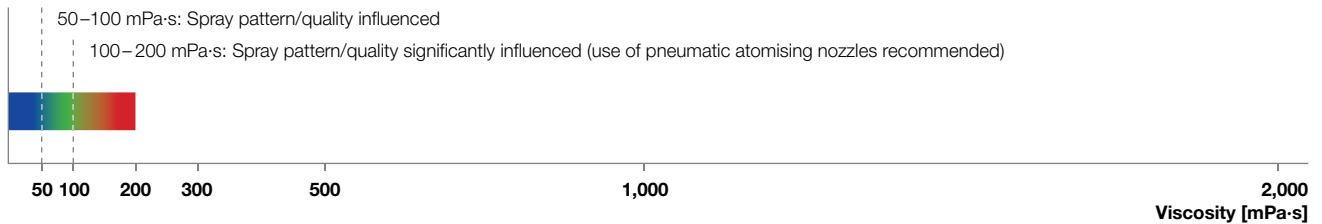

Pneumatic atomising nozzles (internal mixing)

Example: Series 136.1, 136.2, 136.4, 136.5, 166.1, 166.2, 166.4, 140

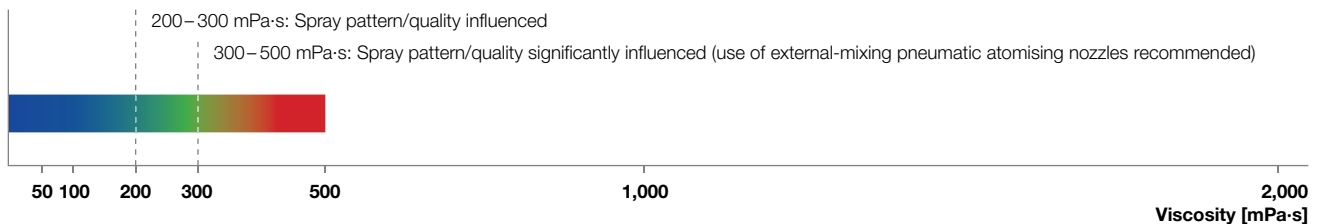

Pneumatic atomising nozzles (external mixing)

Example: Series 136.3, 136.6, 166.6, 176

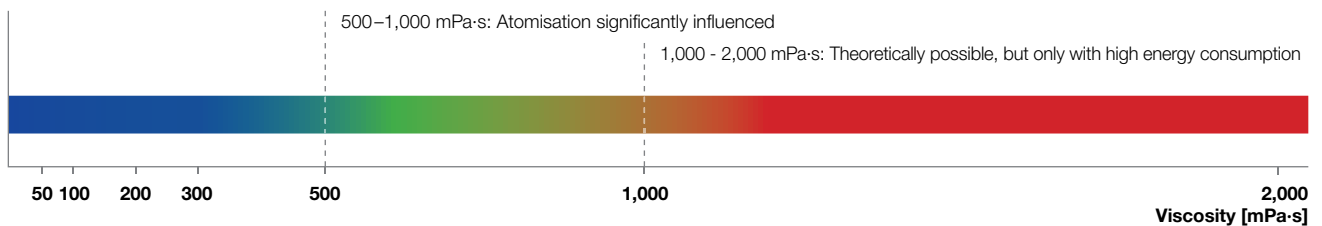

- No influence on the spray pattern
- Influence on the spray pattern
- Significant influence on the spray pattern

Medium	Temperature [°C]	Viscosity [mPa-s]
Water	20	1
Milk	20	2
Olive oil	20	108
Olive oil	60	20
Sugar solution 65° Bx	20	120
Sugar solution 70° Bx	20	400
Gelatine	45	1,200

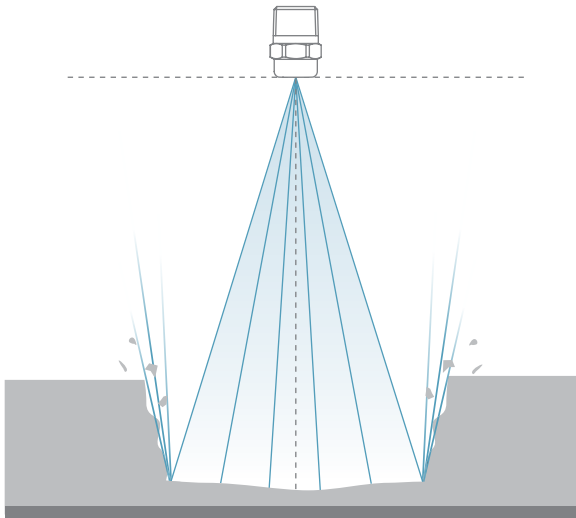

Impact is the pressure in N/mm^2 that the spray jet generates as it strikes the surface. This is crucial for the majority of cleaning tasks. The greater the impact, the better the cleaning result. Lechler high pressure nozzles are characterised by a uniformly high impact across the entire spray width.

$$I = \frac{\text{Impact force}}{\text{Impact surface}} = \frac{F}{A} \quad [\text{N/mm}^2]$$

Influences on the impact

The following factors influence the size of the impact:

- **Impact surface and jet shape**

The impact surface is the area where the spray jet strikes. The smaller the impact surface, the greater the impact. The highest impact values can be achieved with solid stream nozzles and flat fan nozzles with a small spray angle.

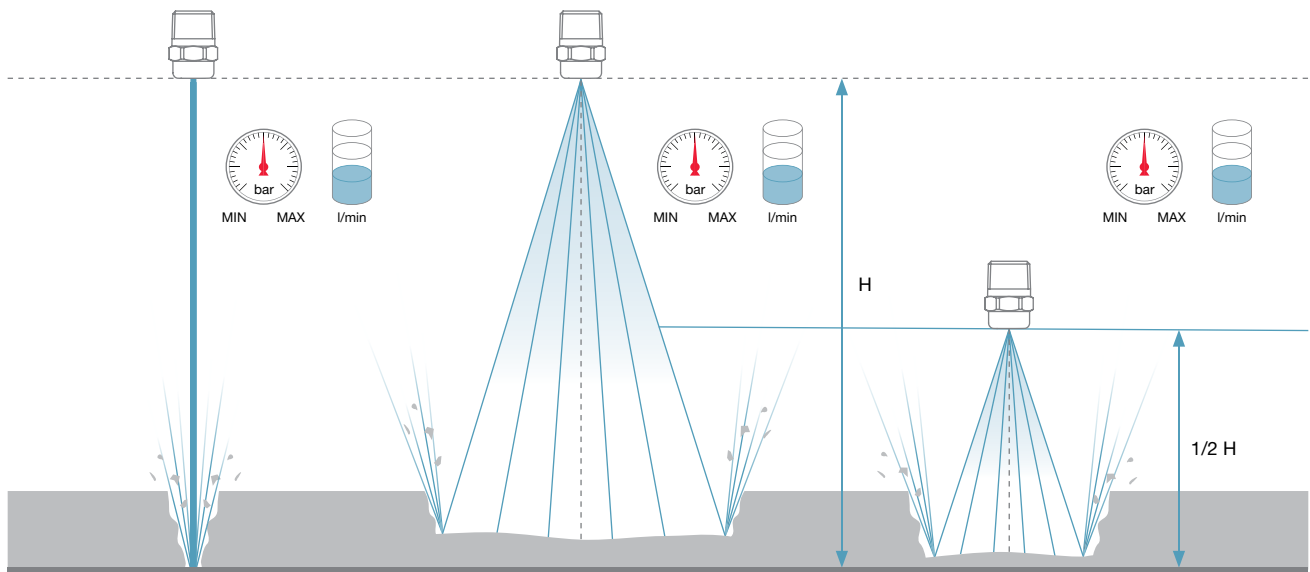

Comparison of the cleaning result of three nozzles at an identical pressure level and flow rate.

- **Pressure**

An increase in the connection pressure leads to an increase in the impact.

- **Flow rate**

An increase in the flow rate by using a larger nozzle leads to a higher impact with otherwise unchanged parameters (spray angle, pressure and medium).

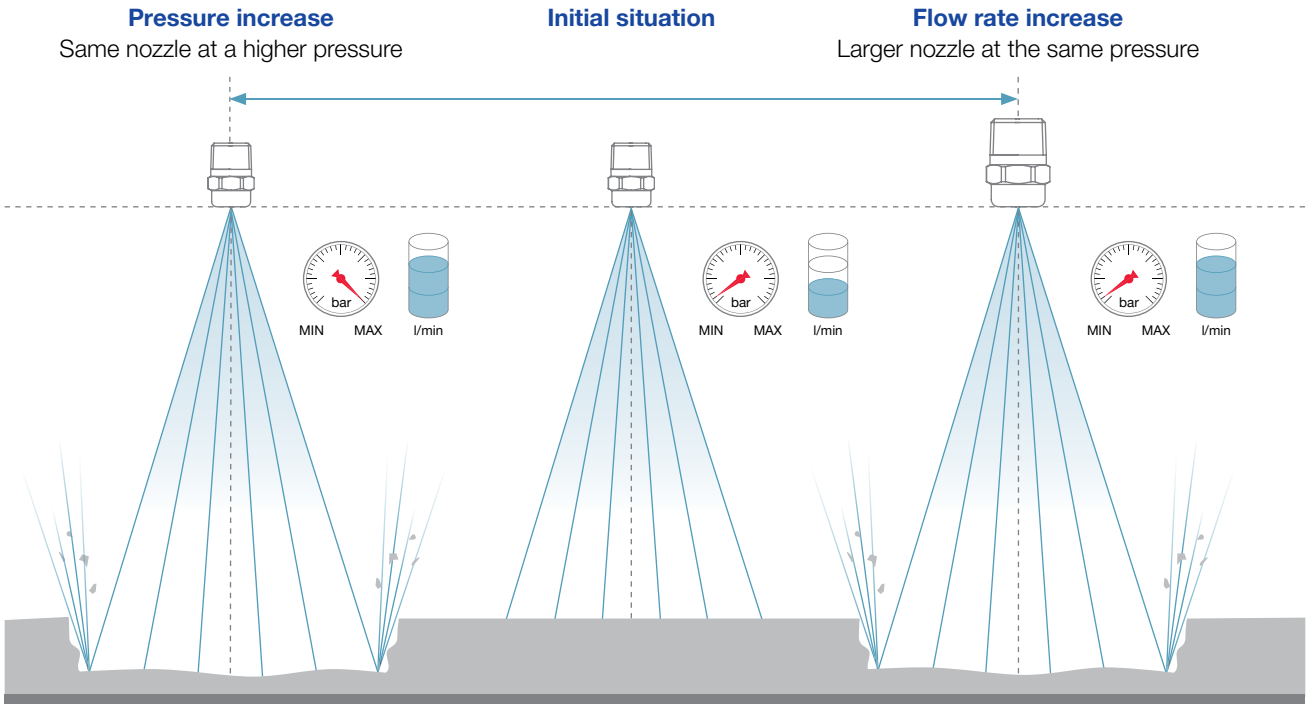

Comparison of the cleaning result of three nozzles with an increase in the pressure level and flow rate.

PLANNING AIDS

NOZZLE ARRANGEMENT



Arrangement of flat fan nozzles with parabolic liquid distribution

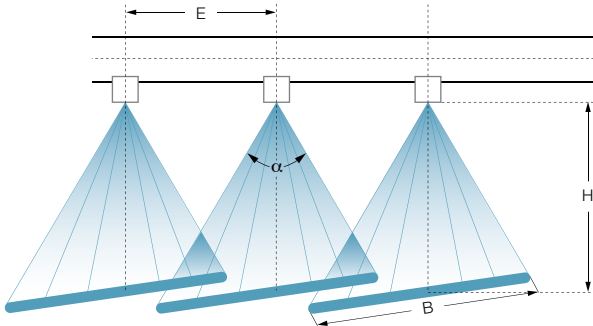

Lechler flat fan nozzles ensure consistent, uniform coverage over the impact surface. For this purpose, the spray widths B should overlap by approx. 1/3 to 1/4. To stop the sprays interfering with each other, the nozzles should be aligned at an angle of approx. 5-15° to the longitudinal axis of the pipe.

Arrangement of tongue-type nozzles

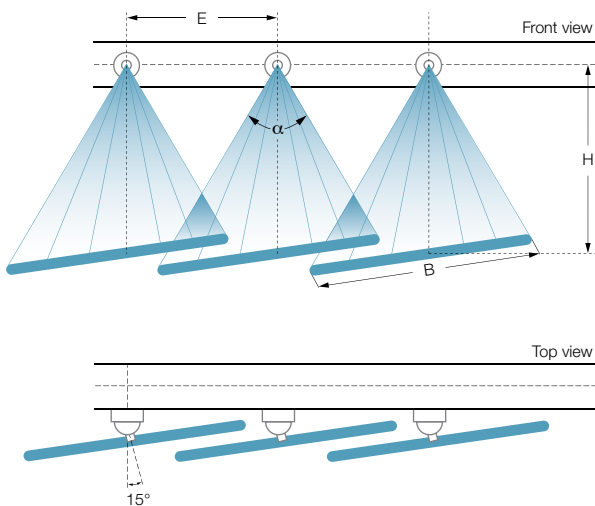

To achieve uniform impact surface coverage, the tongue-type nozzles must be arranged in such a way that the spray widths B overlap by 1/3 to 1/4. Therefore, the nozzles should be inclined at an angle of 15° to the vertical of the longitudinal axis of the pipe (either with a nipple welded on at an angle or a Lechler ball joint) to prevent interference of the spray.

Arrangement of full cone nozzles and hollow cone nozzles

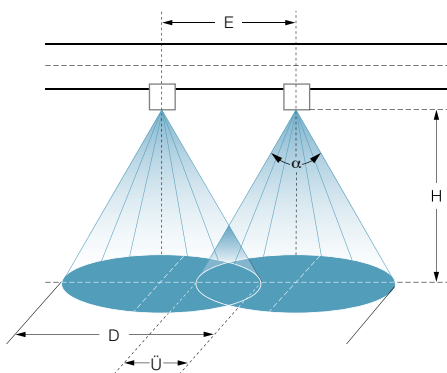

With full cone and hollow cone nozzles, the size of the nozzle distance E must ensure that the circular impact surfaces overlap by approx. 1/3 to 1/4.

E = nozzle distance H = nozzle installation height B = spray width α = spray angle \ddot{U} = overlapping of the spray angle D = spray diameter

Square and offset arrangement of full cone nozzles and hollow cone nozzles

Square arrangement

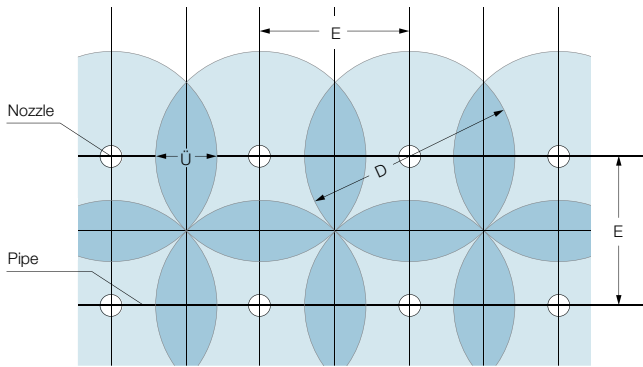

$$\text{Nozzle distance: } E = \frac{D}{\sqrt{2}}$$

$$\text{Overlapping: } \ddot{U} = D - E$$

In addition to these arrangement suggestions, please note the information on the spray angle on Page 264 and request a detailed spray width diagram, if required.

Offset arrangement

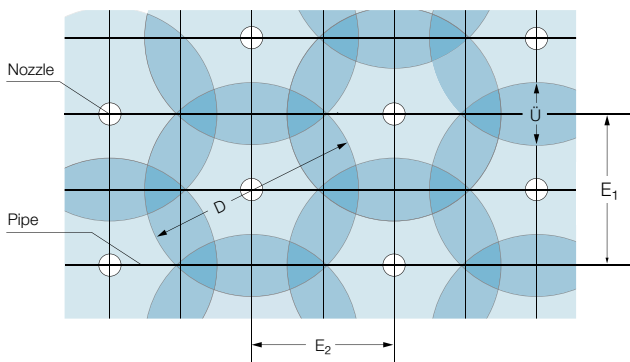

$$\text{Nozzle distance: } E_1 = \frac{D}{2} \cdot \sqrt{3}$$

$$\text{Nozzle distance: } E_2 = \frac{3}{4} \cdot D$$

$$\text{Overlapping: } \ddot{U} = D - E_1$$



PLANNING AIDS

DETERMINATION OF THE PIPE DIAMETER

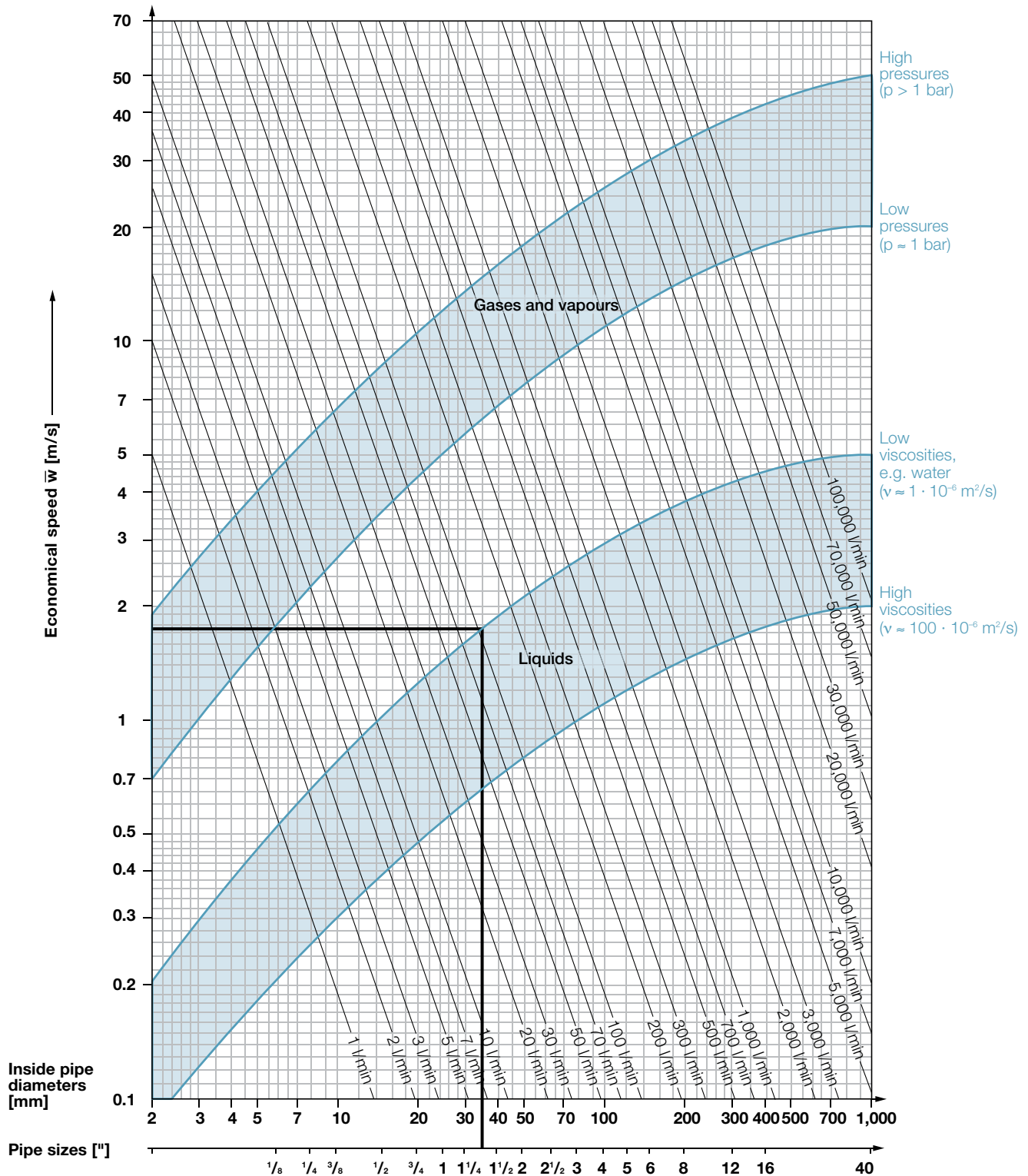

The flow rate data in the diagram refers to gases and steam in operating condition.

Example

You want to atomise 100 litres of water a minute. The viscosity of water is $\nu \approx 1 \cdot 10^{-6} \text{ m}^2/\text{s}$. In the diagram above, look for the intersection of the corresponding viscosity curve and the flow rate lines. Using the coordinates of this point, you can discover the correct inner pipe diameter or pipe size and the most efficient speed.



All the flow rate data in this catalogue is based on measurements with water and takes into account the individual flow parameters of the various nozzle designs.

p pressure

Unit	Conversion			
	bar	Pa = N/m ²	psi	lb/sq ft.
1 bar	1	100,000	14.5	2,089
1 Pa	$1 \cdot 10^{-5}$	1	$14.5 \cdot 10^{-5}$	0.0209
1 psi	0.06895	6,895	1	144
1 lb/sq ft.	$0.479 \cdot 10^{-3}$	47.9	$6.94 \cdot 10^{-3}$	1

V volume

Unit	Conversion			
	l	m ³	Imp. gal	US gal
1 l (1 dm ³)	1	$1 \cdot 10^{-3}$	0.22	0.264
1 m ³	1,000	1	220	264.2
1 Imp. gal	4,546	$4,546 \cdot 10^{-3}$	1	1,201
1 US gal	3,785	$3,785 \cdot 10^{-3}$	0.8327	1

V flow rate

Unit	Conversion				
	l/s	l/min	m ³ /h	Imp. gal	US gal
1 l/s	1	60	3.6	15.85	13.2
1 l/min	0.0167	1	0.06	0.2642	0.22
1 m ³ /h	0.2778	16.67	1	4.4	3.66
1 Imp. gal/min	0.0631	3.785	0.227	1	0.8327
1 US gal/min	0.076	4.546	0.273	1.201	1

Determination of the external thread diameter

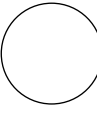
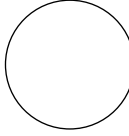
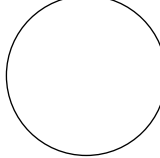
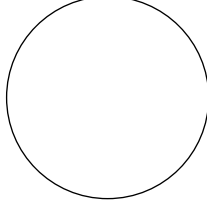
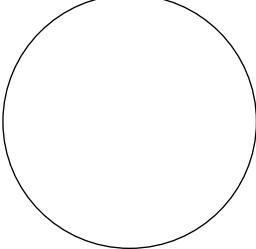
						
Nominal size of thread ["] for ISO 228 and EN 10226	1/8	1/4	3/8	1/2	3/4	1

ISO 228 threads are cylindrical and usually require a separate flat gasket or R-ring for sealing.
EN 10226 threads are conical and can be sealed with sealing tape, etc.



You can find all the latest information about Lechler, our products and services at any time at www.lechler.com.

3D design data

With the free 3D design data of Lechler nozzles and accessories, we support your design needs at every step.



After registering free of charge, you can download the required data packs in all common CAD formats at <http://lechler.partcommunity.com>.

- Time-saving, direct download of construction drawings and technical data
- Simple product selection similar to the Lechler print catalogue
- Preview function with product photo and 3D graphics
- Available in all common 3D file formats

Always at hand – the Lechler industry app

The Lechler industry app provides all important calculation and conversion programs combined in one interface:

- Unit calculator for pressure, volume and flow rate
- Pressure/Flow rate calculator for single element nozzles, including axial-flow full cone nozzles
- Determination of the pipe diameter



iOS (Apple)



Android (Google)

Available free of charge in the Apple App Store and the Google Play Store.



PLANNING AIDS CERTIFICATES AND DECLARATIONS



We can issue various certificates and attestations for our products. Whether the desired document can be issued for a specific product must be checked in advance. We will be more than happy to inform you of the conditions for the documents upon request.

Declaration of Compliance EN 10204 - 2.1

This declaration of compliance confirms that the products supplied have been manufactured and tested in accordance with the relevant specifications.

Test Report EN 10204 - 2.2

The test report can be issued either with regard to the material (including the non-specific material certificate of the supplier) or with regard to the spray parameters (spray angle and flow rate, without an additional document).

Inspection Certificate EN 10204 - 3.1

The inspection certificate is usually issued with regard to the material. In this case, the parts are manufactured order-related with re-stamping.

However, a specific certificate can also be issued with regard to the flow rate, spray angle, dimensions of nozzles, etc.

FDA Declaration of Conformity

Confirmation that the material used complies with FDA regulations.

Declaration of Conformity to regulation (EC) no. 1935/2004 and (EC) no. 10/2011

Confirmation that the product supplied is suitable for use with foodstuffs and that the material complies with the stated regulations.

Supplier's Declaration

Certificate issued by Lechler confirming that the products have been wholly produced or originate in the European Union. A supplier's declaration can be issued in relation to a specific order (individual supplier's declaration) or as a long-term supplier's declaration that remains valid for two years.

Certificate of Origin

Official confirmation of the origin of a product, certified by the Chamber of Commerce and Industry.



GREAT ATTENTION
TO DETAIL
PRECISION BY
LECHLER



**ENGINEERING
YOUR SPRAY SOLUTION**



Lechler GmbH · Precision Nozzles · Nozzle Systems
Ulmer Strasse 128 · 72555 Metzingen, Germany · Phone +49 7123 962-0 · info@lechler.de · www.lechler.com