

IDROBASE[®]

PASSION FOR WATER



Revolutionary line at 70bar:
stainless steel + polyamide combination

70BAR INNOVATIVE LINE STAINLESS STEEL + POLYAMIDE COMBINATION

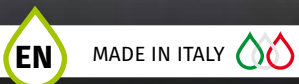

The revolution that combines stainless steel and polyamide pipes with 70bar pressure

One system, one line.

An **exclusive** by Idrobase Group: with the slip lock fittings you can connect both stainless steel and polyamide pipes.

A **revolution** for inline misting plants:

- **easy assembly** of the lines;
- **80% of time saved** for lines assembly, if compared to the ogive system;
- **one single slip lock** fitting both for stainless steel pipes and for polyamide pipes;
- now it is possible to compose **lines** using **pipes of different diameters**.



80% of time saved for lines assembly: directly and **without using tools**



Long time and skilled technicians: to assemble the line it takes a long time, and you have to use keys and other tools.



Revolutionary line at 70bar: stainless steel + polyamide combination

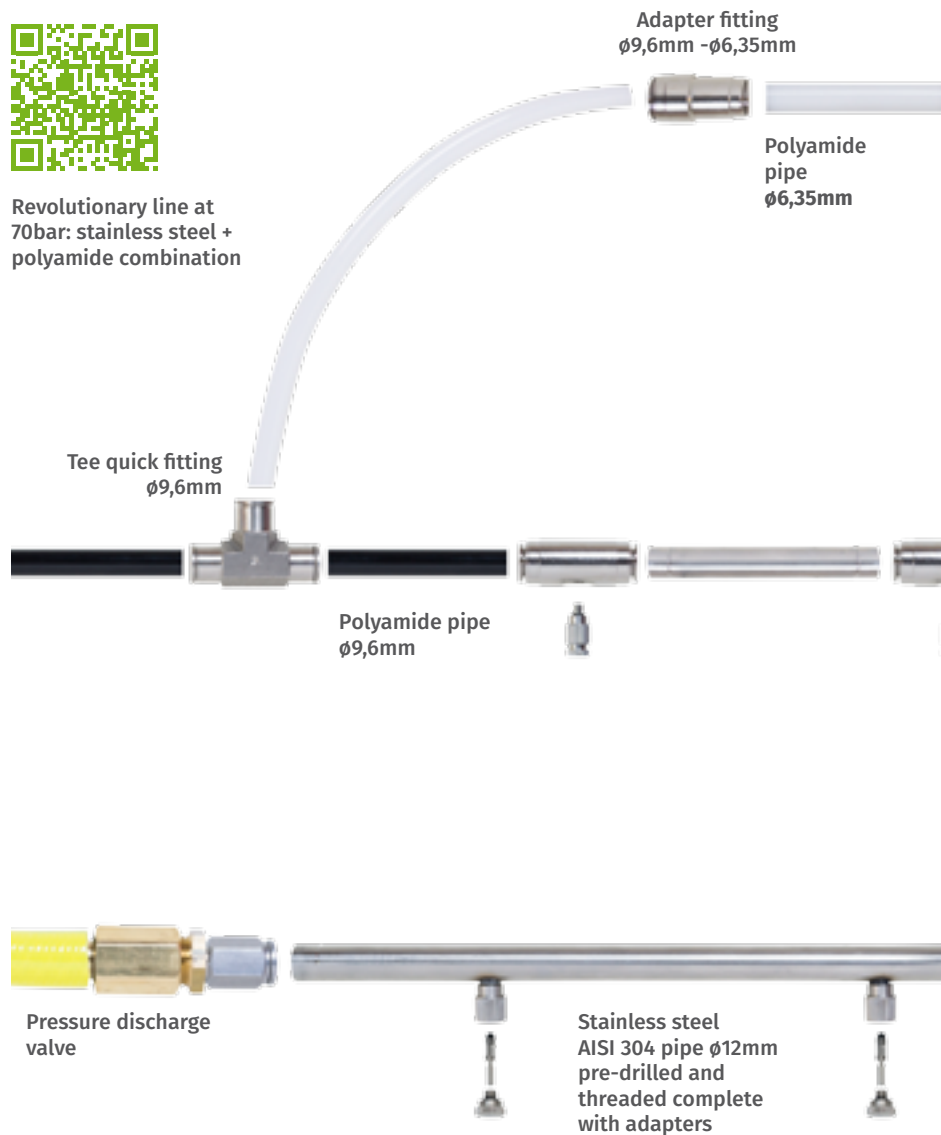

Combine stainless steel pipes and polyamide pipes: you can use polyamide sections and **there are no limits** to the lines paths that can be made.

The solution that combines steel and polyamide line: to install misting lines in a **fast, easy** and **flexible** way.



ø6,35mm

ø9,6mm

ø12mm

Stainless steel line

Polyamide connection curve



Stainless steel AISI 304 pipe ø6,35mm

Stainless steel AISI 303 anti-drip nozzle

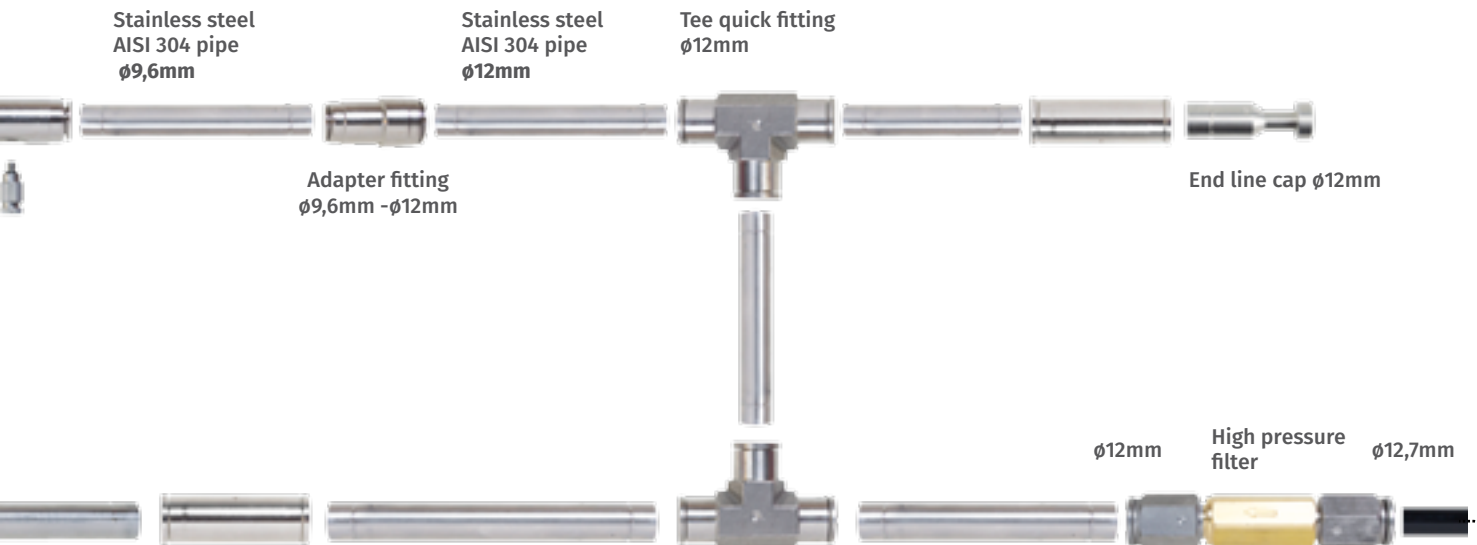

Stainless steel AISI 304 pipe ø9,6mm

Stainless steel AISI 304 pipe ø12mm

Tee quick fitting ø12mm

Adapter fitting ø9,6mm - ø12mm

End line cap ø12mm

ø12mm High pressure filter ø12,7mm



Fog Module

Polyamide pipe ø12,7mm

AISI 304 stainless steel pipe, 70bar



ø6,35mm line

	Code	Description
a	IT.SS6354L030	ø6,35mm pipe, 30cm length, made of AISI 304 stainless steel
a	IT.SS6354L075	ø6,35mm pipe, 75cm length, made of AISI 304 stainless steel
a	IT.SS6354L100	ø6,35mm pipe, 100cm length, made of AISI 304 stainless steel

ø9,6mm line

	Code	Description
a	IT.SS964-050	ø9,6mm pipe, 50cm length, made of AISI 304 stainless steel
a	IT.SS964-075	ø9,6mm pipe, 75cm length, made of AISI 304 stainless steel
a	IT.SS964-100	ø9,6mm pipe, 100cm length, made of AISI 304 stainless steel
a	IT.SS964-120	ø9,6mm pipe, 120cm length, made of AISI 304 stainless steel
a	IT.SS964-150	ø9,6mm pipe, 150cm length, made of AISI 304 stainless steel
a	IT.SS964-200	ø9,6mm pipe, 200cm length, made of AISI 304 stainless steel
a	IT.SS964-250	ø9,6mm pipe, 250cm length, made of AISI 304 stainless steel
a	IT.SS964-300	ø9,6mm pipe, 300cm length, made of AISI 304 stainless steel
a	IT.SS964-400	ø9,6mm pipe, 400cm length, made of AISI 304 stainless steel
a	IT.SS964-500	ø9,6mm pipe, 500cm length, made of AISI 304 stainless steel

MADE IN ITALY



Revolutionary line at 70bar: stainless steel + polyamide combination

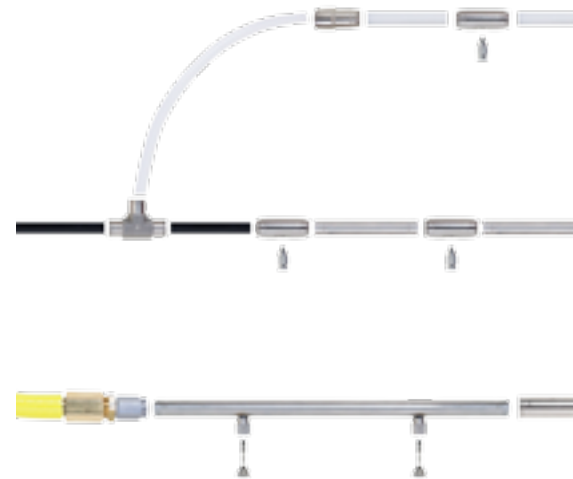

ø12mm line

	Code	Description
a	ZX.1090-3	ø12mm pipe, 3m length
a	ZX.1090-6	ø12mm pipe, 6m length

MADE IN ITALY

	Code	Description
b	IT.SS124303	ø12mm pipe, 3m length, 3 holes, 1000mm pitch, made of AISI 304 stainless steel
b	IT.SS124304	ø12mm pipe, 3m length, 4 holes, 750mm pitch, made of AISI 304 stainless steel
b	IT.SS124306	Tubo ø12mm, 3m length, 6 holes, 500mm pitch, made of AISI 304 stainless steel
b	IT.SS124603	Tubo ø12mm, 6m length, 3 holes, 2000mm pitch, made of AISI 304 stainless steel
b	IT.SS124604	Tubo ø12mm, 6m length, 4 holes, 1500mm pitch, made of AISI 304 stainless steel
b	IT.SS124606	Tubo ø12mm, 6m length, 6 holes, 1000mm pitch, made of AISI 304 stainless steel
b	IT.SS124608	Tubo ø12mm, 6m length, 8 holes, 750mm pitch, made of AISI 304 stainless steel
b	IT.SS124612	Tubo ø12mm, 6m length, 12 holes, 500mm pitch, made of AISI 304 stainless steel

MADE IN ITALY

H.p. polyamide pipes

	Code	Description
a	IT.0250	ø6,35mm h.p. polyamide pipe, rolls of 25m black*
a	IT.0279	ø9,6mm h.p. polyamide pipe, rolls of 25m black**
a	IT.0278	ø9,6mm h.p. polyamide pipe, rolls of 100m black**
a	IT.0023	ø12,7mm h.p. polyamide pipe, rolls of 50m black*
b	IT.0445	ø6,35mm h.p. polyamide pipe, rolls of 25m white*
b	IT.0079	ø9,6mm h.p. polyamide pipe, rolls of 25m white**
b	IT.0078	ø9,6mm h.p. polyamide pipe, rolls of 100m white**

MADE IN ITALY



Code	Description
IT.0574	Tube cutter for polyamide pipe from ø6,35mm to ø12,7mm



*Maximum pressure 80bar with 23°C temperature
**Maximum pressure 100bar with 23°C temperature

Slip lock fittings for $\phi 6,35\text{mm}$ pipes

MADE IN ITALY

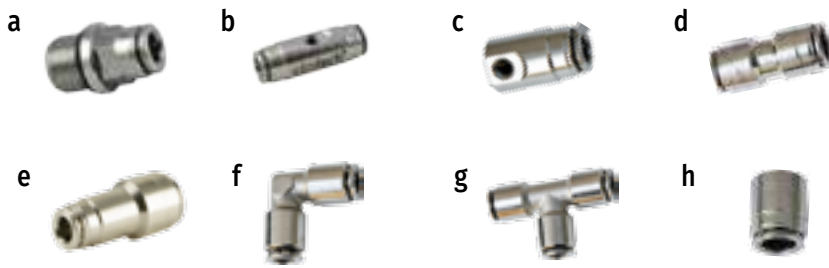

Code	Description
a	IT.0330 Start quick fitting, made of nickeled brass, G1/4" M - $\phi 6,35\text{mm}$
b	IT.0331 Straight nozzle holder quick fitting, made of nickeled brass,, $\phi 6,35\text{mm}$
c	IT.0332 End line nozzle holder quick fitting, made of nickeled brass, $\phi 6,35\text{mm}$
d	IT.0333 Straight pipe connection quick fitting, made of nickeled brass, $\phi 6,35\text{mm}$
e	IT.0334 Straight pipe connection quick fitting, made of nickeled brass, to connect $\phi 9,6\text{mm}$ to $\phi 6,35\text{mm}$ pipes
f	IT.0335 Elbow pipe connection quick fitting, made of nickeled brass, $\phi 6,35\text{mm}$
g	IT.0336 Tee pipe connection quick fitting, made of nickeled brass, $\phi 6,35\text{mm}$
h	IT.0338 End line cap in nickel-plated brass $\phi 6,35\text{mm}$

Slip lock fittings for $\phi 9,6\text{mm}$ pipes

MADE IN ITALY



Code	Description
a	IT.0339 Start quick fitting, made of nickeled brass, 1/4" G - $\phi 9,6\text{mm}$
b	IT.0340 Straight nozzle holder quick fitting, made of nickeled brass, $\phi 9,6\text{mm}$
c	IT.0341 Straight nozzle holder quick fitting, made of nickeled brass, $\phi 9,6\text{mm}$
d	IT.0342 End line nozzle holder quick fitting, made of nickeled brass, $\phi 9,6\text{mm}$
e	IT.0343 Straight pipe connection quick fitting, made of nickeled brass, $\phi 9,6\text{mm}$
f	IT.0344 Elbow pipe connection quick fitting, made of nickeled brass, $\phi 9,6\text{mm}$
g	IT.0345 Tee pipe connection quick fitting, made of nickeled brass, $\phi 9,6\text{mm}$
h	IT.0347 End of line cap in nickel-plated brass, $\phi 9,6\text{mm}$
i	IT.0334 Straight pipe connection quick fitting, made of nickeled brass, to connect $\phi 9,6\text{mm}$ to $\phi 6,35\text{mm}$ pipes

Slip lock fittings for $\phi 12,7\text{mm}$ pipes

MADE IN ITALY

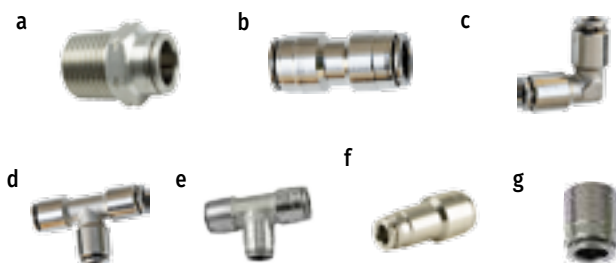

Code	Description
a	IT.0348 Start quick fitting, made of nickeled brass, $\phi 12,7\text{mm}$
b	IT.0349 Straight pipe connection quick fitting, made of nickeled brass, $\phi 12,7\text{mm}$
c	IT.0350 Elbow pipe connection quick fitting, made of nickeled brass, $\phi 12,7\text{mm}$
d	IT.0351 Tee pipe connection quick fitting, made of nickeled brass, $\phi 12,7\text{mm}$
e	IT.0352 Tee pipe connection quick fitting, made of nickeled brass, to connect $\phi 12,7\text{mm}$ to $\phi 9,6\text{mm}$ pipes
f	IT.0353 Straight pipe connection quick fitting, made of nickeled brass, to connect $\phi 12,7\text{mm}$ to $\phi 9,6\text{mm}$ pipes
g	IT.0354 End of line cap, in nickel-plated brass, for quick coupling $\phi 12,7\text{mm}$

Slip lock fittings for $\phi 12\text{mm}$ pipes

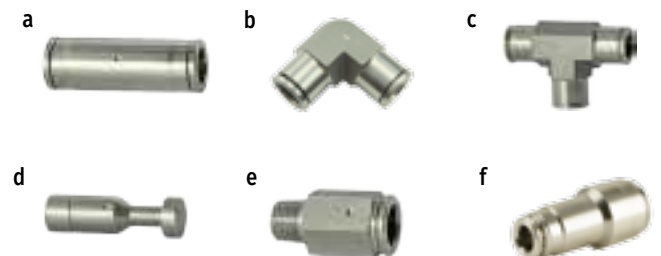

Code	Description
a	IT.0882-NB Straight fitting for $\phi 12\text{mm}$ pipe, made of nickeled brass
b	IT.0883-NB Elbow fitting for $\phi 12\text{mm}$ pipe, made of nickeled brass
c	IT.0884-NB "Tee" fitting for $\phi 12\text{mm}$ pipe, made of nickeled brass
d	IT.0886-NB End line plug for pipe $\phi 12\text{mm}$, made of nickeled brass
e	IT.0887-NB Starter fitting $\phi 12\text{mm}$ pipe, 1/4" M NPT, made of nickeled brass
f	IT.0885-NB Straight pipe connection quick fitting, made of nickeled brass, to connect $\phi 12\text{mm}$ to $\phi 9,6\text{mm}$ pipes
f	IT.0888-NB Straight pipe connection quick fitting, made of nickeled brass, to connect $\phi 12,7\text{mm}$ to $\phi 12\text{mm}$ pipes

Cleanable and anti-drip nozzle, made in AISI 303 stainless steel, for $\phi 6,35\text{mm}$ and $\phi 9,6\text{mm}$ Slip Lock



Code	Flow rate factor	Description
IT.154C	15	AISI 303 stainless steel nozzle, anti-drip, thread UNC 10/24, 0,15mm orifice, compete with body that works as adapter
IT.204C	20	AISI 303 stainless steel nozzle, anti-drip, thread UNC 10/24, 0,20mm orifice, compete with body that works as adapter
IT.304C	30	AISI 303 stainless steel nozzle, anti-drip, thread UNC 10/24, 0,30mm orifice, compete with body that works as adapter
IT.404C	40	AISI 303 stainless steel nozzle, anti-drip, thread UNC 10/24, 0,40mm orifice, compete with body that works as adapter
IT.504C	50	AISI 303 stainless steel nozzle, anti-drip, thread UNC 10/24, 0,50mm orifice, compete with body that works as adapter
IT.604C	60	AISI 303 stainless steel nozzle, anti-drip, thread UNC 10/24, 0,60mm orifice, compete with body that works as adapter
IT.704C	70	AISI 303 stainless steel nozzle, anti-drip, thread UNC 10/24, 0,70mm orifice, compete with body that works as adapter

Cleanable and anti-drip nozzle made in AISI 303 stainless steel for $\phi 12\text{mm}$ pre-drilled pipe line

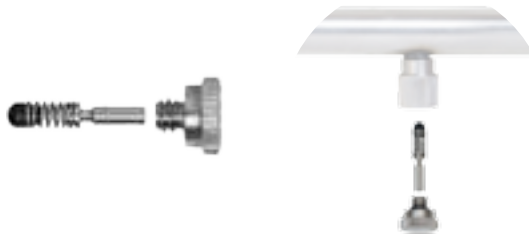

Code	Flow rate factor	Description
IT.151C	15	AISI 303 stainless steel nozzle, anti-drip, thread UNC 10/24, 0,15mm orifice
IT.201C	20	AISI 303 stainless steel nozzle, anti-drip, thread UNC 10/24, 0,20mm orifice
IT.301C	30	AISI 303 stainless steel nozzle, anti-drip, thread UNC 10/24, 0,30mm orifice
IT.401C	40	AISI 303 stainless steel nozzle, anti-drip, thread UNC 10/24, 0,40mm orifice
IT.501C	50	AISI 303 stainless steel nozzle, anti-drip, thread UNC 10/24, 0,50mm orifice
IT.601C	60	AISI 303 stainless steel nozzle, anti-drip, thread UNC 10/24, 0,60mm orifice
IT.701C	70	AISI 303 stainless steel nozzle, anti-drip, thread UNC 10/24, 0,70mm orifice

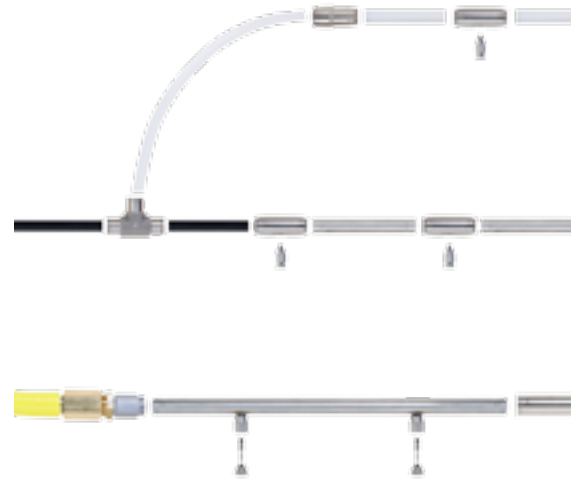

Fixing pipe systems

MADE IN ITALY

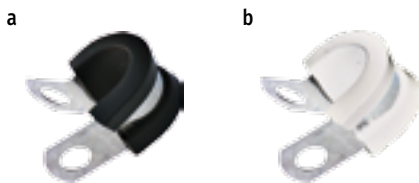

Code	Description
a CLA.PAS006	Black rubberized stainless steel clamp, to fix polyamide pipe $\phi 6,35\text{mm}$
b IT.0730	White rubberized stainless steel clamp, to fix polyamide pipe $\phi 6,35\text{mm}$
b IT.0080	White rubberized stainless steel clamp, to fix polyamide pipe $\phi 9,6 \times 5\text{mm}$
a CLA.PAS008	Black rubberized stainless steel clamp, to fix polyamide pipe $\phi 9,6 \times 5\text{mm}$
a CLA.PAS012	Black rubberized stainless steel clamp, to fix polyamide pipe $\phi 12,7\text{mm}$

MADE IN ITALY



Code	Description
ZX.1891	Anti-vibration bracket for $\phi 12\text{mm}$ pipe

Flow rate table for AISI 303 stainless steel nozzles

Nozzle flow rate factor	30bar	40bar	50bar	60bar	70bar	80bar	90bar	100bar	110bar	120bar	130bar	Pressure
15	0,024	0,038	0,043	0,047	0,050	0,058	0,064	0,068	0,070	0,072	0,075	LPM
20	0,041	0,057	0,063	0,071	0,075	0,081	0,085	0,091	0,093	0,097	0,102	LPM
30	0,070	0,082	0,091	0,102	0,105	0,116	0,122	0,132	0,140	0,146	0,150	LPM
40	0,094	0,116	0,128	0,142	0,150	0,159	0,169	0,185	0,190	0,197	0,209	LPM
50	0,117	0,136	0,160	0,180	0,190	0,195	0,209	0,228	0,235	0,240	0,250	LPM
60	0,135	0,162	0,180	0,196	0,210	0,228	0,241	0,255	0,275	0,285	0,300	LPM
70	0,161	0,184	0,209	0,228	0,240	0,256	0,274	0,294	0,305	0,315	0,330	LPM

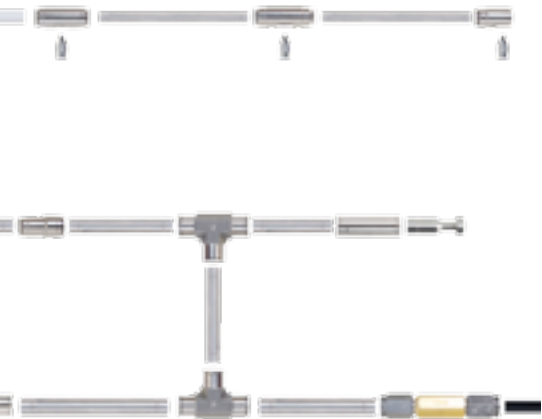

MADE IN ITALY



Code	Description
ZX.0660-14	Valve kit for ø6,35mm Slip Lock line shutoff
ZX.0524-38	Valve kit for ø9,6mm Slip Lock line shutoff
ZX.0523-12	Valve kit for ø12mm Slip Lock line shutoff
ZX.0523-12127	Valve kit for ø12-ø12,7mm Slip Lock line shutoff



Code	Description
ZX.FAP-14	Slip Lock high pressure filter, made of brass, for ø6,35mm lines
ZX.FAP-38	Slip Lock high pressure filter, made of brass, for ø9,6mm lines
ZX.FAP-12	Slip Lock high pressure filter, made of brass, for ø12mm lines
ZX.FAP-12127	Slip Lock high pressure filter, made of brass, for ø12mm-ø12,7mm lines



Code	Description
ZX.0124-38	End of line kit with automatic discharge valve for ø9,6mm pipe line
ZX.0124-12	End of line kit with automatic discharge valve for ø12mm pipe line

IDROBASE®

PASSION FOR WATER



NE - Ed. January 2018



idrobasete®

Innovative pressure washers

idrobasete.it



club dei riparatori®

The winning solution to manufacture and repair all kinds of pressure washers

clubdeiriparatori.it



Enjoy your life
Night & Day

enjoyyourfurniture.com



idrotech®

Tailor-made misting systems

idrotech.com



club del misting®

The winning solution to repair all kinds of misting system

clubdelmisting.com

Idrobasete Group s.r.l.

35010 BORGORICCO (PD) ITALIA - Via dell'Industria, 25

+39 049 9335903 +39 049 9335922

info@idrobasetegroup.com

www.idrobasetegroup.com

