

GENERAL CHARACTERISTICS



Design for side mounting

The principle of operation of these instruments is based on the drive of one or more magnetic reed contacts, placed inside of the measuring rod, by one or more floats. The only moving element is the float that moves, for buoyancy, along the measuring rod, this guarantees extreme robustness and a limited need for maintenance.

- **Brass – Spansil**
- Up to 4 switch points
- Maximum working pressure 20 bar
- Operating ambient temperature -30/+55°C UR 90%.
- Standard working temperature up to 105°C.
- Executions up to 120°C on request.
- Minimum degree of protection IP65.
- Built-in temperature sensors, on request.
PT – PTC – NTC – Thermostat.
- ATEX Constructions (See Multipoint E – Multipoint I series)



FLOATS

Tab.1



Material	Spansil – Butadiene - Acrylonitrile Copolymer										
Specific gravity	0,59	0,4	0,45	0,4	0,35	0,45					
Contact type	3	3	7D	3	3	7D	3	4	7	4	7
Max N. of contacts	1	1	3	4	4	4					
Max. bar	10	20	20	20	20	20					
Max. °C - Class	L = 105°C										
On request	M = 120°C										

ELECTRICAL CONTACTS

Tab.2

TYPE	POWER			VOLTAGE		CURRENT	
	VA	W		AC	DC	AC	DC
SPST 3	70	50		300	350	0,5	0,7
SPST 4	80	80		250	250	1,3	1,3
SPDT 7	60	60		230	230	1	1
SPDT 7D	20	20		150	150	0,5	0,5

ELECTRICAL OUTPUT

Tab.3

W1 IP65 Housing	W2 IP65 Housing	S1 – S2 DIN IP65 Plug	C1 – C2 – T1 Cable – Leads	P1 – P2 Cable-gland
Max. 5 terminals	Max. 18 terminals	S1 DIN43650 29x29 S2 DIN43650 15x15	C1 Cable L = 1,5m C2 Cable L = 3,0m T1 Leads L = 1,0m	P1 Brass IP68 P2 Polyamide IP67

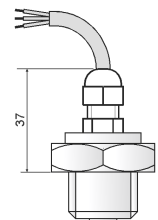
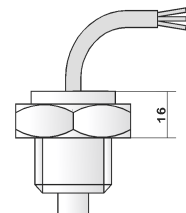
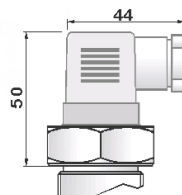
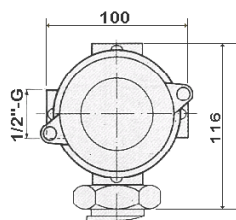
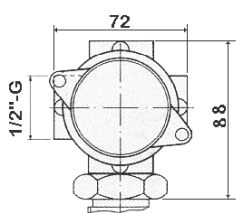

PROCESS CONNECTIONS

Tab.4

Installation from inside C- P-T output				Float type	Installation from outside – available thread and flanges											
06 1/8"	08 1/4"	10 3/8"	15 1/2"		15 1/2"	20 3/4"	25 1"	32 1 1/4"	40 1 1/2"	50 2"	FOHX Flange	FOPX Flange	DN Flange			
All type of floats All type of thread				B13	G-C-N	-	-	-	-	-	-	-	-			
				B15	-	-	G-C-N	-	-	-	-	•	•	-		
				B20	-	-	G	G-C-N	G-C-N	-	-	-	•	•	•	
				B28	-	G-C-N	G-C-N	-	-	-	-	-	-	-	-	
				B44	-	-	-	-	G	G-C-N	-	-	-	-	-	•
				B45	-	-	G	G-C-N	G-C-N	-	-	-	•	•	•	

Male thread

	C	N
Parallel UNI 228/1	Conical UNI 7/1	Conical NPT

Available materials

O	D	S
Brass	Anodized aluminium	AISI-316 On request

DN = Available materials

C	S
Steel	AISI-316 On request

FLANGES

Dimensions in mm.

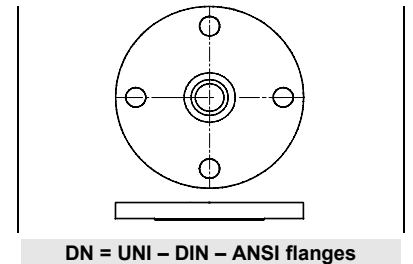
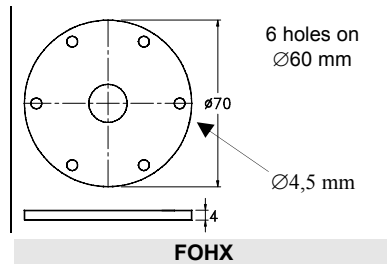
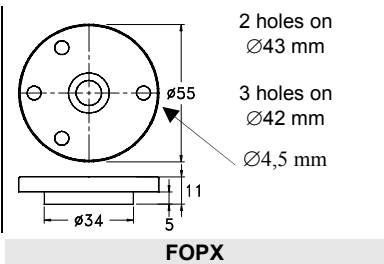

WIRING

Tab.5

I	Independent	Separately wired contacts	1	NO	Contacts status in no level conditions
C	Common	Common wired contacts	2	NC	
S	Custom	Contacts wired on customer request	3	SPDT	

SWITCH POINTS

Tab.6

The switch points L1 ÷ L4 are measured from the axis of the fitting or flange connection.
General tolerances on switch points ± 3 mm.

	Minimum distance in mm.						
	B13	B15	B20	B28	B44	B45	
A min.	60	55	60	60	80	60	60
A1 min.	60	55	60	60	80	70	75
B	25	20	20	25	40	35	40
C	-	35	40	-	75	65	75
D max. ▶	18	25	24	24	36	24	24
Contact type	3	3	3-7D	3-7D	4-7	3	4-7
Max. N. of contacts	1	3	4	1	4	4	

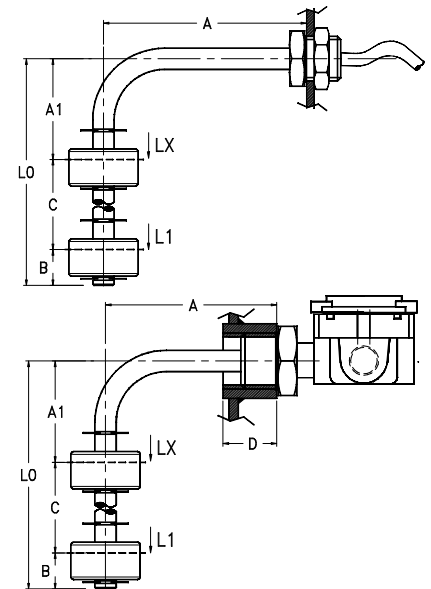

OPTION – Built-in temperature sensor

On request, it is possible to install a temperature sensor located at the bottom of the rod inside the instrument.

PT100 – PT1000	PTC	NTC	TRM (Thermostat)
EN 60751 – IEC 751	Resistance at 25°C ≤ 500 Ω	Resistance at 25°C 2-5-10-50-100 KΩ	40°C ÷ 120°C - 10°C step
Class B – (Class A on request)	Temperature 60°C ÷ 120°C	Precision ± 5% / ± 3% (on request)	Precision ± 5% Differential 10°C ± 4°C

NOMENCLATURE

L2	B45	4	0350/0100	O	25	G	O	W1	L	I22	L1+L4	
•												Number of contacts L1+L4
	•											Tab.1 Float
		•										Tab.2 Electrical contact
			•									- Length L0 in mm. / Length A in mm. (See drawing)
				•								Tab.4 Rod material
					•							Tab.4 Process connection dimension
						•						Tab.4 Process connection thread
							•					Tab.4 Process connection material
								•				Tab.3 Electrical output
									•			Tab.1 Temperature class
										•		Tab.5 Wiring and contact status
											•	Tab.6 Switch points (mm)